

**Our Largest Catalog EVER ...  
Lots of  
NEW PRODUCTS!**



**Supplying Growers, Gardeners and Groundskeeping Professionals since 1954**



**MASTER CATALOG 22**

**Handtools • Equipment • Woodlot • Spraying • Nursery • Parts, Sales & Service**



Our sales team reviews books to stay on top of what is happening in our industry. These are some recommended reference books and make for very interesting reading!

### Effective Vineyard Spraying

Comprehensive resource for experienced and novice growers and crop advisors, educators, and others. *By Andrew Landers*  
**BOK 0001**



### Christmas Trees

Resourceful book about growing and selling trees, wreaths and greens. *By Lewis Hill*  
**BOK 66566**

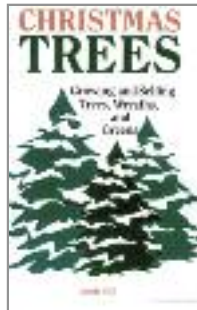

### The Pruning Book

Whether you're a professional gardener, a landscape veteran, or pruning for the very first time this essential reference gives you everything you need to master the subtle art of pruning. Lee Reich walks you through the process of pruning everything from ornamental trees and bushes to topiaries and bonsai. And all his insights are delivered with clear, straightforward prose and supported by 250 colorful photos and 135 drawings. *By Lee Reich*  
**BOK 071256** • 1.75 lbs.

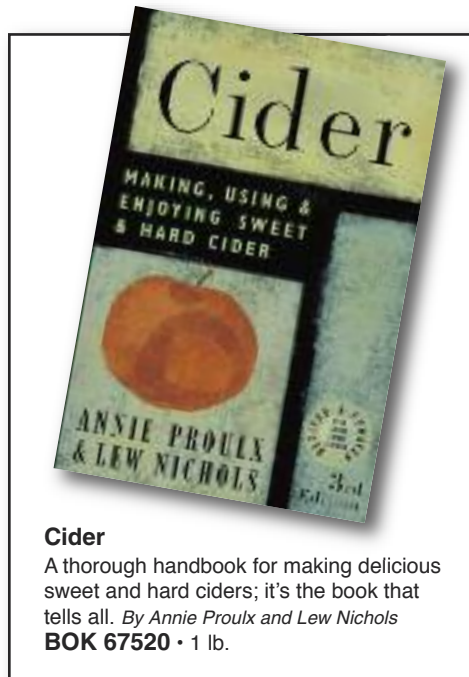

### Cider

A thorough handbook for making delicious sweet and hard ciders; it's the book that tells all. *By Annie Proulx and Lew Nichols*  
**BOK 67520** • 1 lb.



### The Garden Primer

The most comprehensive gardening reference (revised) including planning, pruning and extending the growing season. *By Barbara Damrosch*  
**BOK 12275**

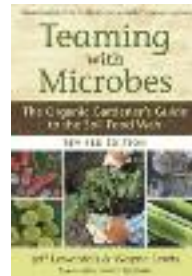

### Teaming with Microbes

A guide for organic gardening techniques and healthy soil. *By Jeff Lowenfels and Wayne Lewis*  
**BOK 689113**

## TABLE OF CONTENTS

BOOKS .....	1
RENTALS .....	2
PRUNERS .....	3-8
HARVEST SCISSORS/KNIVES .....	9
SICKLES/GARDEN KNIVES .....	10
DIGGING .....	11
SHEARING .....	12
MACHETES/AXES .....	13
GARDEN TOOLS .....	14
GRASS CUTTING .....	15
HEDGE TOOLS .....	16
LOPPERS .....	17-19
LONG ARM PRUNERS .....	20-21
PRUNING SAWS/FOLDING SAWS .....	22-24
POLE SAWS, POLE PRUNERS .....	25-29
SHEATHS/SCABBARDS .....	30-31
PNEUMATIC/ELECTRIC SHEARS .....	32-33
ECHO POWER TOOLS .....	34
SHOVELS/LANDSCAPE TOOLS .....	35-38
SHARPENERS .....	39
INSTRUMENTS .....	40
WALKING & HAND SPREADERS .....	41
MOWERS-GRILLO/TURFTEQ .....	42
VENTRAC ARTICULATING TRACTORS .....	43-45
MOWERS .....	46-50
PLATFORMS/TRANSPORTERS/DUMPERS .....	51
GOLDONI TRACTORS/UTILITY VEHICLES .....	52-53
NURSERY CARTS/TRAKMATS .....	54
LAND PREPARATION .....	55
FORKS/SNOWBLOWERS/GROOMERS .....	56
3 PT. & PULL SPREADERS .....	57
ROW MULCHERS/SPREADERS .....	58
LOG GRAPPLES/LOGGING ACCESSORIES .....	59
FIREWOOD PROCESSORS .....	60
PROCESSOR ACCESSORIES/WINCHES .....	61
SPLITTERS/GRAPPLES/CHIPPERS .....	62
LOGGING ARCHES/SKIDDING TONGS .....	63
WOODLOT HAND TOOLS .....	64
WOODLOT PERSONAL PROTECTION .....	65
REARS ORCHARD SPRAYERS .....	66-67
3 PT. & TRAILER ORCHARD/VINEYARD SPRAYERS .....	68
AIR ROW CROP SPRAYERS .....	69
REARS NIFTY SPRAYERS .....	70
DE-ICERS .....	72
SKID/TREE SPRAYERS .....	70-74
FEEDING NEEDLES .....	74, 93
3 PT. PAK TANKS .....	75
BOOM SPRAYERS .....	75-78
GREENHOUSE/CART SPRAYERS .....	79
12V SPRAYERS/FOAM MARKERS .....	80, 83
HANNAY HOSE REELS .....	81
SPRAYER CONTROLS/METERS .....	82-83, 94
HAND/BACKPACK SPRAYERS .....	84-85
SOLO SPRAYERS .....	85
WEED CONTROL SPRAYERS/WIPERS/HOODS .....	86-87
PUMPS/COUPLERS .....	88-89
TEEJET NOZZLES .....	90-91
SPRAY GUNS/WANDS .....	92-93
RELIEF/CONTROL VALVES .....	94-96
FITTINGS/COUPLINGS .....	96-97, 100-104
TANKS .....	97
HOSE .....	98-99
BANDIT TOOLS/HOSE CLAMPS .....	104
GAUGES AND INSTRUMENTS .....	76, 105
PERSONAL PROTECTION/GLOVES .....	106-112
TREE PROTECTION/SUPPORT .....	113
TRELLIS .....	114-115
PLANT TYING/GRAFTING .....	116-117
BIRD/DEER CONTROL .....	118-121
PICKING BUCKETS/BAGS/POLE PICKERS .....	122-123
FRUIT SIZING AND TESTING .....	124
LADDERS .....	124-125
ELEVATOR/GRINDER .....	126
WATER PRESSES/JUICE PUMPS .....	127
SANIFEEDS/GRATER .....	128
RACK AND CLOTH PRESS .....	129
UV PROCESSING .....	130-131
PACKLINE .....	132
CIDER UPGRADE .....	133
SANITIZING/STRAINING/BOTTLING .....	134
CIDER MAKING SUPPLIES .....	135
<b>PRODUCTS INDEX</b> .....	136
<b>MANUFACTURERS INDEX</b> .....	INSIDE BACK COVER
<b>TERMS &amp; CONDITIONS</b> .....	INSIDE BACK COVER

HAND TOOLS

EQUIPMENT

WOODLOT

SPRAYING

ORCHARD/NURSERY



### Country Wisdom Booklets

- BOK 66209** - Grafting Fruit Trees
- BOK 66222** - Making The Best Apple Cider
- BOK 66226** - Making Maple Syrup
- BOK 66228** - Great Grapes: Grow The Best Ever
- BOK 66289** - Making Homemade Wine
- BOK 66329** - Grow The Best Blueberries

**MORE BOOKS ... see pages 14, 112, 114, 122, 131 and 135**

## PRODUCT INDEX

### A

aglok 116  
airblast sprayers 66-69  
air compressors 33  
anemometer 40, 105  
anvil hand pruner 4, 6  
apple grater/ grinder 126, 128, 132  
apple parer/peeler 135  
aquacide 86  
arena grooming 56  
axe 13, 64

### B

backhoes/blades 55  
backpack sprayers 83-85  
ball valves 95-96  
bandana 112  
band-it tools & bands 104  
bird control 118-121  
bird net/tape 120-121  
blueberry rakes 124  
books 1, 14, 112, 114, 122, 131, 135  
boom control valve 82, 94-95  
boom parts 76, 90-91  
booms 75, 77-78, 80  
bow saw 22  
box rakes / blades 55  
brass hose adapters 100, 102  
broadcast spreaders 41, 57  
brooms 35, 38  
brush mower 42-43, 46-47, 50  
brusher washer 132  
budding knife 9  
budding strips 117  
bulb planters 14

### C

cable cutter 7, 114  
calc-an-acre 83  
calibration tester, containers 76, 105  
camlock fittings 103  
carriers 54  
carts, garden & tree 54  
centrifugal pumps 88-89, 129  
chain saws 32, 34, 65  
chaps 12, 65  
chipper, wood 62  
chlorine dispenser/test paper 134  
choker chain 59  
christmas tree tools 12-13  
cider equip upgrade 133  
cider makers supplies 134-135  
cider press cloth/racks 134  
cider presses 127, 129, 132  
cidersure 130-131  
cleaners 3, 22, 105, 135  
cobrahead 14  
constant flow valve 84  
controlled droplet applicator 87  
crimping tool 114  
cultivators, hand 14, 38

### D

deer soap/repellent 118  
de-icer sprayers 72, 79-80, 83  
de-icer spreader 41  
diamond sharpeners 39  
diaphragm pumps 89  
digging tools 11, 14, 35-38  
disposable coveralls 108  
disposable gloves 110  
driplok 116  
dumpers, power 51

### E

ear muffs/plugs 109  
edger 36  
edging shears 15  
electric pruner 32-33  
electric pumps 83, 88  
electric valves 95  
elevator 126, 128  
ergonomic pruners 3-4, 6-8  
ez reacher 40

### F

feed needle 74  
fence posts 113  
fertilizer spreader 41, 57  
finish mowers 48  
firewood processor 60-61  
fittings 83, 96, 100-102, 104  
flail mower 46-47  
flashlight 40, 112  
floral stem cutter 9  
flow meter 82-83  
flower knives/shears 3, 8-10  
foam marker 80  
folding saw 24-25  
folding scissors 9  
food grade hose 98, 135  
foot valves 103  
fork, hand 35-36, 38  
fork, tractor 56  
fruit picker 122  
fruit pressure tester 124  
fruit sizing plates 124

### G

garden hose 98  
garden supplies 14  
gauges 105  
gloves 110-111  
GPS guidance 82  
grafting knives 9  
grafting pliers 117  
grafting tools/wax 116-117  
grain scoop 35  
grape press 132  
grass shears/hooks 15  
grass stitcher 41  
ground mats 54  
ground shark 37

### H

hand pruners 3-8  
hand saws 12, 22-24  
hand warmers 112  
harvest pruners 8  
hedge shears 16  
hoes 14, 35-36, 38  
holsters 30, 65  
hori-hori 11  
hose 98-99, 135  
hose clamps/bands 104  
hose cutter 99  
hose fittings/couplings 100-104  
hose reel 81  
hose swivels 81  
hydraulic lopper/saw 33  
hydro seeder 72

### I-J

ice grips 112  
inspection roller table 132

### K

keg & cider dispenser 135  
knives 9-13  
knife sheath 13

### L

ladders 124-125  
lawn shears 15  
leaf blowers 34  
log carrier/splitters 62-63

log grapples 55, 62-63  
log winches 61  
logging chains & hooks 59  
logging trailers 59, 61  
long arm pruners 20-21  
loppers 17-19  
loppers, long reach 20

### M

machetes 13  
magnifiers 105  
mattocks 35, 38  
maul 64  
measuring wheel 40  
miracle tie 116  
mistblower, back pack 84  
mulch forks 36, 38  
mulch spreader 58

### N

needle nose shears 8  
nitrile gloves 110  
nursery tape 117  
nylon braided hose 98  
nylon hose inserts 100

### O

orchard ladders 124-125  
orchard mowers 46-49  
orchard sprayers 66-68

### P

packline equipment 132  
pakblast sprayer 68  
pakfork 56  
paktank sprayers 75, 78  
pakstak 56  
pallet forks 56  
peavey 64  
picking bags/buckets/straps 122-123  
picking head, pole pickers 122  
picks 35-36, 38  
pipe fittings 96, 100-101, 104  
pitch fork 36  
plows 42, 44-45  
pneumatic pruners/loppers/saws 32-33  
pole pruner 25-26  
pole saw blade 25, 27, 29  
pole saws/poles 25-29  
poly ball valves 95-96  
poly tanks 97  
portable pumps 88  
post hole diggers 35, 55  
powerblast sprayers 66-67  
power brooms 42, 44-45  
power edgers 34, 42  
power pruner 34  
power rakes 42, 44  
power trimmer 34  
press bags 127, 132  
press cloth 134  
pressure gauges 105  
pressure relief valves 94  
protective clothing 108  
pruner sheaths 24, 30-31  
pruners 3-8  
pruners, long arm 20-21  
pruning platform 51  
pruning saws 22-24  
pumps 83, 88-89, 127, 129  
pvc spray hose 98-99

### Q

quick coupling 103-104  
quick open valves 95

### R

radio head sets 109  
rain gauges 40, 105  
rainwear 108  
rakes, hand 35-36, 38, 124

rakes, tractor or truck 55  
ratchet loppers 18  
ratchet pruner 6  
refractometer 124  
repellent apparel, insect 112  
rentals 2, 44  
respirators 106-107  
roof rake 35  
root cutters 11, 36  
root feeders 74, 93  
rotary mower 48, 50  
row mulcher 58

### S

safety helmets 65  
safety glasses, face shields 65, 109  
sanifeed 128  
sap steady 131  
saw belt 30  
saw scabbards 23-24, 31  
saws 12, 22-24  
scissors 9  
scythe 15  
seeder 14  
sharpening stones 12, 39  
shearing knife 12  
sheaths 12-13  
shoe brushes/guards 112  
shovels 35, 37-38  
sickles 10  
skidding tongs 63  
sledge hammer 64  
snaths 15  
snowblowers 44, 56  
snow shovels 35  
sod cutter 11  
soil knife 11  
soil test kits 40  
spades 35, 37  
spin groomer 56  
spinning jenny 114  
sponge applicators 87  
spray booms 75, 77-78, 80  
spray guns 92-93  
spray hoods 86  
spray hose 98-99  
spray monitors/meters 82-83  
spray pumps 83, 88-89  
spray tanks 97  
spray tank cleaner 105  
spray tips 90-91  
spray valves/manual, electric 94-95  
spray wands 92  
sprayer calibrator 76, 105  
sprayer controls and controllers 82, 94  
sprayers:  
• 3 Point Hitch 68-69, 75, 77-78  
• Air Blast 66-69  
• Air Row Crop 69  
• ATV 80  
• Backpack 84-85  
• Boom 75, 77-78, 80  
• Cannon 69  
• Cart 79  
• Controlled Droplet Applicators 87  
• Compression 85  
• De-icer 72, 79-80, 83  
• Electric 72, 79-80, 86  
• Electrostatic 78  
• Greenhouse 79  
• Hand Held 87  
• Handpump 84-85  
• Hooded 86  
• Orchard 66-68  
• PakBlast 68  
• PakTank 75, 78  
• Powerblast 66-67  
• PulBlast 67  
• Skid 70-74, 80

• Tower 66  
• Trailer 66-68, 70, 78-79  
• Trombone 84  
• Turf 70, 73, 75, 77-79  
• ULV 78, 84, 86-87  
• Walk-behind 79, 86  
spreaders 41, 57, 58  
spring buckets 15  
stakes/stake driver 113  
stapler/ staples 114, 117  
stump grinder 43  
suction hose 98  
supertie 116  
syphon filler 134

### T

tank washing nozzles 82  
tanks 97  
tank fittings 96-97  
tapener/ tape 117  
temperature station 40, 105  
thermometer 40, 105  
thorn stripper 9  
tillers 56  
tip cleaning brush 105  
tire chains 59  
toe warmer 112  
tool bags/ belts 14, 30  
tower sprayers 66  
tracking wagons 54  
tractors 42-45, 52  
trakmats 54  
transcar 53  
transporters 51, 56  
tree carts/ carriers 54  
tree guard 113  
tree anchors/ guying 113  
tree stakes 113  
tree tie 116  
tree wrap 113  
treekote 117  
trellis hardware 114-116  
trellis lok 116  
trellis posts 113  
trowels 11, 14  
turf sprayers 70, 73, 75, 77-79  
two wheel tractor 52  
tying material 116, 117

### U

ultra violet processors 130-131  
Valve, spray 94-96  
vegetable knives 10  
velcro tie 116

### W

walk behind spreaders 41  
walk behind tractors 42, 52  
water presses 127  
water sensitive paper 105  
weed boom 75  
weed cutter 15  
weed wiper/kits 86-87  
weeders 10, 14, 38  
weedseeker 86  
wheeler saw 22  
whiskey barrels, used 135  
winches, logging 61  
wind meters 40, 105  
windfoil boom 86  
wire cable/accessories 114  
wire cutters 7, 114  
wood kegs 135  
wood splitters 60, 62  
wreath making pruners 8, 12

### X-Y-Z

zong gun 120

## Manufacturers Index

### A

Ace Pump 88  
Agfast 115-116  
Agtec 69  
Allen 26  
A. M. Leonard 113  
Apollo 95  
Aquacide 86  
ARS 3, 8-9, 12, 14-16, 20-27, 30, 39

### B

Back-to-Basics 40, 112, 135  
Bahco 4, 8-9, 12-17, 19, 22, 29, 39, 63, 64  
Baldwin 124  
Band-It 104  
Banjo 96-97  
Barnel 6, 8-10, 12-16, 18-20, 23-25, 27, 29-31, 38-39, 54  
Barteaux 10, 13  
Bedford 118  
Bertolini 51  
BF Products 114  
Bird Gard 119  
Bird-X 118, 120  
Bobbex 118  
Bond 122  
Boss 134  
Brush King 12  
Bug Band 112  
Bush Hog 50, 55  
Buzz Off 112

### C

Callahan 134  
Campagnola 32-33  
Carrarospray 68  
Castellari 5, 12, 17  
Cider Hill 117  
Clark 113, 117  
Cobrahead 14  
Cold Steel 13, 64  
Comet 88  
Cooke 116-117, 120  
Corona 6, 8, 13, 15, 18, 20, 22, 24, 26, 29-30, 38, 64  
CTI 56  
Cutwell 26

### D

Day Equipment 134, 135  
DB Smith 85  
Delta 63

Dinowood 65  
Dixon Valve 100-105  
DMT 39  
Donegan Optical 105  
Duckbill 113  
Durand Wayland 68  
Dwyer 40

### E

Earthway 14, 79  
Echo 34, 65, 84, 88  
Edmont 108, 110  
Edwards 56  
Elvex 65, 109  
ESS 78  
EZ Reacher 40  
EZE-LAP 12, 39

### F

Fanno 22  
Fairview Fittings 101, 103  
Farwell's 117  
Felco 7-9, 12, 17-18, 22, 24, 30, 33, 114  
Ferri 46  
Fischer 48-49  
Fingerlakes 114  
Flo-Couplings 95, 98, 103, 135  
Food-Flo 103  
FPE 130-131  
Fred Marvin 29  
Frensch 114, 117  
Friend 30, 122-123  
Fruit Picking Equip 122

### G

G&G Mfg 88  
Gardman 113  
Gibbs 135  
Gilmour 98  
Ginsburg 118  
Goldoni 52-53  
Gomark 127  
GPI 83  
Grainger 103, 113  
Grass Stitcher 41  
Great Plains Mfg 63, 65, 80, 88  
Green Garde 83-84, 93, 99, 102  
Greenlee Fairmont 33  
Grillo 42

### H

Hamilton 93-94  
Hannay Reels 81

Hickok 18  
Hubbard 124  
Hudson 83-84  
Hypro 83, 88-89, 93, 96, 100, 102, 105

### I-J

Iron & Oak 62  
Jacto 68-69  
Jaffrey 132  
Jameson 27-29  
Jasper Enterprises 113  
JDR Enterprises 113  
JMS 59  
John Bean 68, 74, 88, 93-94  
Judd Tree Guard 113  
JWB 118

### K

Kasco 106  
Kencove 114-115  
Kimberly Clark 108  
Kinco 110-111  
Kingston 74, 95  
Klorman 134

### L

La Crosse 40, 105  
LaMotte 40, 134  
Lamson 12-13  
Lancman 127  
Lanco 58  
LD Carlson 135  
Lee 113  
Limb Lopper 33  
Logrite Tools 63-64

### M

MacKissic 79  
Maibo 32-33  
Maine Garden Prod 14  
Mankar 87  
Marchant 125  
Maschio 55  
Max 117  
McGill 98, 135  
Metallic 124  
Micro-Trak 83  
Mid West Tech 82  
Millcreek 56  
Mill Valley Supply 114  
MS 69, 72-73, 77, 79-80  
Myers 88

### N

National Clothes Pin 116  
NTech 86  
NY Glass 103

### O

OCC 65, 112  
Orchard 9, 14, 22, 74, 122, 124, 126-129, 132, 134, 135  
Orchard Valley Supply 113-114  
Oregon 65  
Osatu 85

### P-Q

Patchen 86  
Peavey 28-29, 63-64, 122  
Perfect 46, 48  
Pica 5  
Pillon 51  
Pioneer 104  
Polmac 82  
Porter Ferguson 18, 29  
Precision Lab 105  
Prize Lawn (PSB) 41

### R

RadTech 56  
Rears 47, 56, 66-68, 70-71, 75, 78-80, 95, 98, 102  
Redball 86  
Richway 80  
River City 108  
Rogers 86  
Rolatape 40

### S

Scrusher 112  
SETS 43, 72, 106-107, 134  
Seymour 13, 15, 26, 35, 64, 114  
Shaver 63  
Shurflo 83  
Sideswipe 87  
Silky 23-25  
Sitrex 48, 57  
Slip-N-Snip 9  
SmartNet 121  
Smuckers 87  
Snapcut 6, 27-29  
Snyder 97  
Solo 84, 85  
Southern Forestry 12  
SP Systems 85  
Specialty Mfg Co 95  
Sperian 106-107, 109

Spraying Systems 82, 92, 94-95, 105  
Spot On 76, 105  
Spyker Spreaders 41  
Sta-For 5  
Sumio 14  
Sundown 56  
Super Sponge 87

### T

Tajfun 60-61  
Taylor 40  
TeeJet 76, 82, 90-91, 94-95, 105  
Tomlinson 135  
TrakMats 54  
TRG 38  
True Friends 16, 84-85  
Turf Teq 42  
Tyz-All Plastics 116

### U-V

UDOR 88  
Vaca 18  
Velcro 116  
Ventrac 43-45  
Vertex 14  
Vicon 57  
Vicon-Brazil 57  
Volpi 33, 87  
VWR Scientific 124

### W

Wagner 124  
Wallenstein 62  
Wallingford's 59  
Walter E. Clark & Son 113, 117  
Weaver 12, 30-31, 65  
Webbing Industries 116  
Weedseeker 86  
Wells & Wade 122  
West County Gloves 111  
Wheeler 22  
Wilcox 11  
Wildlife Control 120  
Wilson Irrigation 115-116, 124  
Windfoil 86  
Worksaver 55, 62  
WWMfg 11, 36-37, 54, 113

### X-Y-Z

Yaktrax 112  
York 55  
Zeller & Son 117  
Zenport 10-11, 116  
Zon 120

## What's New?

### Many things! We ...

- expanded our bladder presses with new stainless steel models (page 127)
- are offering a new line of loppers (page 17) and pruners (page 5) from Casterelli
- have chosen a few good reference books that we personally use and our customers refer to as their "bibles" (page 1)
- found Smart Net Systems that will save you time and money (page 121)
- expanded our flail mower representation (pages 46 & 47)



Look for this symbol throughout the catalog that lets you know about a new product!

Tucked into a town in the hills between the Berkshires and the Connecticut River, Conway is easily accessible from Route 91. We struggle through the multiple weather patterns of New England with our neighbors, and understand what is needed to make the most of our terrain. Our customers depend on us to research products and offer what we believe are the right products for their particular application. Our commitment to you remains as strong as it was in 1954, when Norm & Thelma French started Orchard Equipment and Supply Company in Burlington, Connecticut. The company moved to Conway in 1967, and built a large showroom filled with tools, parts and equipment. If you find yourself in western Massachusetts, we hope you will stop in! We value your loyalty and your business.

# FOR RENT

- AG Equipment
- When you need it
- Getting the advantage

*At times you need a piece of equipment for a short period of time. Having access to a rental is all you need and OESCO has it! These key pieces of equipment will help you get the job done.*

- Call us for more information



**Transcar**

A great vehicle for fitting into tight quarters when you need accessibility of a tri-lateral dump. Ideal for barns, trails and farms. Rentals by the day or week.



**VENTRAC**

**WITH ATTACHMENTS!**  
Many to choose from.  
Give us a call, we're sure we can help!

**VENTRAC MOUNT SYSTEM**



A perfect solution to unexpected inclement weather conflicting with landscaping installations. Also used at events/worksites where you need to keep the lawns intact. 44" x 8' x 1/2"



**TURF TEO**  
BRUSH CUTTER

For clearing under brush & saplings, clearing trails and keeping small fields cut.



**B**  
**BERTOLINI**  
TRANSPORTER

In a tight spot with a heavy load? The Bertolini Transporter may be just the unit to get you out of a jam.

**LANCO**

Save time getting mulch around your crops with a row mulcher rental. Spreads about 3' of mulch between 1/2" and 8" deep; holds 5.33 cubic yards heaped. Good for berry and vegetable crops, vineyards and orchards. PTO driven.



# What makes **ARS** pruners different?



- 1. Sharper** - More aggressive bevel angle (64°) on the precision ground blades (most pruners are 50°)
- 2. Superior Cutting Leverage** - Offset blade angle to maintain natural hand strength
- 3. Expert Hardening** - No one hardens blades better than ARS. Edges are not only sharper, but keep their edge longer.
- 4. Expert Blade Treatment** - Blades are hard chrome plated to keep rust, dirt and sap buildup away.
- 5. True Single Handed Operation** - Squeeze the handles to open. Easy to close.
- 6. Ergonomic Design** - Simple solid die cast aluminum construction is shaped to fit the hand perfectly. Lighter weight, better balanced and longer lasting.

## V SERIES

### The ARS Signature Heavy-Duty Pruner

- Recommended for all types of pruning
- All metal construction
- Lightweight and perfectly balanced
- Replaceable, hard chrome plated blade
- Cast aluminum handle with non-slip grip
- Locking latch releases by squeezing the handle
- Spare parts available



### VSR Series with rotating Handle

The popular V-Series is available with a rotating handle. A rotating handle, minimizing fatigue and strain, has been added to the VS8 and VS9 blade set and spring along with the squeeze-to-open action.

- ARS HP-VS8R** - Length 8" • 8 oz.
- ARS HP-VS9R** - Length 9" • 9.3 oz.



### LIGHTWEIGHT BYPASS PRUNER

- Recommended for smaller hands
- Hard chrome plated blade or black finish blade
- Non-slip lightweight grips



**130DX**  
Light pruner fits smaller hand, bypass chrome blade. Colors are random when ordering by the box.  
**ARS HP-130DX** - 7.3" long • 5.3 oz.

### MULTI-PURPOSE SHEARS

- Gardening, pruning, flower arranging, crafts
- Perfect for hoof trimming
- Straight, chrome plated blade
- Both blades sharpened
- Non-slip lightweight grips



**140DX**  
Colors are random when ordering by the box.  
**ARS HP-140DX** - 7.5" long • 5.3 oz.

### S SERIES

#### Traditional Japanese Pruner

- Recommended for very heavy-duty pruning
- Drop-forged, precision ground blade for longer life and better leverage
- All metal construction
- Hard chrome plated blade



For smaller hands  
**ARS HP-120S7** - 7" long • 7.3 oz.



**ARS HP-120S8** - 8.2" long • 8.4 oz.

### EURO STYLE PRUNER

- Comfortable, Euro style ergonomic handle
- Hard chrome finished, high carbon steel blade
- A GREAT PRICE!



**ARS HP-120EU** - 8.4" long • 7.9 oz.



**140LDX**  
Same as 140DX with longer blade. White handle only.  
**ARS HP-140LDX** - 8" long • 5.6 oz.

### Blade Cleaner

Easily removes sap and dirt with just a spray and a wipe.

**ARS GO1** - 3.8 fluid oz.





# Ergonomic Pruners for More Comfortable Pruning

Improve your comfort, security, health and efficiency

This modular, ergonomic pruner is the result of five years of scientific research and field testing. This design provides two major advantages - **LESS FATIGUE** at the end of the day and a **LONGER & MORE PRODUCTIVE** working life.

A favorite of professionals pruning fruit & landscapers



The **LATERAL** and **VERTICAL INCLINATION** of the tool body allow your wrist to stay in a neutral position, reducing strain and maximizing wrist and forearm power.

- Improved Comfort
- Improved Health
- Improved Efficiency

See catalog price list or visit our website at [www.oescoinc.com](http://www.oescoinc.com) for price and sizing information.

Available for **Right-** or **Left-Handed** Users.

Assembled Units Stocked

## PX Type PXR Type



Fixed handle ergonomic pruner.

### PX Type (Fixed handles)

- BAH PX-S2 - Right hand, small handle, 3/4" cut • 9 oz.
- BAH PX-M2 - Right hand, medium handle, 3/4" cut • 9 oz.
- BAH PX-M2-L - Left hand, medium handle, 3/4" cut • 9 oz.
- BAH PX-M3 - Right hand, medium handle, 1 1/4" cut • 9 oz.
- BAH PX-L2 - Right hand, large handle, 3/4" cut • 9 oz.
- BAH PX-L3 - Right hand, large handle, 1 1/4" cut • 9 oz.



Rotating handle ergonomic pruner.

### PXR Type (Rotating handles)

- BAH PXR-S1 - Right hand, small handle, 5/8" cut • 10 oz.
- BAH PXR-S2 - Right hand, small handle, 3/4" cut • 10 oz.
- BAH PXR-M2 - Right hand, medium handle, 3/4" cut • 10 oz.
- BAH PXR-M2-L - Left hand, medium handle, 3/4" cut • 10 oz.
- BAH PXR-M3 - Right hand, medium handle, 1 1/4" cut • 10 oz.



### P121 TOOL

Metal handle design in three sizes. Traditional bypass blade.

- BAH P121-18-F - 1/2" capacity, 7" long for small hands • 8 oz.
- BAH P121-20-F - 3/4" capacity, 8" long • 9 oz.
- BAH P121-23-F - 1" capacity, 9" long • 12 oz.



### P126 GENERAL PURPOSE

General purpose, bypass pruner, steel handles, no replacement parts.

- BAH P126-22-F - 3/4" capacity, 8 1/2" long • 10.9 oz.



### P138 ANVIL PRUNER

Anvil pruner for tough dead wood. Steel handles, double bevel on blades, aluminum anvil.

- BAH P138-22-F - 3/4" capacity, 8 1/2" long • 10 oz.



### P110 GENERAL PURPOSE

Stamped steel handles, bypass blade, front wire clasp. Heavier duty than P126.

- BAH P110-20-F - 3/4" capacity, 8" long • 11 oz.
- BAH P110-23-F - 1" capacity, 9" long • 14 oz.



# New Italian Pruners

## Cutting edge pruning technology from Castellari of Italy

ITALIAN & SWISS PRUNERS

### Anvil Pruners



**NEW**

Classic curved anvil pruner with forged aluminum handles and counter blade. 8" OAL  
**CAS UNIVERSALE** • 7.2 oz.



**NEW**

Classic curved anvil pruner with forged aluminum handles and counter blade. Ergonomic handle further reduces the impact to hand and wrist when cutting. 8" OAL  
**CAS ERGONOMIC** • 7.6 oz.

### Dual Blade Pruners



**NEW**

Dual blade pruner allows the two cutting blades to meet precisely, allowing for a very close, clean cut that does not crush the bark. Very popular for stone fruit. 8" OAL  
**CAS LADY-II** • 8.1 oz.



**STA 950.20.12** • 12 oz.

**NEW**



Manufactured by Sta-For of Maniago, Italy this dual blade pruner has all the features of the Castellari Lady II but has a heavy duty forged carbon steel construction and a single taper blade.

Innovative anvil style and dual blade pruners used widely in commercial orchards and vineyards in Europe.

- Forged aluminum handles and counter blade
- Extremely lightweight and durable - tools are 7.2 - 8.1 oz.
- Unique curved counter blade design minimizes shock to hand and wrist when cutting
- Dual blade pruner design is especially valuable in stone fruit crops - minimal injury at the cutting point
- Lots of great features at an affordable price

*See the new Castellari anvil loppers on page 17!*

*From their neighbors in Switzerland...*

### PICA / NAEGELI

Special designed cutting system saves effort. Bypass blade is hooked, cutting blade is straight. Comfortable handles and spring action.



**2L**

Blade & hook replaceable. Good for fruit. 7" long  
**PCA 005P2P** • 7.2 oz.



**3L**

Replaceable blade. Blade & hook are narrower than 2L. Light duty fruit, gardening tool, ergonomically pleasing.  
**PCA 005P3** • 6.4 oz.



### Professional Ergonomic Series

#### For smaller hands

3/4" capacity, 7" length. Forged aluminum body, TPR coated non-slip handle, 2 position lock (1/2 and full) mechanism.  
**BAR B307** • 7.6 oz.



Same as above with rotating handles.  
**BAR B317** • 9.3 oz.



#### For medium to large hands

1" capacity, 8" length. Forged aluminum body, TPR coated non-slip handle, 2 position lock (1/2 and full) mechanism.  
**BAR B308** • 8.2 oz.



Same as above with rotating handles.  
**BAR B318** • 9.8 oz.



### Utility Shears

All with TPR/metal handle  
 2 position lock, 1/2 and full open

7" Lightweight chrome secateur. Cuts 1/2" green wood.  
**BAR B7** - small • 5.8 oz.



8" Lightweight chrome secateur. Cuts 3/4" green wood.  
**BAR B8** - large • 6.8 oz.



7" Lightweight chrome twin secateur (both blades sharpened).  
**BAR B1400** • 5.6 oz.



8" Lightweight chrome twin secateur (both blades sharpened).  
**BAR B1400L** • 6.6 oz.



**NEW**

Already a **BEST SELLER!**

**BAR B175** - 8 1/4" OAL  
 11.1 oz.



Bypass pruner. Cuts up to 3/4", Heavy duty steel handle, double bumper, replaceable blade. Colors are random.



### BYPASS

Very Popular



8", 3/4" capacity. Nice sharp, diecast aluminum utility pruner. Replaceable blade and spring. Good alternative lower cost tool!  
**BAR B200** • 9 oz.

Very Popular



8", 1" capacity. Drop forged aluminum heavy duty, anodized finish. Designed to compete with European brand pruners. Cuts up to 1" capacity wood. Replaceable blade & spring.  
**BAR B300** • 10 oz.

### RATCHET



8", cuts up to 3/4", curved ratchet blade aluminum pruner.  
**BAR B888** • 3.7 oz.



8", cuts up to 3/4", straight blade ratchet pruner with rotary handle.  
**BAR B575** • 4 oz.

### ANVIL



Designed for dry and woody growth 3/4" capacity, replaceable blade, brass anvil.  
**COR AP-3110** • 10 oz.



### SNAP-CUT 18T

Pocket-size pruner with anvil action blades. Easy-cutting Teflon-S coated blades. 6 1/2"  
**SNC 18T** • 8 oz.



### SNAP-CUT 19T

Anvil action pruner with easy-cutting Teflon-S coated blades. 8"  
**SNC 19T** • 16 oz.



**BP 3130** Designed for smaller hands  
 1/2" capacity, resharpenable bypass blade.  
**COR BP-3130** • 8 oz.



**BP 3160** Good general purpose pruner  
 3/4" capacity, resharpenable bypass blade.  
**COR BP-3160** • 10 oz.



**BP 3180**  
 1" capacity, replaceable, resharpenable blade.  
**COR BP-3180** • 15 oz.

## "STATE-OF-THE-ART" MANUAL PRUNING SHEARS

- Recommended for all types of pruning
- Precise blade adjustment
- Cushion shock absorber
- Sap groove
- Forged aluminum alloy handles
- Wire cutting notch
- High resistance
- Performance head
- Spare parts available

### FELCO 2



Classic professional model, riveted anvil blade. Length - 8.5"  
FEL F-2 • 8.5 oz.

### FELCO 11



Classic new generation model, screwed anvil blade. Length - 8.3"  
FEL F-11 • 8.6 oz.

### FELCO 100



F11 pruner with cut and hold blade, screw mounted. Length - 8.25"  
FEL F-100 • 8.5 oz.

### FELCO 6



Designed for small hands, light and compact, tapered cutting head. Length - 7.7"  
FEL F-6 • 7.4 oz.

### FELCO 8



Ergonomic shape, angled cutting head. Length - 8.3"  
FEL F-8 • 8.6 oz.

### FELCO 9



For LEFT HANDERS. Angled cutting head. Length - 8.3"  
FEL F-9 • 8.6 oz.

## MANUAL PRUNING SHEARS FOR ONE OR TWO HANDS

- Recommended for pruning thick branches
- Extra long left handle

### FELCO 13



Angled cutting head. Length- 10.6"  
FEL F-13 • 10.9 oz.

## "STATE-OF-THE-ART" PRUNING SHEARS WITH REVOLVING HANDLE

- Recommended for heavy and prolonged pruning
- Revolving handle spreads force over 5 fingers, preventing tendonitis and inflammation
- Handles with a shock absorber and cushion to protect the wrist.
- Precise adjustment of blade and anvil blade.
- Sap groove
- Forged aluminum alloy handles
- Spare parts available

### FELCO 7



High performance tool, angled cutting head. Length - 8.3"  
FEL F-7 • 10.2 oz.

### FELCO 10



High performance tool, angled cutting head. For LEFT HANDERS. Length - 8.3"  
FEL F-10 • 10.2 oz.

### FELCO 12



High performance tool, for smaller hands, tapered cutting head. Length - 7.9"  
FEL F-12 • 9.3 oz.

## BASIC MANUAL PRUNING SHEARS

- Recommended for occasional pruning or gardening
- Blade and anvil aligned with bolt and nut
- High performance cutting head

### FELCO 4



Standard tool, riveted anvil blade, forged aluminum alloy handles. Length - 8.3"  
FEL F-4 • 7.8 oz.



### FELCO 31



New adjustable anvil, beveled blade, forged aluminum alloy handles.  
FEL F-31 • 7.9 oz.

### FELCO 5



Basic model, steel handles. Length - 8.9"  
FEL F-5 • 10.9 oz.

### FELCO CP



For workshops, florists, mechanics, DIY hobbyists and domestic use. Ideal for professionals in repair and shipping. Cut metal, net, wire, rubber, leather, plastic. Hardened steel blades. Length - 8.1"  
FEL C-P • 10.2 oz.

### FELCO C7



For cutting wire and cable, spring wire up to .1" and cable up to 3/16". Length - 7.25"  
FEL C-7 • 9.5 oz.

### FELCO C9



Triangular cut allows the wire rope to be cut and not crushed. Cuts wire rope up to 5/16". Length - 13"  
FEL C-9 • 26.9 oz

Many other cable cutters available, 2 hand models for up to .5" diameter rod & cable. Other specialty cutters & hoof clippers available by special order.

## PARTS FOR FELCO PRUNERS

### CUTTING BLADE



- FEL 2-3 • Fits Felco 2, 4, 11
- FEL 5-3 • Fits Felco 5
- FEL 6-3 • Fits Felco 6, 12
- FEL 7-3 • Fits Felco 7, 8
- FEL 9-3 • Fits Felco 9, 10
- FEL 13-3 • Fits Felco 13
- FEL 30-3 • Fits Felco 30 (cutting blade)
- FEL 30-4 • Fits Felco 30 (anvil blade)

### SPRING PACK



- FEL 2-91 • Fits Felco 2,4,7,8,9,10,11
- FEL 6-91 • Fits Felco 6,12
- FEL 5-91 • Fits Felco 5,13
- FEL 30-91 • Fits Felco 30

### BOLT & NUT SET



- FEL 2-90 • Fits Felco 2
- FEL 4-90 • Fits Felco 4
- FEL 5-94 • Fits Felco 5
- FEL 6-90 • Fits Felco 6,11,12
- FEL 7-90 • Fits Felco 7, 8, 9,10,13
- FEL 30-90 • Fits Felco 30

### REPAIR KIT



- FEL 2-92 • Fits Felco 2,6,7,8,11,12,13
- FEL 30-92 Fits Felco 30

### SHOCK ABSORBER SET



- FEL 2-93 • Fits Felco 2,6, 7, 8, 9, 10, 11, 12, 13

Additionally ... ALL Felco parts are available for all pruners.

## Sharp Lightweight Snips

### LIGHT DUTY



Lightweight Harvesting Shears for Flowers, Fruits & Herbs

Designed by Felco. Made in Italy.

#### F300

Lightweight yet strong flower and herb gathering shear. 7 1/2" long.

FEL F-300 • 4.2 oz.



#### F310

Grape and general fruit harvesting shear, lightweight for easier handling. 7 5/16" long.

FEL F-310 • 3.9 oz.

### STAINLESS STEEL



#### A3001S

2" stainless steel blades (easy to sterilize). Pointed needlenose. deep sap groove. 7 1/2" long.

BAR A3001S • 3.8 oz.



#### A3002SC

2" stainless steel curved needlenose blades, deep sap groove. 7 1/2" long.

BAR A3002SC • 3.8 oz.



#### V3001S

2" stainless steel blades. Pointed needlenose. 7 1/2" long.

BAR V3001S • 3.9 oz.

## Our Best Lightweight Sellers ...



#### ARS 300L

Light duty. High carbon, pointed, strong needlenose 2" straight blade. 7 1/2" long.

ARS HP-300L • 3.5 oz.

Stainless steel blade

ARS HP-300L DX • 3.5 oz.



#### ARS 310

Light duty. High carbon, curved, rounded nose. 1 1/4" blade, 6 1/2" long.

ARS HP-310 • 3.2 oz.



#### V3000

2" carbon steel blade. Pointed needlenose. 7 1/2" long.

BAR V3000 • 3.9 oz.

#### A3000

2" straight high carbon blade. TPR non-slip handle, one handed lock, deep sap groove. 7 1/2" long.

BAR A3000 • 3.2 oz.

#### B120

Anvil fruit harvester for high value fruit crop where stem puncture is a concern. Two sizes available.

BAR B120 - 4 1/2", small anvil • 3.2 oz.

BAR B120L - 5 1/4", large anvil • 4 oz.

#### B3600S

6" forged mini pruner with replaceable blade. Drop forged.

BAR B3600S • 5.6 oz.



#### FS 4310

House plant shear designed for very small hands. Forged 1 1/4" needlenose blades. 5" long.

COR FS4310 • 6 oz.



#### P128

Lightweight snips for harvest. Fiberglass handle.

Opens to 1.3". 7 1/2" long, 1/4" capacity.

BAH P128-19 • 4 oz.

BAH P129-19 - 11° angled blade (not pictured) • 4 oz.

## Our Best Medium Duty Seller ...



#### P123

Medium duty. Harvest Snips.

Fiberglass handle, 7 1/2" long, bypass blade. Opens 1.5".

Supplied with poly holster.

BAH P123-19 • 3.2 oz.



### MEDIUM DUTY



#### B3500

Medium duty, narrow 2" carbon steel blade, steel handle. 7 1/2" long.

BAR B3500 • 5.6 oz.



#### ARS SE45

Palm action garden/flower shear with plastic handles. 1 3/4" straight blade. 7" long. Replaceable blade.

ARS HP-SE45 • 3.2 oz.

#### ARS SE65

Same as SE45 with longer blade. 2 1/2" blade, 8" overall. For grass, leaves, cultivating onions.

ARS HP-SE65 • 3.2 oz.

### HEAVY DUTY



#### FS 4350

Thinning shears with forged straight 2" needlenose blades. 8" long.

COR FS4350 • 8 oz.

#### AG 5030

Original grape shear. Curved, forged 2" blades for harvest and thinning fruit. 8" long.

COR AG5030 • 8 oz.

## Palm Fit Ergonomic Fruit/Floral/Garden Shears from BARNEL



- Ergonomic palm contour fit
- Comfortable, adjustable finger ring
- Lightweight, 3.3 oz.
- Stainless steel blades
- 1/4" capacity



Straight needlenose, 6" OAL  
BAR BP3001S



Curved, blunt nose, 5" OAL  
BAR BP3100SC



Bypass Shear, 6" OAL  
BAR BP3600S

**HARVEST SCISSORS**

Thin, stainless steel blades with soft cushioned grips. Right or left hand use. 6 1/2" long for grapes and horticulture. Choose straight or tilted head.



**NEW**

Straight head  
**BAR B3200** • 2 oz. *or* **ARS SS-320DXT**



**NEW**

Tilted head  
**BAR B3200T** • 2 oz. *or* **ARS SS-320DXM**

**FLORAL/UTILITY SCISSORS**

Stainless steel utility scissors. Stronger than the harvest scissors. Straight blade with serrated edge. Soft PVC handles. For flowers, bonsai, crafts. Includes snap-on sheath

**NEW**

Assorted random colors  
**BAR B3300** - 6" long • 2 oz.



**ARS SS-3000** - 6" long • 2 oz.

Precision of a shear with the comfort of scissors.

Hardened stainless. Comfort grips feature a toothed stem crusher to prepare cut flowers for arrangements. 6" long.  
**ARS SSK-1294** • 3.2 oz.



**UTILITY/CRAFT SCISSORS**

Stainless steel blades. Soft grips.



8" long (pictured on right)  
**BAR B3400** • 2.7 oz.  
*or*

7.5" long (pictured on left)  
**ARS SS-340HT** • 3 oz.

**BARNEL USA BARNEL KNIVES**



**STATIONARY GRAFTING KNIFE**

High carbon 1 3/4" blade, 4" hardwood handle with brass rivets.  
**BAR B6850** - 6 3/4" long • 1.6 oz.



**STATIONARY BUDDING KNIFE**

High carbon 2 1/4" blade, 4" hardwood handle with brass rivets.  
**BAR B6830** - 6 1/4" long • 1.6 oz.



**FOLDING GRAFTING KNIFE**

High carbon 2 1/4" blade and a select hardwood handle with brass rivets and liner. SUPERIOR QUALITY knife. "Solingen" design.  
**BAR B6050** - 6 1/4" long open • 2.4 oz.



**FOLDING BUDDING KNIFE/BARK LIFTER**

Superior quality 1 3/4" blade, hardwood handle with brass rivets. "Solingen" design.  
**BAR B6410** - 6 1/4" long open • 2.4 oz.



**HORTICULTURAL/CRAFT SCISSORS**



8" stainless steel scissors for flowers and other applications. Soft grips, extra fine tip. 2" blade. Heavy duty application.  
**BAR B20SS** • 3.2 oz.

**FOLDING SCISSORS**



To open - pull handles apart, fold handles down.  
To close - Fold blades back into handle slots, push together.



Stainless steel blades. Chrome plated handles. Folds, safety closed.  
**ORC SNS1** - 4" long • 4oz.



**LEAF SHEAR**

4.5" long, carbonated blades, chrome plated aluminum grips. 11" OAL  
**ARS SSK-N207** • 11.2 oz.

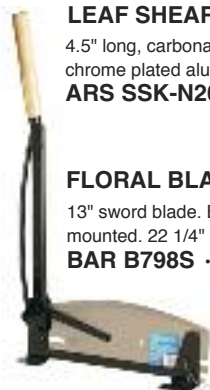

**FLORAL BLADE CUTTER**

13" sword blade. Bench mounted. 22 1/4" long  
**BAR B798S** • 7 lbs.

**THORN/LEAF STRIPPER**

4" thorn/leaf stripper. Comfortable handle.  
**BAR B5000** • 3.2 oz.



**VICTORINOX FLOWER TOOLS FOLDING KNIVES** - 2 1/4" blade, 3 1/4" red handle.



**FEL 39-050** - straight blade • 2 oz.



**FEL 39-060** - curved blade tip • 2 oz.



**FLOWER KNIVES**



**ARS KN-FN6TRP** - Straight folding blade



**ARS KN-FN6MRP** - Curved folding blade



**FOLDING GRAFTING KNIFE**



Carbon steel blade & brass spatula folds into plastic handle.  
**BAH P11** - 7 1/4" long • 2.4 oz.

**GENERAL PURPOSE KNIVES**

General purpose. Straight blade. Thin, Sheffield Stainless Steel blade and shackle. 7" long, 2 3/4" blade.  
**BAH KAP-1** • 3.2 oz.



General purpose knife. Curved, folding blade, stainless steel blade and shackle. 6 3/4" long, 2 1/2" blade.  
**BAH KGP-1** • 3.2 oz.



Professional pruning knife. Curved, high carbon steel blade. Folds into plastic handle. 7 3/4" long, 3" blade.  
**BAH P20** • 4 oz.



BARNEL .USA



**Ergonomic Handle Design for Comfort**

3" stainless steel blade. 7.5" OAL  
Landscape/harvest knife.  
**BAR BLK751** • 1.7 oz.



1.75" stainless steel blade. 7" OAL  
Harvest knife.  
**BAR BLK752** • 1.5 oz.



3" serrated stainless steel blade. 7.5" OAL  
All purpose knife.  
**BAR BLK758** • 1.7 oz.



1.75" serrated stainless steel blade. 7" OAL  
Landscape/harvest knife.  
**BAR BLK750** • 1.5 oz.

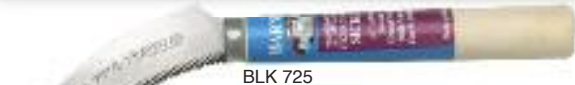

BLK 725



BLK 725P

4.5" stainless steel serrated blade sickle. 9.5" OAL  
**BAR BLK725** • 2.2 oz.  
**BAR BLK725P** • poly handle



BLK 727



BLK 727P

6.25" stainless steel serrated blade sickle. 13.5" OAL  
**BAR BLK727** • 3.1 oz.  
**BAR BLK727P** • poly handle



6.25" carbon steel serrated blade sickle. 13.5" OAL  
**BAR BLK730** • 3.1 oz.



4" carbon steel blade grass weeder. 12" OAL  
**BAR BLK733** • 4.3 oz.



6.25" carbon steel tiger tooth blade grass sickle. 14.75" OAL  
**BAR BLK735** • 5.3 oz.

**ORDER ON LINE at**  
[www.oescoinc.com](http://www.oescoinc.com)



**Garden Knife**

8" tempered high carbon spring steel blade. Orange poly handle for visibility.  
**BMI MM-8-O** • 4 oz.



**Zenport**  
INDUSTRIES



All knives have plastic handles and stainless steel blades.



**KC05 Fruit Sampling Knife**

4.75" folding blade designed for sampling of citrus, apples, melons, avocados and other fruit to check for ripeness.  
Comes with case.  
10.5 OAL  
**ZEN KC05**



Produce Knife, 6" blade.  
**ZEN K116** • 3 oz.



Lettuce Knife, 7.25" blade.  
**ZEN K115** • 4 oz.



Hop or Cabbage Knife, 6.75" blade.  
**ZEN K113** • 4 oz.



Garden Knife, 7.75" blade.  
**ZEN K118** • 4 oz.



Field Harvest Knife, 7.75" blade.  
**ZEN K114** • 4 oz.



Seed Potato Knife, 3.5" blade.  
**ZEN K123** • 4 oz.



Food Processing Knife, 2" blade.  
**ZEN K124** • 4 oz.



Mushroom Knife, 2.75" blade.  
**ZEN K125** • 4 oz.



Food Processing Knife, 3.5" blade.  
**ZEN K127** • 4 oz.





### HORI - HORI

Multipurpose knife. Dig, weed, transplant, divide perennials. Beveled for shoveling and a serrated side for sawing. Stainless steel blade, hardened in RC47-50. Fully polished. 6 3/4" long blade. Pointed tip, engraved depth measurements from 25-150mm. 5 1/8" wood handle. Includes sheath.  
**ARS KNK DA1S** • .5 lb.  
 Same as above but with carbon steel blade.  
**ARS KNK DA1** • .5 lb.



**ZenBori Soil Knife** - Similar to the Japanese Hori-Hori knife but with an ABS plastic handle. Stainless steel blade.  
**ZEN K245** • .5 lb.



**NEW**

This pouch is designed for carrying the K245 ZenBori Soil Knife. Durable nylon with belt loop.  
**ZEN HJ245**



### Digging Tool

The ultimate digging tool. Cuts through roots. Digs in any type of ground cover. Cuts turf, sod easily, trowel handle, 7" blade x 1 3/4"W, 12" OAL with 4" hand guard and 4" of teeth right side. Supplied with a sheath with 3"W X 3.5" deep belt loop.  
**WWM 48** • 9oz.

**MADE IN USA**  
 Wilcox Digging Tools are made of 12 & 16 gauge stainless steel blades with rubber handles. Depth gauges are etched into the blades.



Smooth Grip	Dimpled Grip	Finger Grip
		Smooth Grip
		Finger Grip
		Finger Grip
		Finger Grip
		Finger Grip
		Dimpled Grip
		Smooth Grip
		Finger Grip
		Finger Grip
		Finger Grip
		Finger Grip
		Finger Grip

DIGGING

**SHEARING KNIVES**



*Pictured with formed handles*

The #1 Shearing Knife In The Industry ... High Carbon Stainless Steel Blades

**STRAIGHT EDGE BLADES**

**SFP 40716** - 16" Straight Edge, 6" Beech Wood Handle

**SFP 40916-LHF** - 16" Straight Edge, 12" Formed Rosewood Handle

**SFP 40916-LHS** - 16" Straight Edge, 12" Straight Rosewood Handle

**SERRATED EDGE BLADES**

**SFP 40716-SC** - 16" Serrated Edge, 6" Beech Wood Handle

**SFP 40916-SCLHF** - 16" Serrated Edge, 12" Formed Rosewood Handle

**SFP 40916-SCLHS** - 16" Serrated Edge, 12" Straight Rosewood Handle

**SFP 40916-SCXLHF** - 16" Serrated Edge, 18" Formed Rosewood Handle

**SFP 40916-SCXLHS** - 16" Serrated Edge, 18" Straight Rosewood Handle

**Lamson®**

Knives have high carbon stainless steel blades and hardwood handles. Christmas tree and nursery shearing and shaping.



Straight blade

Serrated blade

**LAM 38322** - 16" straight blade, 5" handle • 8 oz.

**LAM 38352** - 16" straight blade, 10" handle • 9 oz.

**LAM 38329** - 16" serrated blade, 5" handle • 8 oz.

**LAM 38355** - 16" serrated blade, 10" handle • 9 oz.

**LAM 38555** - 16" serrated blade, 14" handle • 10 oz.

**Brush King®**



16" straight stainless blade with 18" hardwood handle. Made in Germany.

**BRU 83RB16/18** • 10 oz.

**NEW**



**SFP 40782** - 12" Oval diamond sharpening steel. Recommended for Sharp Shop serrated knives and any straight shearing knives.



**EZE P** - 10" Diamond sharpening steel. Recommended for Lamson serrated shearing knives and any straight shearing knives.

**NEW**

**HEAVY DUTY SHEARING CHAPS**

When shearing trees, The Sharp Shop Shearing Chap offers superior protection against injuries caused from shearing knives. Both models have an adjustable belt loop and 3 adjustable straps with nylon buckles for targeted protection.



3 layer - 2 layers of heavy duty duck material with inner layer of nylon mesh. White (pictured). **SFP 40899**

5 layer - 600 denier nylon. Black. **SFP 40900**



**SHEARING KNIFE SHEATH**

Leather stitched and riveted. Fits blades up to 1 1/2" x 18"

**WEA 08-97204**

BARNE USA



9" hard chrome blade, light-medium duty. Replaceable blades. Forged aluminum handles. 27 1/2" OAL

**BAR B1000L** • 2 lbs.

9" wavy blade, forged handles. 28" OAL

**BAR B1010L** • 2.2 lbs.



**NEW**



Classic curved anvil pruner with forged aluminum handles and counter blade. 8" OAL **CAS UNIVERSALE** • 7.2 oz.



**NEW**



New adjustable anvil, beveled blade, forged aluminum alloy handles **FEL F-31** • 7.9 oz.



Wreath Makers Favorite **ARS HP-300L** • 3.5 oz.



**BAH 331-21-51-KP** - 21" Bow Saw • 1.5 lbs.



**BAH 10-21-51** - 21" Bow Saw • 1.5 lbs.

**NEW COLD STEEL MACHETES & SHEATHS**

**Kukri Machete with sheath**



13" blade, 18" OAL  
CLD 97KMS • 16 oz.

Blades are 1055 carbon steel with tough spring temper and surfaced with a black, baked-on rust proof finish. The handles are polypropylene handles for a comfortable, secure grip. The sheaths are made of tough cordura nylon with taped and riveted seams.

**Bolo Machete order sheath separately**



16 3/8" blade, 22" OAL  
CLD 97BM • 17.3 oz.

Sheath only  
CLD SC97BM

**Latin Machete order sheath separately**



CLD 97AM18 - 18" blade, 23 5/8" OAL • 14.9 oz.  
CLD 97AM21 - 21" blade, 26 5/8" OAL • 17.7 oz.

Sheath only  
CLD SC97AM18  
CLD SC97AM21

**NEW COLD STEEL**

**Trail Boss**



Light and compact enough to carry all day in your hand or strapped to your pack, yet heavy and tough. Featuring a European style head with a 4" blade and a 4 1/2" cutting edge. The handle is straight-grained hickory. 23" OAL  
CLD 90TA • 2.6 lbs.

**NEW COLD STEEL**

**Trail Hawk**



Modeled after an early frontier pattern, The Trail Hawk is an excellent chopping tool with a functional hammer poll with hardened face. Lightweight and compact. 19" OAL  
CLD 90TH • 1.2 lbs.



**Camping/Outdoor Axe w/Belt Pouch**

Forged heavy-duty camping axe with hammer head, ABS handles and reinforced nylon belt pouch. 10 1/2" OAL  
BAR B1080 • 6.5 lbs.

**NEW**

**CORONA**

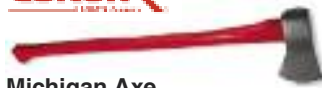

**Michigan Axe**

34" Solid core fiberglass handle. Tempered steel head.  
COR AX-70020 • 6.5 lbs.

**BAHCO**



**GENERAL PURPOSE AXE**

26" axe, for general applications - camping, gardening & occasional trimming & splitting. High quality tool, steel curved head, ash handle.  
BAH HUS-1.0-650 • 3 lbs.



**CLEARING AXE**

27" multi-purpose clearing axe, replaceable hickory handle.  
BAH 3022 • 2.2 lbs.  
BAH 3029 • Replaceable handle • 13 oz.  
BAH 3028 • Replaceable blade • 3.2 oz.

**CORONA**



Machete  
18" tempered carbon steel blade.  
Anti-slip handle.  
COR MA-60041 • 14 oz.

**SEYMOUR**



**MACHETE**

Cutlery steel machete with black poly handle, brass rivets.  
SEY 2PMA22 - 22" blade • 1 lb.  
SEY 2PMA24 - 24" blade • 1.25 lbs.

**CANVAS SHEATH FOR SEYMOUR MACHETE**

SEY 2PMA22S - 22" blade • .15 lbs.  
SEY 2PMA24S - 24" blade • .15 lbs.



High carbon spring tool blades, injection molded high impact handles. Made in USA.



**ECONOMY MODEL**

Poly handle, .070 thick steel blade.  
BMI E-18 - 18" • 1 lb.  
BMI E-22 - 22" • 1.25 lbs.  
BMI E-24 - 24" • 1.35 lbs.



**HEAVY DUTY MODEL**

Orange safety handle, .095 thick steel blade.  
BMI M-12-O - 12" blade • 1.25 lbs.  
BMI M-18-O - 18" blade • 1.5 lbs.  
BMI M-22-O - 22" blade • 1.65 lbs.  
BMI M-24-O - 24" blade • 1.75 lbs.

**CANVAS SHEATH FOR BMI MACHETE**

BMI CS16 - 16" • 3.2 oz.  
BMI CS18 - 18" • 3.2 oz.  
BMI CS22 - 22" • 3.2 oz.  
BMI CS24 - 24" • 3.2 oz.

**SEYMOUR**



Cane Knife  
Hardwood handle. 13" blade  
SEY 2P-CN13 • 1.2 lbs.



Corn Knives  
Hardwood handle.  
SEY 2C-33 - 1.38" x 18" blade (top) • 14 oz.  
SEY 2C-66 - 2.75" x 15" blade (center) • 17 oz.  
SEY 2C-99 - 3" x 18" blade (bottom) • 20 oz.

**Lamson®**



**NURSERY KNIFE**

High carbon stainless steel 1 5/8" x 8" or 12" stiff blade with 5" polypropylene handle.  
LAM 31420 - 8" • 8 oz.  
LAM 31460 - 12" • 9 oz.

**EARTHWAY PRECISION GARDEN SEEDER**

Aluminum frame, poly wheels. Includes 6 seed plates (corn, radishes, carrots, beans, peas, and beets), precision depth/gauge, row markers for even spacing. Options: Seed plate set, seed plate storage case, fertilizer applicator.  
**EAR 1001B** • 11 lbs.



**EarthWay**

**EARTHWAY KENTUCKY HIGH WHEEL CULTIVATOR**

Wood frame, 24" steel wheel. Includes 3 standard tools: 5-tine cultivator, moldboard plow, twin end furrow plow. Optional slicing hoe.  
**EAR 60132** • 19 lbs.



Order Online



**GT NEJIRI KAMA**

The perfect weeding tool!

High carbon steel blade, wooden handle. 12" OAL

**ARS KNK-MT211** • 8 oz.



**Cobrahead Weeder/Cultivator**

Weeds, cultivates, scalps, edges, digs, furrows, plants, dethatches, and harvests with ease. Made in the USA of knife-blade quality self-sharpening steel. Environmentally friendly wood fiber reinforced recycled plastic handle. VERY POPULAR.

**COB Cobrahead** • .5 lb.



**Maine Garden Hod**

Use for produce, tools, etc.

Large: 19 1/4" L x 11" W x 7 1/4" H, handle is 11" high with 9" clearance, 16 qt. capacity.

**MGP W/024-063/HP** • 3.5 lbs.

Li'l Hod: 16" L x 9" W x 5 1/4" H, handle is 9 1/2" high with 8" clearance, 8 qt. capacity.

**MGP WLH/006-024/HP** • 2 lbs



**Landscaping with Fruit**

Lee Reich shows you exactly how to grow temperate-zone fruit at home, from site analysis and climate assessment through plant selection, pest control, pruning, and harvesting. Strawberry groundcovers, blueberry hedges, grape arbors, and 39 other luscious fruits to make your yard an edible paradise. *By Lee Reich*  
**BOK 62091**

NEW

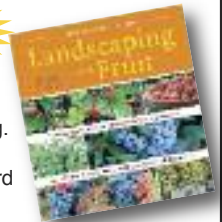

**B6000 TROWEL**

12" Ergonomic transplanter. Aluminum, cushioned grip.

**BAR B6000** • 8 oz.



**B6300 TRANSPLANTER**

12" Ergonomic transplanter. Aluminum, cushioned grip.

**BAR B6300** • 8.3 oz.



**B6002 CULTIVATOR**

11.5" Ergonomic trowel. Aluminum, cushioned grip.

**BAR B6002** • 9.2 oz.



**P244 CULTIVATOR**

13 1/2" long, black epoxy coated tines with wood handle.

**BAH P244** • 7 oz.



**P243 TROWEL**

13" long, black epoxy coated blade, wood handle.

**BAH P243** • 12 oz.



**P247 HOE-TWO POINT**

13" long. Good for cultivating flower beds. Black epoxy coated steel w/wood handle.

**BAH P247** • 8.3 oz.



**P241 BULB PLANTER**

9" long, black epoxy coated steel blade, wood handle.

**BAH P241** • 10.5 oz.



**BP-S BULB PLANTER**

9" Adjustable bulb planter. Measurement indicator.

**BAR BP-S** • 11.6 oz.

**Leather Tool Belt/Bag**

20" x 9" Double riveted. Includes pouch for pruners, loop for loppers and pocket for accessories. Adjustable quick release belt.

**BAR BTC-2** • 14.5 oz.



NEW

**Garden Rocker**

Reduces knee and back strain. Rocking motion makes sitting or kneeling more comfortable. More than a garden seat - auto, hobby or work seat. Recommended weight capacity: 350 lbs.

**VER GB1200C**



VER GB1200C

**Rocker Cushion**

Padded cushion with tool pockets.

**VER GB1210C**



**SUMIO WIRE BROOM**



Special design, plastic handle. 6 teeth, 4 adjustable widths. Light and handy in the garden.

**ORC KC-637** • 2.5 oz.

# SEYMOUR

## WEED CUTTER

Weed cutter with serrated edges and formed steel brackets.  
Head: 14" x 2.5".  
30" hardwood handle.  
**SEY WE20** • 3 lbs.

## GRASS HOOKS

American pattern 5" wood handle, steel ferrules.  
12" curved blade.  
**SEY 2G-25** • 3/4 lb.

Same pattern 44" long hardwood handle with steel ferrule. 12" curved blade.  
**SEY 2G25LH** • 2 lbs.

## SNATHS

White ash handle designed for grass, weeds, light brush.  
**SEY SN-1** • 4 lbs.

Aluminum handle designed for grass, weeds, light brush.  
**SEY SN-9** • 4 lbs.

Require blades below

Blades made in Austria

## GRASS SCYTHE BLADES

30" blade for grass  
**SEY 2B42G30** • 2.2 lbs.  
28" blade for grass  
**SEY 2B42G28** • 2 lbs.

## BRUSH SCYTHE BLADE

20" long wide blade for brush  
**SEY 2B42B20** • 2 lbs.

## WEED SCYTHE BLADE

24" long blade for heavy weeds  
**SEY 2B42W24** • 2 lbs.

**WE CARRY PARTS FOR ALL THE TOOLS WE SELL. CONTACT US BY PHONE, FAX OR EMAIL FOR MORE INFORMATION.**



Order Online



## Spring Bucket

Collapsible nylon spring bucket with adjustable padded shoulder strap. It's especially helpful when working around a garden or trimming bushes. 2 sizes available.

Collapsing vinyl buckets.  
**BAR B900** - 22"D x 26"H, 43 gallon capacity  
**BAR B902** - 11.75"D x 14.5"H, 7 gallon capacity

## HELPING HANDS SWEEP

Lightweight.  
14" wide. Pair.  
**BAR B920**



## LAWN SHEARS

44" long. Cuts under shrubs, borders around trees. 36" steel tube handles. 8" steel blades horizontally oriented.  
**BAH P74** • 4.5 lbs.

## EDGING SHEARS

39" long. For trimming borders or sod. 36" steel tube handles, 8" steel blades, vertically oriented.  
**BAH P75** • 4.5 lbs.

## GRASS SHEARS

6" stainless steel blades, 180° rotating blades.  
**BAH GS-180-E** • 13 oz.



3 position, 90° handle rotation, grass shear. 13" long.  
**BAR B5050** • 13.1 oz.



Longer blade. 2 1/2" blade, 8" overall. For grass, leaves, onions, etc.  
**ARS HP-SE65** • 5.4 oz.

## PROFESSIONAL GRASS SHEARS



5" forged steel alloy blade. 12" OAL  
**COR GS-6750** • 1 lb.

## HARVEST SHEARS



Teflon coated blades, cushioned grip, stainless handles complete with leather sheath. 12" long.  
**BAR B3333** - 5" blade, 11 3/4" OAL • 11.3 oz.  
**BAR B3344** - 6 1/2" blade, 13" OAL • 12 oz.

GRASS CUTTING



OUR BEST SELLING HEDGE SHEARS

Extremely strong, very light aluminum handles in two lengths. Double locking center bolt system. Fully hardened 10" blades, lower end has serrations for 1/2" cutting capacity in greenwood.



**BAH P51-SL** - 23" OAL • 2.35 lbs. • **BAH P51H-SL** - 30" OAL • 2.7 lbs.

WOOD HANDLES



Wood handles, 10" straight HC steel blade, 21" OAL, 3/8" capacity in greenwood.  
**BAH P57-25-F** • 2.2 lbs.

**P54** Super light hedge and grass shears. Light duty. Shearing action. Narrow blades.



Short handles, 10" blades  
**BAH P54-SL-25** - 22" OAL • 1.8 lbs.



Wood handles, 10" wavy edge HC steel blade, 21" OAL, 3/8" capacity in greenwood.  
**BAH P57-25W-F** • 2.2 lbs.

Long handles, 8" blades  
**BAH P54H-SL-20** - 24" OAL • 1.8 lbs.

Long handles, 10" blades  
**BAH P54H-SL-25** - 26" OAL • 1.85 lbs.



Order online!  
[www.oescoinc.com](http://www.oescoinc.com)



25.5" overall. Orange handle. Hard chrome, 8" replaceable blade  
**ARS HS-K1000L** • 1.6 lbs.



30" overall. Hard chrome, 8" replaceable blade  
**ARS HS-K1100** • 1.65 lbs.



20" overall. Narrow, thin, 7" non-replaceable nickel-plated blade.  
**ARS HS-K800R** • 1.4 lbs.



9" hard chrome blade, light-medium duty. Replaceable blades. Forged aluminum handles. 27 1/2" OAL  
**BAR B1000L** • 2 lbs.



9" wavy blade, forged handles. 28" OAL  
**BAR B1010L** • 2.2 lbs.



ULTIMATE HEDGE SHEARS

Lightweight and very sharp, high quality cutlery steel blades, drop forged and heat treated. Oak handles. 3 models available.

Finish hedge trimmer. 9" blade, 26" OAL  
**ARS HSK-N352** • 2 lbs.

Heavy blade, 1/2" capacity. 9" blade, 23" OAL  
**ARS HSK-372** • 2.15 lbs.

Heavy blade, 1/2" capacity. 9" blade, 28.5" OAL  
**ARS HSK-375** • 2.15 lbs.

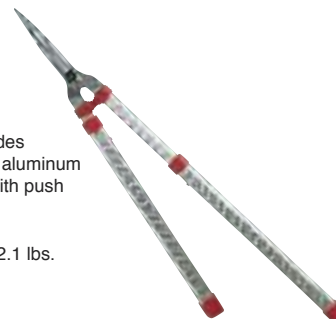

TELESCOPING SHEARS

6" nickel plated thin blades mounted to telescoping aluminum tube handles. Adjusts with push button to 3 positions. 29-41.5" OAL.

**ARS HS-K900Z** • 2.1 lbs.



12.5" steel alloy blade. **HEAVY DUTY** with extruded aluminum handles. 30" OAL  
**BAR B1100L** • 3.2 lbs.



True Friend/Freunde Hedge Shears

Manufactured in Germany. Hard Chromed and Hollow Ground Blades.

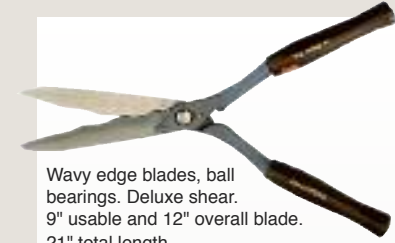

Wavy edge blades, ball bearings. Deluxe shear. 9" usable and 12" overall blade. 21" total length.  
**TRU 512** • 2.25 lbs.



Straight blades, pruning notch, adjustable blade locking thumb nut. 9" usable, 12" overall blade. 22.5" total length.  
**TRU 612** • 2.75 lbs.



Straight oversized blade, pruning notch, longest blade, adjustable blade thumb nut. 11" usable, 14" overall blade. 26" total length.  
**TRU 614** • 3 lbs.

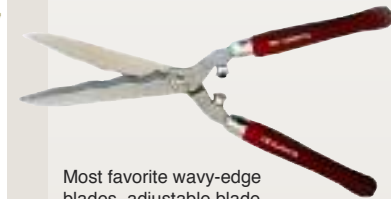

Most favorite wavy-edge blades, adjustable blade thumb nut. 9" usable, 12" overall blade. 22" total length.  
**TRU 1954** • 2.88 lbs.



Wavy edge blade, adjustable blade thumb nut. 9" usable, 12" overall blade. 23" total length.  
**TRU 1962** • 3 lbs.

# Innovative anvil style loppers are the latest trend in European orchard pruning!

**NEW**



Manufacturer of high quality horticultural tools for over 30 years

- Forged steel blade tempered to the highest level for optimum cutting performance & durability
- Forged aluminum alloy anvil designed to reduce cutting blade wear and provide strength
- Sturdy and lightweight tubular aluminum handles

The lightness of the lopper head is particularly apparent when making long reaching cuts. Features a unique straight blade and anvil design. Very clean cutting.

**CAS M80** - 32" OAL, 1.7" capacity • 2.3 lbs.

An excellent entry level lopper for home horticulture use. The curved anvil and blade improves the cutting ability. This tool has an excellent power to weight ratio.

**CAS TRONCARAMI-80** - 32" OAL, 1.5" capacity • 1.75 lbs.



Unique anvil cushioning system reduces cutting impact

Beveled blade on both sides for easier penetration into the wood

Lightweight design, strength and reduced cutting effort result in less arm and shoulder strain



F230

F231

**NEW**



- Sturdy and lightweight tubular aluminum handles
- Innovative lever system that greatly reduces the required cutting effort
- Large opening of the cutting head easily allows the cutting of branches up to 1.6"
- Two models to choose from based on the shape of their cutting heads



Features a straight, tapered anvil that allows easy access to the location of the cut.

**FEL F230** - 32" OAL, 1.6" capacity • 2.5 lbs.



Features a hollow shaped blade and a curved anvil that traps the branch close to the fulcrum of the cutting head, thus making cutting wood easier.

**FEL F231** - 32" OAL, 1.6" capacity • 2.5 lbs.



Strong, lightweight aluminum handles. Heavy duty anvil lopper head. Anti-friction coating on the blade facilitates penetration through the wood. Lever action sliding system makes the cutting easier. 50% power gain.

**BAH P172-SL-85** - 32" OAL, 1 1/2" capacity • 2.8 lbs.

**NEW**



**NEW****FELCO**  
SWISS MADE**Strong & Light Loppers!**

Interchangeable aluminum tubes.



16" OAL  
1 1/2" cutting capacity  
1.4 lbs.  
**FEL F-200-A-40**

20" OAL  
1 1/2" cutting capacity  
1.6 lbs.  
**FEL F-200-A-50**  
**FEL F-210-A-50**

24" OAL  
1 1/2" cutting capacity  
1.75 lbs.  
**FEL F-200A-60**  
**FEL F-210A-60**

Straight or curved cutting head available for all bypass loppers

**A Heavy Duty Classic Favorite!**

The Felco F-22 has solid, forged aluminum handles. Straight cutting head. 33" OAL, 2" cutting capacity.



**FEL F-22** • 4.5 lbs.

**CORONA**  
AN IRVING-CLOUD COMPANY

OAL = Over All Length - All parts available.  
Blades are High Carbon Steel

**ORCHARD LOPPERS**

**COR AL-8481** - 36" OAL, metal handle • 3.5 lbs.  
**COR AL-8461** - 32" OAL, metal handle • 3.3 lbs.  
**COR AL-8441** - 26" OAL, metal handle • 3 lbs.

**VINE LOPPER**

**COR AL-8320** - 19" OAL, metal handle • 1.8 lbs.

**PRO LOPPERS - ALUMINUM HANDLES**

**COR AL-8260** - 32" OAL, 2" cap. • 3 lbs.  
**COR AL-8240** - 26" OAL, 2" cap. • 2.6 lbs.

**FRUIT GROWER LOPPER**

High torque lopper. 2" capacity, 26" long. Resharpenable forged steel blade. Aluminum handle.

**COR AL-6511** - 26" OAL • 2.33 lbs.

**HEAVY DUTY WOOD HANDLES**

**COR WL-6481** - 36" OAL, 2" cap. • 3.3 lbs.  
**COR WL-6461** - 32" OAL, 2" cap. • 3 lbs.  
**COR WL-6431** - 26" OAL, 2" cap. • 2.6 lbs.

**SUPER DUTY WOOD HANDLES**

**COR WL-6490**  
37" OAL, 3" cap., wood handle • 6.5 lb.

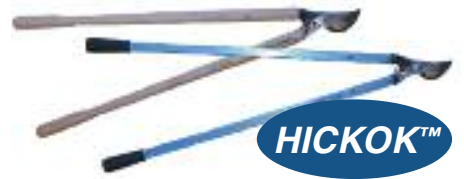
**HICKOK™**

Quality loppers with wood or aluminum handles and a strong alloy steel blade. 2 blade sizes: Vine - medium duty and Tree - heavy duty

**Vine Loppers****Aluminum Handles**

**HIC 20M** - 20" OAL • 1.94 lbs.

**HIC 24M** - 24" OAL • 2.12 lbs.

**Hickory Handles**

**HIC 20V** - 20" OAL • 1.46 lbs.

**HIC 24V** - 24" OAL • 1.72 lbs.

**Tree Loppers****Aluminum Handles**

**HIC 32A** - 32" OAL • 2.86 lbs.

**HIC 36A** - 36" OAL • 3.04 lbs.

**Hickory Handles**

**HIC 32W** - 32" OAL • 2.86 lbs.

**HIC 36W** - 36" OAL • 2.76 lbs.

**Order Online****VACA CLASSIC FRUIT TREE SHEAR**

Fruit grower specialty high quality loppers.  
Made in U.S.A. for 90 years.  
2" capacity green wood.



**VAC 5921H** - 27" OAL, hickory handles • 2.75 lbs.

**VAC 5926H** - 32" OAL, hickory handles • 3 lbs.

**VAC 5921A** - 27" OAL, aluminum handles • 2.5 lbs.

**VAC 5926A** - 32" OAL, aluminum handles • 2.75 lbs.

**PORTER FERGUSON****VERY HEAVY DUTY BRUSH CUTTERS**

Both blades cut. Heat treated alloy steel. Heat treated spring steel handles with rubber handles. 0290F has power shift center.

**PTF 0290F** - 27" OAL, 1 1/2" cap. • 4.7 lbs.

**PTF 0290P** - 24" OAL, 1 1/4" cap. • 3 lbs.

Pointcut head, cut with tip of blade (not pictured)

**Ratchet Lopper**

25 3/4" - 37 3/4" adjustable telescoping extruded aluminum handles, high carbon steel blade, ratchet lopper.

**RAR RR2000** - 2" capacity • 2.6 lbs.



Made in the U.S.A., strong forged steel blade, deep hook, sap groove, poly bumper and oiler bolt. Available with aluminum or hickory handles in 2 capacities - Tree and Orchard.

### LANDSCAPE TREE LOPPERS

Deep hook, heavy duty blades

Extruded

Aluminum Handles - 2 1/4" cap.

- BAR B26A - 26" OAL • 2.67 lbs.
- BAR B28A - 28" OAL • 2.7 lbs.
- BAR B30A - 30" OAL • 2.8 lbs.
- BAR B32A - 32" OAL • 2.9 lbs.
- BAR B36A - 36" OAL • 3.1 lbs.



Aluminum handles with grip

Wood Handles - 2 1/4" cap.

- BAR B26W - 26" OAL • 2.25 lbs.
- BAR B28W - 28" OAL • 2.5 lbs.
- BAR B30W - 30" OAL • 2.6 lbs.
- BAR B32W - 32" OAL • 2.8 lbs.
- BAR B36W - 36" OAL • 3.0 lbs.

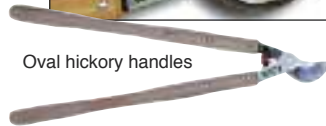

Oval hickory handles

### ORCHARD LOPPERS

Medium hook, well balanced. Lighter weight

Extruded

Aluminum Handles - 1 3/4" cap.

- BAR OR26A - 26" OAL • 2.3 lbs.
- BAR OR28A - 28" OAL • 2.4 lbs.
- BAR OR30A - 30" OAL • 2.5 lbs.
- BAR OR32A - 32" OAL • 2.6 lbs.
- BAR OR36A - 36" OAL • 2.8 lbs.



Aluminum handles with grip

Wood Handles - 1 3/4" cap.

- BAR OR26W - 26" OAL • 2 lbs.
- BAR OR28W - 28" OAL • 2.2 lbs.
- BAR OR30W - 30" OAL • 2.3 lbs.
- BAR OR32W - 32" OAL • 2.4 lbs.
- BAR OR36W - 36" OAL • 2.5 lbs.

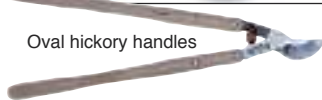

Oval hickory handles

### HORTICULTURAL LOPPERS

Small hook, light capacity

Extruded

Aluminum Handles - 1 1/2" cap.

- BAR H20A - 20" OAL • 2 lbs.
- BAR H24A - 24" OAL • 2.2 lbs.
- BAR H26A - 26" OAL • 2.3 lbs.
- BAR H30A - 30" OAL • 2.5 lbs.



Aluminum handles with grip

### MINI VINE LOPPER

Straight cutting head, ultra light. Extruded aluminum handles. 1 1/4" capacity.

- BAR M16A - 16" OAL • 1.8 lbs.



### LANDSCAPE/TREE LOPPERS



NEW

- BAH P19-80F - 32" OAL • 4.44 lbs.

Heavy duty bypass lopper for cutting very thick large branches on mature trees. 2" capacity.



NEW

- BAH P280-SL-80 - 32" OAL • 3 lbs.

Heavy duty lopper for thick greenwood. 1 1/2" capacity. Lever action slicing system makes cutting easier.

NEW

### ORCHARD/TREE LOPPERS

Specially designed for orchards and recommended for landscaping.



- BAH P160-SL-60 - 24" OAL • 2.4 lbs.
- BAH P160-SL-75 - 30" OAL • 3.1 lbs.
- BAH P160-SL-90 - 35" OAL • 3.7 lbs.

Slim, narrow blade combined with hooked counter blade results in powerful and smooth cutting action. Long handles for easy reach and overhead cutting. 1 3/4" capacity.

### VINE LOPPERS



NEW

- BAH P116-SL-40 - 16" OAL • 1.6 lbs.
- BAH P116-SL-50 - 20" OAL • 1.8 lbs.
- BAH P116-SL-60 - 24" OAL • 1.9 lbs.
- BAH P116-SL-70 - 27" OAL • 2 lbs.

### P116 SERIES

Extremely strong, very light aluminum handles result in less fatigue. Two edged radii blade with evolving bevel for better durability and easier cuts on tough wood. 1 1/4" capacity.



NEW

- BAH P114-SL-50 - 20" OAL • 1.5 lbs.

### P114 SERIES

Narrow cutting head for easy access and precise, quick cuts. Extremely strong, very light aluminum handles result in less fatigue. 1 1/4" capacity.



NEW

- BAH P114-SL-60 - 24" OAL • 1.8 lbs.

Order Online

LOPPERS

**BARNEL Ultra Reach® Pruners & Loppers**

<b>BAR B88T</b>	Telescoping lopper, 1 1/2" capacity, bypass blade, 6'-8' long	77.6 oz.
<b>BAR B188Z6-10</b>	5'11"-9'11" telescoping handle, 5/8" capacity, bypass pruning head w/hold feature	39 oz.
<b>BAR B188Z4-6</b>	49"-79" telescoping handle, 5/8" capacity, bypass pruning head w/hold feature	30.7 oz.



Spring adjustable hold feature for B188 blade



Head for B88T lopper



**Long Reach Cut 'n Hold Pruner**

Ideal for pruning deep bushes, small branches, vines and shrubs. Cuts up to 1/2" diameter. 46" OAL • 1.3 lbs.

**COR LR-3460**



**Powerful LongReach™ Pruner**

**Our Most Popular Long Reach Lopper!**

- Lightweight aluminum arm is easy to handle
- Blades are sharp & durable
- Hard chrome plating on blades, resists rust and corrosion
- Convertible arm section allows you to turn the pruner blades in any direction without moving the hand grip
- Bigger, angled blade with thicker arm provides extra strength

<b>ARS LA-180L12</b>	48" OAL	23.8 oz.
<b>ARS LA-180L18</b>	72" OAL	28.6 oz.
<b>ARS LA-180L21</b>	84" OAL	31.5 oz.

**Order Online**



**Largest Cutting Capacity ... 3/4"**

**LongReach™ Lopper**

- Clean cuts prevent injury or disease of the tree limbs
- Easily dismantled for maintenance
- Lever mechanism makes it easier to cut thick tree limbs
- Easily rotate the head 180° to reach the branches you want to cut
- Rubber bumper reduces fatigue from many pruning jobs

60" OAL • 3.75 lbs.  
**ARS LP-18515**

72" OAL • 4 lbs.  
**ARS LP-18518**



Blade set for LA180 Series pruners  
**ARS SP-180L-1**



Blade set for LongReach™ lopper  
**ARS SP-185-1**





## R Series

### FIXED LENGTH LONGREACH™ PRUNERS

Super light and easy to use! These fixed length pruners feature Marquench hardened chrome plated blades. The arm rotates to angle the blade where it needs to go, keeping the handle comfortably in place. Perfect for all day use! The LA-160R series with the rust-proof zinc rod is very popular for water gardening. *R Series Cut & Hold and Razor edge heads are interchangeable.*



Product	Head	OAL	CAP	Weight	Blades
LA-160R036	Cut & Hold	1'	1/4"	.66 lbs	Marquench
LA-160R06	Cut & Hold	2'	1/4"	.8 lbs	Marquench
LA-160R12	Cut & Hold	4'	1/4"	1.0 lbs	Marquench
LA-160R18	Cut & Hold	6'	1/4"	1.4 lbs	Marquench
LA-160R12	Razor Edge	4'	1/2"	1.1 lbs	Marquench
LA-160R18	Razor Edge	6'	1/2"	1.4 lbs	Marquench

### Rose Pruner • LA-15006

This pruner features specialized cut and hold blades for dead-heading, picking roses, and cleaning rose beds. HC tool steel blade, hard chrome plated blade finish, PVC handles. 2' OAL.



ARS LA-15006 • 11 oz.



## ZR Series

### TELESCOPING & FIXED LENGTH LONGREACH™ PRUNERS

#### Swing Neck

New aluminum die-cast tilt neck allows the head to tilt +/- 30°. Dial nut securely locks desired angle into place.

#### Telescoping Models

Adjusts from either 4 to 7 feet in 3 stops or 6 to 10 feet in 5 stops.



Awarded the National Home Garden Club Seal-of-Approval



#### Drop Forged Blades

Slim design drop forged blades have greater durability and cutting leverage. Hard chrome plating for sap and rust resistance.

#### Single Operation Lever

The single pin enables simple telescoping operation.

#### Ergonomically Designed Grip

Light and strong aluminum die-cast grip with non-slip plastic coating for comfort and ease of handling.



Product	Head	OAL	CAP	Weight	Stops	Blades
LA-160ZR203	Cut & Hold	4'-7'	1/4"	2.3 lbs	3	Drop Forged
LA-160ZR306	Cut & Hold	6'-10'	1/4"	2.9 lbs	5	Drop Forged
LA-180ZR203	Razor Edge	4'-7'	1/2"	2.3 lbs	3	Drop Forged
LA-180ZR306	Razor Edge	6'-10'	1/2"	2.9 lbs	5	Drop Forged
LA-190ZR315	Super Trimmer	6'-10'	1/4"	2.9 lbs	5	Marquench
LA-190ZR18	Super Trimmer	6'	1/4"	1.6 lbs	Fixed Length	Marquench

### AVAILABLE WITH 3 INTERCHANGEABLE HEAD OPTIONS



180 Razor Edge



160 Cut & Hold



190 Super Trimmer

# OESCO's Own Orchard Wheeler Pruning Saw



Recommended by growers and landscapers as a strong push cut saw.

- Thousands sold
- Milled plywood handle
- 16" blade
- Spring steel frame to remove blade
- Easy to use with gloves

ORC 16 - Wheeler saw • .75 lb.  
ORC 16S - Replacement blade for ORC 16



COR QS-7900  
Cuts 20% faster on average than comparable professional saws!

Repair parts and spare blades available. Contact us if you can't find what you are looking for ... we're here to help!



COR RS-7370



COR RS-7395



COR RS-7120



COR RS-7130

COR 7100-1 - Replacement blades for COR RS-7120 and COR RS-7130



COR RS-7160

	COR QS-7900	Curved 13" QuickSaw tapered blade w/hook. Textured elastomer grip	.7 lb.
	COR RS-7370	Straight 12" Razor Tooth blade co-molded handle	.7 lb.
	COR RS-7395	Curved 14" Razor Tooth blade co-molded handle	1 lb.
	COR RS-7120	Curved 13" Razor Tooth blade pistol grip cushioned handle	.5 lb.
	COR RS-7130	Curved 13" Razor Tooth blade wood pistol grip handle	.75 lb.
	COR RS-7160	Curved 21" Razor Tooth blade raker tooth, gullets wood "D" handle	1.5 lbs.



FAN FI-1311



FAN FS4



FAN FS14



FAN FS20

	FAN FI-1311	Curved 13" Tri edge blade laminated wood handle	.6 lb.
	FAN FS14	Curved 13" blade good in fruit and hardwood, 8" wood handle	.6 lb.
	FAN FS4	Same as FS14 but has 11" handle	.6 lb.
	FAN FS20	Curved 19" blade, 5 TPI, "D" wood handle	1.25 lbs.



FEL F611

Straight 12.5" blade, with sheath, 20" OAL, pistol grip handle • 12.5 oz.



FEL F621

Straight 9.5" blade, with sheath, 16.5" OAL, pistol grip handle • 11.5 oz.



BAH 5124JSH  
BAH 5128JSH  
BAH 5124JS  
BAH 5128JS

BAH 331-21-51-KP

BAH 10-21-51  
BAH 10-24-23

Blades for BAHCO 21" & 24" Bow Saws



Use BAH 51-21 (Standard) for green & dry wood - 21"  
BAH 51-24 (Standard) for green & dry wood - 24"



Use BAH 23-21 (Raker) for green wood - 21"  
BAH 23-24 (Raker) for green wood - 24"

	BAH 5124JSH	Straight 9.5" blade, hardpoint, fastcut, straight teeth w/holster	9.1 oz.
	BAH 5128JSH	Straight 11" blade, hardpoint, fastcut, straight teeth w/holster	9.6 oz.
	BAH 5124JS	Same as 5124JSH without holster	7 oz.
	BAH 5128JS	Same as 5128JSH without holster	7.5 oz.
	BAH 331-21-51-KP	Straight 21" bow saw, taper frame with #51 blade, finger guard	1.5 lbs.
	BAH 10-21-51	Straight 21" bow saw, #51 blade, finger guard	1.5 lbs.
	BAH 10-24-23	Straight 24" bow saw, #23 blade, finger guard	1.6 lbs.

### Blade Cleaner

Easily removes sap and dirt with just a spray and a wipe.

ARS GO1 - 3.8 fluid oz.





SIL 108-24 • PROSENTEI  
SIL 109-24 - replacement blade



SIL 102-30 • GOMTARO  
SIL 103-30 - replacement blade  
SIL 104-30 • GOMTARO  
SIL 105-30 - replacement blade



SIL 275-39 • IBUKI  
SIL 276-39 - replacement blade



SIL 270-33 • ZUBAT  
SIL 271-33 - replacement blade



Order #	Name	Blade	Teeth/inch	Length	Comments	Weight
SIL 108-24	PROSENTEI	straight	8/14	8.6"	2 sized teeth	.2 lb.
SIL 102-30	GOMTARO	straight	8	11.8"	impulse hardened	.8 lb.
SIL 104-30	GOMTARO	straight	13	11.8"	impulse hardened	.8 lb.
SIL 270-33	ZUBAT	curved	7.5	13.0"	impulse hardened	1 lb.
SIL 390-36	SUGOI	curved	6.5	14.2"	sharpenable	1.6 lbs.
SIL 275-39	IBUKI	curved	6.5	15.4"	sharpenable	1.6 lbs.



SIL 390-36 • SUGOI  
SIL 391-36 - replacement blade



Supplied with sheaths



BAR Z203



BAR Z301



BAR Z25



BAR Z17  
BAR Z17-1- replacement blade



BAR Z14  
BAR Z14-1- replacement blade



BAR Z13  
BAR Z13-1- replacement blade

Non-folding saws supplied with sheaths			
BAR Z203	9.5"	4.0mm tooth pitch, straight blade, co-molded handle	12 oz.
BAR Z301	11.75"	4.0mm tooth pitch, straight blade, co-molded handle	14 oz.
Large non-folding saws • Sheaths available			
BAR Z13	12.5"	4.0mm tooth pitch, curved blade, co-molded handle	.5 lb.
BAR Z14	14"	4.0mm tooth pitch, curved raker blade, co-molded handle	.5 lb.
BAR Z17	14.25"	4.0mm tooth pitch, curved blade, co-molded D-handle	.8 lb.
BAR Z25	17.25"	6.0mm tooth pitch, straight raker blade	1 lb.

ARS Saws don't rip like a saw, they cut like a knife!



made in Japan

Pro Series  
Pro Blade - highest quality Japanese steel



ARS SA-CT32PRO (pictured)  
ARS SA-UV32PRO (not pictured)  
Same as ARS SA-CT32PRO but with raker teeth

CAM Series



ARS SA-CAM24PRO



NEW

Signature Series

- Impulse hardened teeth
- Hard chrome plated blade
- Rubber coated grip
- Includes reversible scabbard
- Scabbard includes belt clip and patented roller technology

ARS SA-CT32E - 13" Curved blade, 19" OAL (with sheath) • .9 lb.  
ARS SB-CT32E1 - Replacement blade

ARS SA-CT32E	13" Curved Blade. 19" OAL (with sheath)	.9 lb.
ARS SA-CT32PRO	13" Curved Blade. 19" OAL (with sheath)	.9 lb.
ARS SA-UV32PRO	13" Curved Blade with Raker Teeth. 19" OAL (with sheath)	.9 lb.
ARS SA-CAM24PRO	10" Straight Blade. 17" OAL (with sheath)	.6 lb.



**BAR Z130**  
**BAR Z130C**  
**BAR Z130-1** - replacement blade



**BAR Z210**  
**BAR Z210-1** - replacement blade



**BAR Z180**  
**BAR Z180-1** - replacement blade



**BAR Z240**  
**BAR Z240-1** - replacement blade



**BAR Z270**  
**BAR Z270-1** - replacement blade

 All Barnel folding saws lock open & closed	<b>BAR Z130</b>	5.25" 3.0mm tooth pitch, straight blade, pocket saw	.4 lb.
	<b>BAR Z130C</b>	Pocket saw and clear designer case, belt clip	.6 lb.
	<b>BAR Z210</b>	6" 4.0mm tooth pitch, straight blade	.39 lb.
	<b>BAR Z180</b>	7" 4.0mm tooth pitch, curved blade	.5 lb.
	<b>BAR Z240</b>	9.5" 4.0mm tooth pitch, curved blade	.72 lb.
	<b>BAR Z270</b>	10.5" 4.0mm tooth pitch, curved blade	.75 lb.

	<b>ARS SA-GR17</b>	Curved 7" blade, folding & locking, co molded handle	.45 lb.
	<b>ARS SB-GR171</b>	Replacement blade for SA-GR17	
	<b>ARS SA-G18L</b>	Straight 7" blade, folding & locking, co molded handle	.45 lb.
	<b>ARS SB-P18L1</b>	Replacement blade for SA-G18L	



**ARS SA-GR17**

**ARS SA-G18L**

	<b>FEL F600</b>	Straight 6" blade, folding, locks open only, 14" OAL	4.8 oz.
	<b>FEL 600-3</b>	Replacement blade for F600	



**FEL F600**

**FEL 600-3**

	<b>COR RS-7041</b>	Straight 7" Razor tooth blade, folding and locking	.5 lb.
	<b>COR RS-7245</b>	Curved 7" Razor tooth blade, folding and locking	.4 lb.
	<b>COR RS-7255</b>	Curved 8" Razor tooth blade, folding and locking	.7 lb.



**NEW**

**Nylon Scabbard**

Universal design fits hand pruners and folding saws.

Easy to carry using metal clip or belt loop. Front pocket for sharpening stone.  
**COR AC-4510**



**COR RS-7245**  
**COR 7245-1** - Replacement blade



**COR RS-7255**  
**COR 7255-1** - Replacement blade



**COR RS-7041**  
**COR AC-7041** - Replacement blade

 Precision ground, razor sharp teeth w/4 cutting angles  SK-4 high carbon steel, taper ground, impulse hardened	<b>SIL 342-13</b>	<b>POCKETBOY</b> w/carrying case	5" fine toothed blade, 16.9 teeth/inch	.5 lb.	
	<b>SIL 340-13</b>		5" medium toothed blade, 8.47 teeth/inch	.5 lb.	
	<b>SIL 346-13</b>		5" large toothed blade, 6.77 teeth/inch	.5 lb.	
	<b>SIL 340-17</b>		6.7" medium toothed blade, 8.47 teeth/inch	.5 lb.	
	<b>SIL 346-17</b>		6.7" large toothed blade, 6.77 teeth/inch	.5 lb.	
	<b>SIL 143-18</b>	<b>F-180</b>	7" large toothed blade, 6.77 teeth/inch	.66 lb.	
	<b>SIL 119-21</b>		<b>SUPER ACCEL</b>	8.3" large toothed blade, 6.77 teeth/inch	.66 lb.
	<b>SIL 290-24</b>	<b>GOMBOY</b> w/carrying case		9.45" fine toothed blade, 11.85 teeth/inch	.66 lb.
	<b>SIL 121-24</b>			9.45" medium toothed blade, 10 teeth/inch	.66 lb.

**POCKETBOY**



Replacement blade

**SIL 342-13** (pictured) **SIL 343-13**  
**SIL 340-13** **SIL 341-13**  
**SIL 346-13** **SIL 347-13**



**F-180**

Replacement blade

**NEW**

**SIL 340-17** **SIL 341-17**  
**SIL 346-17** (pictured) **SIL 347-17**

All Pocketboy models include case



**SIL 143-18**  
**SIL 144-18** - Replacement blade

**SUPER ACCEL**



**SIL 119-21**  
**SIL 120-21** - Replacement blade

**GOMBOY**



**SIL 290-24** **SIL 121-24** (not pictured)  
**SIL 291-24** - Replacement blade **SIL 122-24** - Replacement blade



**Pole Saws - Ultra sharp, professional, lightweight poles**

**Excellent choice for landscape and fruit pruning**

Part#	Name	OAL	Extension Sections	Teeth/Inch	Blade Length	WT.
SIL 371-42	HAYATE 420	8' - 16'	3	6.5	16.5"	6.8 lbs.
SIL 372-42	HAYATE 420	8' - 20'	3	6.5	16.5"	8.7 lbs.
SIL 178-39	HAYAUCHI	7'8"-16'	2	5.5	16"	4.9 lbs.
SIL 179-39	HAYAUCHI	7'8"-21'	3	5.5	16"	6.7 lbs.
SIL 365-36	LONGBOY	4.8' - 12'	2	6	14.2"	4.3 lbs.
SIL 272-12	ZUBAT	5.5' - 9'	1	7	13"	2.3 lbs.
SIL 272-15	ZUBAT	6.6' - 11'	1	7	13"	2.6 lbs.
SIL 272-18	ZUBAT	7.7' - 13'	1	7	13"	4.9 lbs.



SIL 371-42 • HAYATE 420  
SIL 372-42 • HAYATE 420  
SIL 373-42 - Spare Blade only  
SIL 375-70 - Sickle only



SIL 178-39 • HAYAUCHI  
SIL 179-39 • HAYAUCHI  
SIL 177-02-03 - Spare Blade



SIL 272-12 • ZUBAT  
SIL 272-15 • ZUBAT  
SIL 272-18 • ZUBAT  
SIL 271-33 - Spare Blade



SIL 365-36 • LONGBOY (Head folds to compact 4'8") - 14.2" blade, 6 teeth/inch  
SIL 366-36 • Spare blade

**NEW Accessories for Silky Saws**



**Sintung Lopper Head**  
Ratchet-operated lopper head offers precise, easy pruning. Designed for quick replacement of the saw head on a Silky Hayauchi pole saw.  
**SIL 16339R-P** - 1 1/2" cut • 2.4 lbs.



**Hook Fox**  
Hook accessory for hanging pole saw on branch or pulling branch down. Designed for HAYAUCHI, HAYATE and LONGBOY pole saws.  
**SIL 425-01**



**HEAVY DUTY ALUMINUM ADJUSTABLE POLE SAW**

Heavy duty aluminum adjustable pole in three sections telescopes to any length with a strong lock collar. Blade attaches to pole with push button snap. **Order pole and saw for complete unit.**

Telescoping pole 4.6' to 10'  
**ARS SC-EXP33** • 3.4 lbs.

Telescoping pole 6.2' to 15.2'  
**ARS SC-EXP45** • 4 lbs.

Telescoping pole 7.25' to 18.6'  
**ARS SC-EXP55** • 5 lbs.

16" curved saw blade with hook, bark blade and grip  
**ARS SA-UV40** • 1 lb.



ARS SC-EXP33

ARS SC-EXP45

ARS SC-EXP55



**ARS SC-JG-4**  
Adapter - To attach pull string lopper heads to ARS EXP poles

ARS SA-UV-40  
Head for pole



BAR Z555+S	17", 5.5mm tooth pitch, curved raker blade saw. Fits Z555P, P1, P2 with sheath • 1.7 lbs.
BAR B555	16.5" long, cuts 1 1/2", pruner head • 2.5 lbs.
BAR Z555P	6'2" - 15'1" pole only, adjustable • 4.2 lbs.
BAR Z555P1	4'11" - 11'7" pole only, adjustable • 3.3 lbs.
BAR Z555P2	7'6" - 19'2" pole only, adjustable • 5 lbs.
BAR Z555PR	9.5" aluminum pole adapter, required for B555 head to Z555 poles • 5 oz.
BAR Z655PR	9.5" aluminum pole adapter, required for Z head to male pole ferrule • 5 oz.
BAR ZHead	6" aluminum universal saw blade mount (head only) • 9 oz.

**Order pole and head for complete unit**



BAR Z555+S



BAR ZHead



BAR B555



BAR Z655PR

BAR Z555PR



BAR Z555P

BAR Z555P1

BAR Z555P2

**TELESCOPIC POLE SAWS**

Adjustable Poles

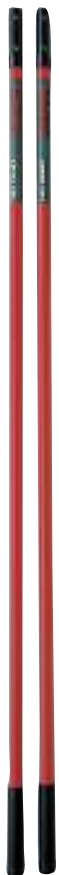

**13' ARBORIST TREE PRUNING SYSTEM**

Forged Coronium™ steel alloy Radial Arc™ blade with 1 3/4" diameter cutting capacity

Compound-action dual-pulley system triples your cutting power

Fully heat-treated, forged Coronium™ steel hook

16" Razor Tooth Saw™ blade and quick-connect ferrule (AC 7672)

Two 6' high-strength fiberglass pole sections can be combined or used separately with saw and pruning head

High strength, heat treated, anodized aluminum pole connectors

**COR TP-6881**- kit • 12 lbs.



**CORONA TP6870**

Professional 14' Compound Action Tree Pruner. TP6870 head with 13" razor tooth saw. Lightweight fiberglass pole telescopes from 7'-14' with twist lock adjustment.

**COR TP-6870** • 6 lbs.

**ADJUSTABLE POLE ONLY**

Corona fiberglass pole adjusts from 7' - 14'

**COR 6870-11** • 3.35 lbs.

**POWER TOOL™ EXTENSION TREE PRUNER**

Telescoping fiberglass handle 6'-12' STALOK™ locking system. 15" saw blade. 1" capacity head. **SEY TP612** • 6 lbs.

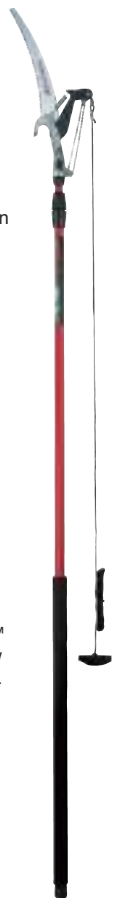

Fixed Units



*Allen Pole Pruner*

**Northeast Growers Choice for Fruit & Ornamentals**



Allen head



Allen handle

Strong, lightweight aluminum pole, riveted to a cast aluminum head complete with sharp steel cutting blade. Operating wire inside the pole is attached to a hardened steel operating lever with vinyl hand grip. Handle is riveted to the pole. Available in 6', 8', and 10' pole lengths.

**Note: 6' and 8' delivered by UPS. 10' truck freight only.**

- ALL AL06**  
6' • 3 lbs.
- ALL AL08**  
8' • 3.5 lbs.
- ALL AL10**  
10' • 4 lbs.



*Cutwell*

**Western Fruit Growers Choice**



Cutwell head



Cutwell handle

Cutwell offers the most advanced easy-to-use pump-style aluminum pole available in today's market. The knife is hardened spring steel with an activator rod and spring inside the pole so it is protected from limbs and shrubs. The anodized aluminum pole is available in 6', 8', 10', 12', 14', 16'

- CUT A-01-06**  
6' • 3.5 lbs.
- CUT A-01-08**  
8' • 4 lbs.
- CUT A-01-10**  
10' • 4.5 lbs.
- CUT A-01-12**  
12' • 5 lbs.
- CUT A-01-14**  
14' • 5.5 lbs.
- CUT A-01-16**  
16' • 6 lbs.

Heavy Duty LongReach™ Pruners

**ARS L SERIES**

The blade and unit have been designed to provide the best possible cutting leverage and durability. 3/4" cutting capacity.

Recommended for the hardest long reaching jobs.

**Available in 3 fixed lengths.**



Drop forged blades provide better cutting leverage and stay sharp longer while hard chrome plating on the blades resists rust and corrosion.



Bigger leaning blade with thicker arm provides extra strength and durability.

**All blades are drop forged with a cutting capacity of 3/4".**

**ARS LA-180L12**  
4' OAL • 1.5 lbs.

**ARS LA-180L18**  
6' OAL • 1.8 lbs.

**ARS LA-180L21**  
7' OAL • 2 lbs.



**JAM LS6F** - 6' Base pole, green  
**JAM LS6** - 6' Extension pole, green  
**JAM PS3FP** - Pole saw head w/adaptor  
**JAM SB13TE** - 13" Blade  
**JAM PH11** - Pruner head 1" capacity  
**JAM PHA11** - Adapter  
**JAM PR20** - Rope

**JAM FG6** - 2 6' Extension poles, yellow  
**JAM PS3FP** - Pole saw head w/adaptor  
**JAM SB13TE** - 13" Blade

**JAM FG6** - 2 6' Extension poles, yellow  
**JAM JA14** - Pruner head 1 1/4" capacity  
**JAM PHA14** - Adapter  
**JAM PR20** - Rope

**JAM TP12F** - Telescoping pole, 6'-12'  
**JAM TP14F** - Telescoping pole, 7'-14'  
**JAM JA14** - Pruner head 1 1/4" capacity  
**JAM PHA14** - Adapter  
**JAM PR20** - Rope

## Curved Blades for Pole Saw Pruners

All fit SNC 20Head, JAM FG3SFP and JAM PS3FP

<b>ARS SB-CT32F1</b>	Chrome 13" turbocut
<b>ARS SB-CT34F1</b>	Chrome 13" turbocut with hook
<b>ARS SB-UV32F1</b>	Chrome 13" super turbocut
<b>ARS SB-UV34S1</b>	Chrome 13" super turbocut with hook
<b>BAR Z13-1</b>	Chrome 13" Tiger Tooth™
<b>BAR Z14-1</b>	Chrome 14" Tiger Tooth™
<b>BAR Z17-1</b>	Chrome 17" Tiger Tooth™
<b>SNC 20B</b>	Non-stick coated 13" razor cut
<b>JAM SB13TE</b>	Chrome 13" TriEdge™
<b>JAM SB16TE</b>	Chrome 16" TriEdge™
<b>JAM SB13TEH</b>	Chrome 13" TriEdge™ with hook
<b>JAM SB16TEW</b>	Chrome 16" TriEdge™ with hook

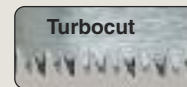
**Turbocut**

3 angles sharpened, impulse hardened

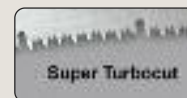
**Super Turbocut**

3 angles sharpened, impulse hardened with gullets

**Tiger Tooth™**

Precision ground at 3 angles and impulse hardened chrome plated

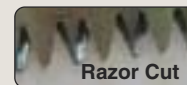
**Razor Cut**

Precision sharpened for smooth cutting, non-stick coating



**TriEdge™**

Sharpened at 3 angles and hard chrome plated with impulse hardened teeth for increased wear resistance

# How to choose and order product

1. Choose heads (saw or pruner) see page 29
2. Choose adapter, if necessary, to attach head to pole see pages 28 and 29
3. Choose pole you require see page 28
4. Add rope, if necessary, to operate head see page 29
5. Choose saw blade to fit sawhead see page 27

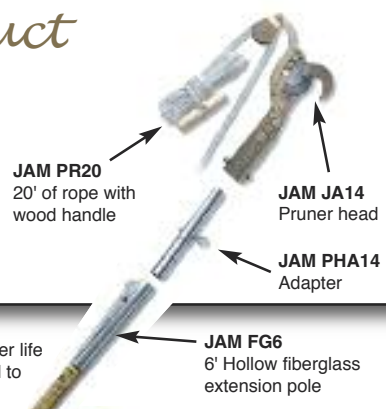
**Suggestion: Keep same manufacturer for head, adapter and pole to assure proper fit**



## Fiberglass Poles

High quality professional tree care and line clearance tools for longer life and safer handling. Manufactured with a non-fiberglass surface veil to prevent fibers from blooming to the surface. JE series poles are individually tested to 100 KV per foot for five minutes. All poles are interchangeable male ferrule to female ferrule with exterior leaf spring locking button.

- JE Series Foam Core Poles** The highest quality fiberglass pole
- FG Series Hollow Poles** Most popular pole
- LS Series Landscape Poles** A light duty option

Following poles stocked. Others available by special order



### JE Series Yellow color

- JAM JE6** 1 1/4"x6' Extension pole (M-X-F) • 2.4 lbs.
- JAM JE6F** 1 1/4"x6' Base pole with rubber cap (F-X Cap) • 2.5 lbs.



### FG Series Yellow color

- JAM FG4** 1 1/4"x4' Extension pole (M-X-F) • 1.4 lbs.
- JAM FG4F** 1 1/4"x4' Base pole with rubber cap (F-X cap) • 1.5 lbs.
- JAM FG6** 1 1/4"x6' Extension pole (M-X-F) • 2.1 lbs.
- JAM FG6F** 1 1/4"x6' Base pole with rubber cap (F-X cap) • 2.2 lbs.
- JAM FG8** 1 1/4"x8' Extension pole (M-X-F) • 2.8 lbs.
- JAM FG8F** 1 1/4"x8' Base pole with rubber cap (F-X cap) • 2.9 lbs.
- JAM FG3SFP** 1 1/4"x3' Saw head XM (for saw only) • 1.4 lbs.



### LS Series Green color

- JAM LS6** 1 1/4"x6' Extension pole (M-X-F) • 2 lbs.
- JAM LS6F** 1 1/4"x6' Base pole with rubber cap (F-X cap) • 2 lbs.

## Double Lock™ Telescoping Poles



A lightweight telescoping pole that eliminates the need for multiple poles. These poles employ a unique two-stage locking mechanism that ensures that poles will not collapse.

**JAM TP12F** Telescoping fiberglass pole 6' - 12' with a female ferrule one end and cap other end. Adapt saw and/or pruner heads using PHA14 or PHA11 adapters (order separately).

**JAM TP14F** Same as above 7' - 14'



**Heavy Duty Vinyl Pole Bag**  
Holds four 6' poles and pruner head. Carrying straps.  
**JAM B-6V**

### BIG SHOT

Shoots throw bags and line through tree limbs. Delivers line up to 200'. Often used with two Jameson 4' extension poles



**JAM BS1**



**Wood Poles - All interchangeable (Male ferrule fits female ferrule. Female ferrule has leaf spring with locking button)**

Peavey Head Pole - 1 1/4" x 6' long. Tapered wood top x male ferrule  
**PEA TE-011-072-T946** • 2.25 lbs.



Peavey Extension Pole - 1 1/4" x 6' long. Female ferrule top x male ferrule  
**PEA TE-011-072-0947** • 2 lbs.



Peavey Adapter Pole. 1 1/4" x 14" long. Tapered wood top x male ferrule  
**PEA TE-011-014-0961** • .5 lb.



Octagonal ash poles (8-sided) X 1 1/4" diameter tapered one end. Available by special order. These are freight only items.  
**PEA QE011-144-0933** • 1 1/4" x 12' wood pole  
**PEA QE011-168-0934** • 1 1/4" x 14' wood pole





### Fiberglass Poles



SnapCut 106FG - Extension pole, foam filled. 1 1/4" x 6' long. female ferrule top x male ferrule  
**SNC 106FG** • 2.25 lbs.



- JAM PH11** 1" cap., center cut, pruner head requires PHA11 adapter • 1.6 lbs.
- JAM PH12** 1.5" cap., center cut, pruner head requires rope & PHA12 adapter • 3.8 lbs.
- JAM JA14** 1.25" cap., side cut, pruner head fixed pulley, requires rope & PHA14 adapter • 1.8 lbs
- JAM JA14S** Same as JA14 but has swivel pulley allowing side pull, requires rope & PHA14 adapter • 1.9 lbs.
- JAM JA14DP** Same as JA14 but has 2 pulleys for leverage making it easier to pull, requires rope only, adapter supplied • 1.9 lbs.

Adapters for pruner heads and saw heads
 JAM PHA11 • .4 lb.
 JAM PHA14 • .4 lb.
 JAM PHA12 • .6 lb.

- JAM JA34DP** Big Mouth 1 3/4" pruner with double pulley (not pictured)
- JAM PS3FP** Pole saw head with adapter, center bolt and pull pin design • .6 lb.
- JAM FG3SFP** Pole saw head attached to 3' fiberglass pole section with male ferrule on pole (Special order for JE or LS styles) • 1.4 lbs.
- JAM PR20** 20' rope with wood handle
- JAM CL-1** Cable Lifter - Designed to safely lift copper, fiber optic and coax cable.
- JAM WR-1** Wire Raiser - Designed for placing cable on rollers, blocks and hardware or for moving tree branches
- JAM PRI-7.5** Rope insulator 7", 60KV 5 min.
- JAM PRI-12** Rope insulator 12", 100KV 5 min.

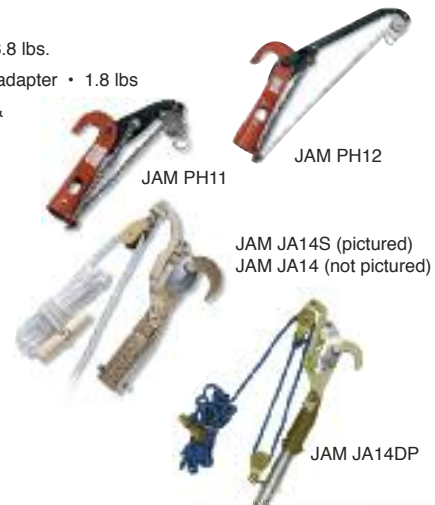

POLE SAW/PRUNER HEADS



**JAM PRI-7.5 or JAM PRI-12**



**Leather Pruner Guard**



**JAM 32-18**



- BAR B555** 1.5" cap., compound lever action for easy cutting • 2.5 lbs.
- BAR ZHead** 6" aluminum universal saw blade mount • 9 oz.
- BAR Z655PO** Adapts Z555 saw to Jameson or SNC poles • 5 oz.
- BAR Z555PR** Adapts B555 head to Z555 poles • 5 oz.
- BAR Z655PR** Adapts B555 head to Jameson or SNC poles • 5 oz.



- SNC 20** Saw head with 20B blade, requires PEA or PHA11 adapter • 1 lb.
- SNC 20Head** Saw head only, requires PEA or PHA11 adapter • .5 lb.
- SNC 2011** Head with teflon coated saw blade
- SNC 2011B** Teflon coated, straight cut blade for SNC 2011 head only
- PEA TE-011-014-0961** Peavey adapter - *see page 28*



**BAHCO P34-37**  
1.25" bypass side cut head with rope/handle. Requires PHA14 adapter • 2.18 lbs.



**MAR PH-4R**  
1.25" bypass side cut head, requires rope and PHA14 adapter 2.18 lbs.



**CORONA COR 6880-8**  
Heavy duty compound action head, 1.75" cap., 19" long, requires PHA14 adapter • 2.5 lbs.



**CORONA COR 6870-8**  
Chain driven, compound action pully system. Requires adapter PEA or PHA11 • 2 lbs.



**PTF 0798RP**  
1" cap. long arm for leverage, with rope, requires PEA adapter • 1.5 lbs.

**PTF 0798QP**  
1" cap. short arm for dense growth, with rope, requires PEA adapter • 1.5 lbs.

**FELCO**

SWISS MADE

Leather holster with waxed thread and rivets now has belt loops and metal pocket clip on back side. CAN BE USED FOR BELT OR POCKET!  
**FEL F910** • 5 oz.



BACK



This practical holster is designed to fit ALL Felco pruners. Protects clothing while providing easy access on the job. High tension metal clip for quick attachment.

**FEL F912** • 8 oz.



BACK



Popular holster fits most pruning shears made. Extra riveting for long lasting use.  
**FEL F919** • 8 oz.



Multi-use tool holder with belt loop.  
**FEL F920** • .75 lb.



Designed for Felco 20 & 21 loppers, but can be used for just about any lopper made. Fits on belt. Leg strap use assures firm placement.

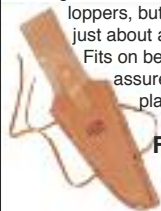

**FEL F918**  
 • .75 lb.

BARNEL USA



9" deluxe holster w/clip. Fits secateurs, pruners, Z210 and Z180 saws.  
**BAR BLS914** • 2 oz.



9" Cordura holster w/clip, economical, fits many hand pruners & folding saws  
**BAR BLS913** • 1.8 oz.



Pruning saw sheath, snap hook on the front, snap and belt loop. 16.5"L  
**BAR BLS934** • 8 oz.

**ARS**



Leather pouch with clip for 300 & 3000 series pruners  
**ARS ACC-LP300** • 3 oz.



Leather pouch with clip for scissors  
**ARS ACC-SSLP** • 3 oz.

**TOOL BAGS AND BELTS**

**SAW BELT AND BAG**

Red cordura material, hang ORC16 Wheeler saw from hook. 2 pockets for hand tools.

**FRI ABB16** • .5 lb.

Bag without hook. Use for small pruners or horticultural tools. 2 pockets  
**FRI ABB17** • .5 lb.



BARNEL USA



**NEW**

**Leather Tool Belt/Bag**

20" x 9" Double riveted. Includes pouch for pruners, loop for loppers and pocket for accessories. Adjustable quick release belt.  
**BAR BTC-2** • 14.5 oz.

**CORONA**

**NEW**

**Nylon Scabbard**

*Universal design* fits handpruners and folding saws. Easy to carry using metal clip or belt loop. Front pocket for sharpening stone.

**COR AC-4510**



**WEAVER LEATHER**

**SHAPED PRUNER POUCHES**

All leather, lock stitched and riveted. With belt clip and/or belt slots as noted.



**WEA 08-97200-8**  
 8" with clips and slots



**WEA 08-97220-8**  
 8" with shaped knife clips and slots. Riveted knife pouch with snap-close flap.



**WEA 08-97220-9**  
 9" with shaped knife clips and slots. Riveted knife pouch with snap-close flap.

**PISTOL TYPE PRUNER POUCHES**

Holds hand pruners or tools snugly in place without straps. Soft, brown oil tanned leather. Belt loop snaps over 2" belt.



**WEA 08-97202-8**  
 8" long with 5" deep pocket

**WEA 08-97202-9**  
 Same style as 0897202-8. 9" long with 6" deep pocket



**WEA 08-97202-9P**  
 9" long with 6" deep pocket and 3" deep knife pouch

**FOLDING SAW SCABBARD**

All leather with belt slots and belt clip. 3 1/4" deep, 7" wide, and 12 1/4" long

**WEA 08-02015**















**Match your saw to the right scabbard**



**SAW SCABBARDS**

This section: 2 1/4" top width X 1" bottom width X 14 1/2" front length X 19" back length  
 Fits all 13" – 14" curved saws, COR 7010, 7130, 7120, BAR Z13, 14, Fanno FI-1311, FS 14, Silky Zubat and others

Leather-Part Number	Description	Rubberized Belting-Part#
 <b>WEA 08-02008</b>	Straight back with belt loop and dee ring with snap	 <b>WEA 08-03008</b>
 <b>WEA 08-02009</b>	Curved back with belt loop and dee ring with snap	 <b>WEA 08-03009</b>
 <b>WEA 08-02010</b>	Straight back with dee ring and snap, no belt loop	 <b>WEA 08-03010</b>
 <b>WEA 08-02011</b>	Curved back with dee ring, snap, no belt loop	 <b>WEA 08-03011</b>
 <b>WEA 08-02012</b>	Straight back, attached pruner pouch, dee ring, no belt loop, no snap	 <b>WEA 08-03012</b>
 <b>WEA 08-02013</b>	Curved back, attached pruner pouch, dee ring, no belt loop no snap	 <b>WEA 08-03013</b>



Weaver leather scabbards are made from top grain steer hide harness leather. This leather goes through a special tanning process that makes it durable and weather-resistant. Rubberized belting scabbards are also very durable and weather-resistant; they are an excellent economical choice. All scabbards are sewn with heavy weather and mildew resistant bonded nylon thread and riveted at stress points.



**SHEARING KNIFE SHEATH**  
 Leather stitched and riveted. Fits blades 1 1/2" x 14"-18"  
**WEA 08-97204**

**POLE SAW SCABBARD**  
 All leather strap on scabbard for pole saw blades. Fits standard size blades.  
**WEA 08-02025**

This section: 2" top width X 1" bottom width X 13 3/4" front length X 19" back length  
 Fits 12" – 14" straight saws

	Curved back with pruner pouch, dee ring, no belt loop or snap		Curved back with dee ring, no belt loop or snap
---	---	--	---

**LARGE CURVED SAW SCABBARDS**  
 #25 Scabbards

For Fanno #20 and other large saws. Compare dimensions with your saw.  
 Top width- 3 1/3", Bottom width- 1 3/4", Front length- 21 1/2", Back length- 24"

#27 Scabbards

For Fanno #22, #24, COR RS-7160 and other saws. Compare dimensions with your saw.  
 Top width- 4 1/4", Bottom width- 1 3/4", Front length- 21 1/2", Back length- 27 3/4"

**HARNEY USA SCABBARDS**



19" leather, fits BAR Z17, belt loop, leg strap  
**BAR BLS937**

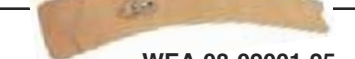
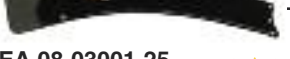

20" ABS plastic, economy, fits curved 13" & 14" saws, belt loop  
**BAR Z1314S**

 <b>WEA 08-02001-25</b> <b>WEA 08-02001-27</b>	Dee ring on back. Snap hook on front	 <b>WEA 08-03001-25</b> <b>WEA 08-03001-27</b>
--	--------------------------------------	---



Many other tool sheaths available by special order to fit axes, Pulaski tools, etc.

# Tree Fruit and Ornamentals

## MAI STAR-35

The STAR 35 is a traditional pneumatic shear with a single piston and spring return. Its powerful and swift cutting performance of 3 strokes/second is unmatched in the field. The STAR 35 is an excellent hand-held shear for fruit trees and landscape maintenance. A special adapter allows the shear to be connected to an extension pole without disassembling the tool.



### MAI STAR-35 Hand-Held



## MAI STAR-30F

The shear has a double piston system and reduced hand grip diameter.

The blade/anvil design is perfect for young fruit trees.



### MAI STAR-30F Hand-Held

## MAI SE-4

The SE-4 is the industry's premier shear for pruning fruit trees and ornamentals. Rugged and lightweight, this powerful shear is built for speed, easy handling, and precision cutting. It is advisable to use the shear with an extension pole for better reach and maneuverability. A telescopic extension pole is recommended for even greater flexibility.



### MAI SE-4 Hand Held

## TELESCOPIC MODELS

- MAI SE-4-02T w/telescopic extension (OAL: 3'1"-4'3")
- MAI SE-4-04T w/telescopic extension (OAL: 4'8"-7'3")
- MAI SE-4-06T w/telescopic extension (OAL: 6'7"-11'1")
- MAI SE-4-04 w/40' extension
- MAI SE-4-06 w/60' extension
- MAI SE-4-09 w/80' extension



## EXTENSION POLES

Extension poles are available in aluminum. Choose telescopic or fixed length. Various lengths are available in each type.

"Air" type fixed-length

- MAI EXA-04A (40')
- MAI EXA-06A (80')

"Air" type telescopic

- MAI EXA-02T (1'10" - 30')
- MAI EXA-04T (35' - 60')
- MAI EXA-06T (54' - 910')

# Lopper

## MAI STAR-50

The Model STAR-50 is the most powerful shear in the Campagnola line. The shear cuts tree limbs up to 2 1/4" thick with only the light touch of the trigger - often eliminating the need for a chain saw.

The shear's performance is particularly appreciated in hardwood and deadwood and is widely used in nut, citrus, cherry and blueberry pruning, as well as in forestry and commercial grounds maintenance.

- MAI STAR-50-02 w/20' extension
- MAI STAR-50-04 w/40' extension
- MAI STAR-50-05 w/60' extension
- MAI STAR-50-06 w/80' extension



# Chain Saw

## MAI ST-3

For heavy duty tree pruning turn to the model ST-3 Chain Saw. This powerful, lightweight saw has been a reliable workmate of farmers and grounds maintenance crews for many years. The saw has an 8" bar and cuts up to 6" limbs. A built-in lubricator oils the bar and chain while you work.



Models:

- MAI ST-3 Hand-Held
- MAI ST-3-02T w/telescopic extension (OAL: 3'8"-4'8")
- MAI ST-3-04T w/telescopic extension\* (OAL: 5'3"-7'8")
- MAI ST-3-06T w/telescopic extension\* (OAL: 7'2"-11'8")
- MAI ST-3-04 w/40' extension
- MAI ST-3-06 w/80' extension

\* Available in fiberglass

MODEL	WEIGHT	CUTTING CAPACITY	CFM	PSI
STAR 30V	1.25	1.00	1.94	140*
SUPERSTAR	1.30	1.00	1.94	140*
STAR 30F	1.25	1.15	1.94	140
STAR 35	1.45	1.25	2.12	140
SE-4	1.75	1.45	2.12	140
SE-4 W/EXT	3.41-4.51	1.35	2.12	140
ST-3 LASER	5.18	6.00	14.12	140
ST-3 W/EXT	6.17-8.26	6.00	14.12	140

Recommended hose size: 3/8" ID - STAR 30, ST 3  
1/4" ID - all shears except STAR 50

\*50 PSI for sheared pruning



# Compressors

CAMPAGNOLA Pruning Compressors are heavy duty commercial units designed to operate our full line of pruning tools at maximum efficiency. The compressors represent the latest in innovative design and technology and are engineered to meet the rigorous demands of outdoor pruning.



MAI ECOPLUS 1500

PTO Driven Compressors are very popular and are used widely in orchards and vineyards.

MODEL	TANK CAPACITY	MAX PSI	CFM	HP	PTO/ RPM	WEIGHT	SHEAR (SE-4)	SAW
<i>PTO Driven</i>								
MAI ECOPLUS 520	5.8	160	18.3	18	300	181	6	1
MAI ECOPLUS 950	5.8	160	33.4	25	300	225	11	2
MAI ECOPLUS 1500	5.8-7.4	160	53.3	30	300	340	19	3
<i>Gas Driven</i>								
MAI LB 14 (8hp Honda)	8	160	17.5	8	—	195	6	1
MAI LB 10 (4hp Honda)	4	150	4.5	4	—	60	2	—

## Vineyard

### MAI SUPERSTAR 2

The world's #1 pneumatic vineyard shear has been improved. The newly designed Super Star 2 boasts a 15% increase in power, ice-free valve, and a sealed front for total protection of the inner parts. The shear is excellent for berries, young fruit trees, and nursery stock.



### MAI SUPERSTAR 2

### MAI STAR 30V

**NEW**

This ergonomic vineyard shear has a double piston design that not only generates considerable power - it reduces hand grip diameter and delivers a smooth stroking action. The blade/srivil design is perfect for vineyard pruning.



### MAI STAR30V

### Popular LB-10 System Packages



- LB-10-61-04 (1) STAR-50-04 Tool, (1) HP-508 Hose, (1) LB-10 compressor
- LB-10-41T-04T (1) SE-4-04T Tool, (1) HP-506 Hose, (1) LB10 compressor
- LB-10-41-04 (1) SE-4-04 Tool, Fixed length (1) HP-506 Hose, (1) LB10 compressor
- LB-10-42T-04T (2) SE-4-04T Tools, (2) HP-506 Hose, (1) LB-B compressor
- LB-10-42-04 (2) SE-4-04 Tools, Fixed length (2) HP-506 Hose, (1) LB-B compressor
- LB-10-21\* (1) Star 35 Tool, (1) HP-506 Hose, (1) LB-10 compressor
- LB-10-22\* (2) Star 35 Tools, (2) HP-506 Hose, (1) LB-10 compressor

\* Super Star 2, Star 30 substituted at no additional charge  
**LB-14 System packages available special order.**

#### Hose For Air Tools

- MAI HP-506 - 1/4 ID Poly hose X 50' with fittings
- MAI HP-1006 - 1/4 ID Poly hose X 100' with fittings

- MAI HP-508 - 3/8 ID Poly hose X 50' with fittings
- MAI HP-1008 - 3/8 ID Poly hose X 100' with fittings
- MAI HC-5038 - 3/8 ID Coil hose X 50' with fittings



## HYDRAULIC PRUNERS



Pruners, Chain Saws, Circular Saws available.

Contact OESCO for information.

ALL PARTS AND SERVICE FOR LIMB LOPPER TOOLS BY GREENLEE FAIRMONT



Powerful, light, ergonomic... this high-tech tool combines FELCO's unmatched know-how with the latest research of portable electric pruning shears.

- Cutting head opening capacity up to 1.2"
- Average duration of use without recharging - full day of pruning
- Average charging time - 5 hours
- Integrated tool diagnostic software
- Weight of shear - 1.81 lbs.
- Weight of battery pack - 4 lbs.
- High-tech battery pack with optimum performance between 23° F and 86° F



- FEL F800 - right hand
- FEL F800G - left hand
- FEL F810 - 1 1/2" cutting capacity



**NEW**

The new Kaiman electronic pruner from Volpi of Italy is rapid, powerful and lightweight.

Prune for 2 days before having to recharge the tool!

- Cutting capacity up to 1.5"
  - Progressive cut with two selectable opening options.
  - Ergonomic tool with heavy duty ball swivel where the cord attaches to the tool.
  - 48 volt NiMH rechargeable battery in ergonomic knapsack with adjustable waist band and holster
  - Average charging time - 8 hours
  - Weight of tool - 1.9 lbs.
  - Weight of backpack with battery - 6.7 lbs.
- VOL KE50AR**

# ECHO

**5** year  
Consumer  
Warranty



Contact us for a complete listing of in stock ECHO products and pricing

OESCO, Inc. has been selling Power Pruners since they were made by Technic Tool over 17 years ago. We know a good product when we see it, and Echo has been a dependable and diversified line of high performance, handheld outdoor power equipment. Our lead small engine mechanic attends Echo School each year to make sure we are on top of any changes and new developments that come along. We tested a lot of equipment before we chose Echo, and we've always been happy with our choice. Call us so we can tell you what is new from Echo!



## SHOVELS



**SEY S700 - Round point shovel**  
9"x12" head size • 48" fiberglass handle, rolled step • 4.7 lbs.



**SEY S700D - Round point shovel**  
9"x12" head size • 29" fiberglass "D" handle, rolled step • 4 lbs.



**SEY S701 - Square point shovel**  
9.5"x11.5" head size • 48" fiberglass handle, rolled step • 5 lbs.



**SEY S701D - Square point shovel**  
9.5" x 11.5" head size, 48" fiberglass "D" handle, rolled step • 4.5 lbs.



**SEY S710 - Super shovel**  
8.8" x 11.2" head size, 48" fiberglass handle, front turned step • 5 lbs.



**SEY S710D - Super shovel**  
8.8" x 11.2" head size, 29" fiberglass "D" handle, front turned step • 4.5 lbs.



**SEY S712 - Closed back round point**  
8.8" x 11.2" head size, 48" fiberglass handle, front turned step • 4 lbs.



**SEY S605 - Garden Spade**  
6.9"x12" head size • 48" fiberglass handle, front turned step • 4.5 lbs.



**SEY S605D - Garden Spade**  
6.9"x12" head size • 29" fiberglass "D" handle, front turned step • 4.5 lbs.



**SEY S704 - Drain spade**  
5.5" x 14" head size, 48" fiberglass handle, rolled step • 4.5 lbs.



**SEY S704D - Drain spade**  
5.5" x 14" head size, 29" fiberglass "D" handle, rolled step • 4 lbs.



**SEY GS18 - Grain scoop**  
14.25"x19" head • 51" fiberglass handle • 4.5 lbs.

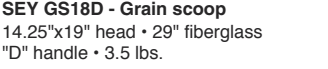

**SEY GS18D - Grain scoop**  
14.25"x19" head • 29" fiberglass "D" handle • 3.5 lbs.

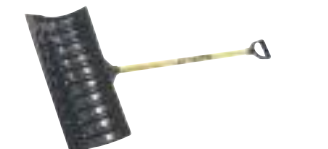

**SEY PP100 - Snow pusher**  
12"x24" Black ABS head, 44" fiberglass "D" handle • 4 lbs.



**SEY PS200 - Snow shovel**  
13.5"x18" Blue ABS head, 44" fiberglass "D" handle • 4 lbs.

## FORKS



**SEY BF-25 - Bedding fork**  
11"x12" Welded steel head, 48" wood handle • 4.5 lbs.



**SEY SP30 - Spading fork**  
7.25"x11.25" Forged steel head 30" fiberglass "D" handle • 3.5 lbs.



**SEY CF5 - Compost fork**  
9"x11.5" Forged steel head 48" fiberglass handle • 3 lbs.

## SCRAPERS/CHISELS



**SEY SC-30 - Scraper**  
7"x6" Forged head, 54" hardwood handle • 3.5 lbs.



**SEY IC-30 - Ice chisel**  
3.5"x6" Forged head, 48" hardwood handle • 3.2 lbs.

## RAKES



**SEY BR16 - Bow rake**  
16.25"x3.25" head, 60" fiberglass "D" handle • 3.3 lbs.



**SEY PR24 - Leaf rake**  
26 tines, 24" Black poly head, 51" fiberglass handle • 2 lbs.



**SEY LF-25 - Lawn rake**  
24" tines, 24" head size, Steel, spring brace, 54" wood handle • 2.5 lbs.



**SEY SR22 - Lawn rake**  
24" tines, 22" head size, Steel spring brace, 54" fiberglass handle • 3.2 lbs.



**SEY LR24 - Landscape rake**  
24" Aluminum head with brace 66" fiberglass handle • 3.7 lbs.

**SEY LR36 - Landscape rake**  
36" Aluminum head with brace 66" fiberglass handle • 6.5 lbs.



**SEY RR-25 - Roof rake**  
22"x5.5" Aluminum head 16", 3-pc. Aluminum handle • 5.7 lbs.

## DIGGERS



**SEY DG-10 - Heavy-duty Atlas Digger** • 4" hardwood handle 8 lbs.



**SEY DG-18 - Giggs digger, single Blade action** • 4.5" hardwood handle. 11 lbs.

Powercore™ solid fiberglass reinforcing rod from shank to handle. Strong, yet lightweight hollow handle, ProGrip™ for a sure grip on handle. The most rugged fiberglass handle available for construction, landscaping and gardening.

## HOES

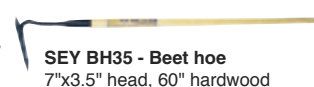

**SEY BH35 - Beet hoe**  
7"x3.5" head, 60" hardwood handle • 2.3 lbs.



**SEY SH37 - Southern Meadow Hoe**  
7" x 3.5" head, 60" hardwood handle. • 3 lbs.

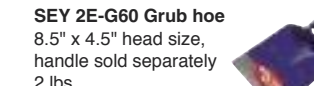

**SEY 2E-G60 Grub hoe**  
8.5" x 4.5" head size, handle sold separately 2 lbs.

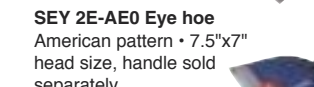

**SEY 2E-AE0 Eye hoe**  
American pattern • 7.5"x7" head size, handle sold separately. 2 lbs.

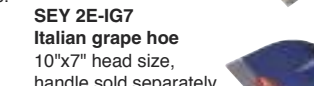

**SEY 2E-IG7 Italian grape hoe**  
10"x7" head size, handle sold separately. 2.5 lbs.



**SEY DG-AEH - Handle for eye and grub hoes**  
54" wood circular cross section • 2 lbs.



**SEY DG-IGH - Handle for Italian grape hoe**  
40" wood oval cross section • 2 lbs.

## PICK-MATTOCK



**SEY MP5FG - Pick-mattock**  
Steel head, 36" fiberglass handle 7.5 lbs.

## AUGERS



**SEY DW-D1 - Drillwell auger**  
5" steel shaft telescopes to 9', 8"-14" point spread, hardwood handle. • 28 lbs.

## BROOMS



**SEY PB24R - Rough surfaces**, 3.25" poly bristles, 24" head, 60" yellow fiberglass, cushion grip. • 3.5 lbs.



Handles of aircraft quality tubing, heat treated heads. Replacement heads available. Heads easily exchanged with 2 machine bolts.

**DURA RAKES**



- WWM 50** - 8" rake, 64.5" OAL • 2.5 lbs.
- WWM 51** - 12" rake, 64.5" OAL • 2.75 lbs.
- WWM 52** - 18" rake, 64.5" OAL • 3 lbs.
- WWM 53** - 24" rake, 64.5" OAL • 3.75 lbs.
- WWM 54** - 30" rake, 64.5" OAL • 4.25 lbs.



- Sod Rakes**
- WWM 52S** • 3 lbs.  
18" rake, 64.5" OAL
  - WWM 59** • 3.75 lbs.  
24" rake, 64.5" OAL

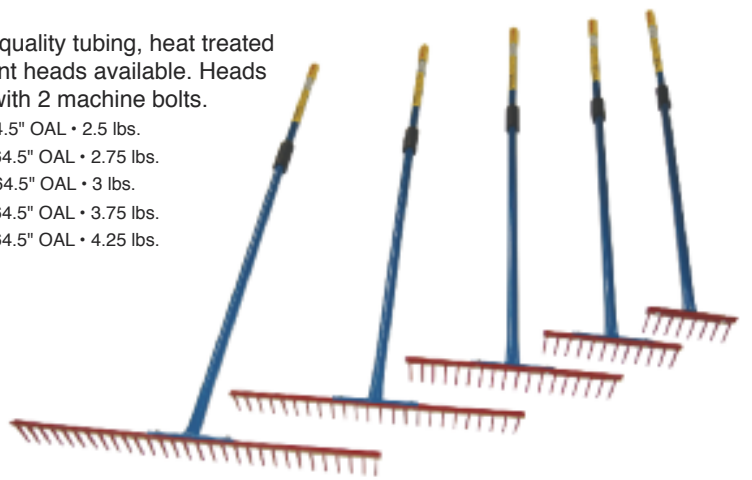

**NURSERY/LANDSCAPE TOOLS**



**Grub Hoe  
WWM 25A**  
5" head  
51" OAL  
5.5 lbs.



**Root Cutter  
WWM 44**  
Very strong, long  
handle, 73" OAL  
15.5 lbs.



**Trench Scoop  
WWM 43**  
3" wide x 10" long,  
sharpened blade with  
root cutter teeth  
62" OAL  
4.5 lbs.



**Brush Hook  
WWM 20**  
8" head  
64.5" OAL  
4.75 lbs.



**Digging Fork  
WWM 45**  
4 tine  
42" OAL  
5.5 lbs.



**Pitch Fork  
WWM DHPF5**  
5 tine, D-Handle,  
42" OAL  
5.5 lbs.

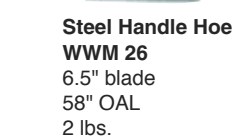

**Steel Handle Hoe  
WWM 26**  
6.5" blade  
58" OAL  
2 lbs.

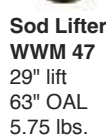

**Sod Lifter  
WWM 47**  
29" lift  
63" OAL  
5.75 lbs.



**Edging Tool  
WWM 19**  
Round head, long handle,  
54" OAL  
5 lbs.



**Mulch Fork  
WWM 42**  
10 tine  
53.5" OAL  
8.25 lbs.



**Pitch Fork  
WWM LHPF5**  
5 tine, long straight handle  
65" OAL  
5.5 lbs.



**Mini Pick  
WWM 17** • 2.3 lbs.  
15" handle,  
2 1/2"W X 6"L Blade,  
1"W X 5 1/2"L Pick



**Featherweight Mini Pick  
WWM 17A** • 1.2 lbs.  
14" handle,  
3 1/2"W X 4 1/2"L Blade,  
1 1/4"W X 5" L Pick



**Cutter Mattock  
WWM 46** • 9 lbs.  
48.75" OAL  
4" wide x 8" long  
blade and cutter edge



**Digging Tool  
WWM 48** • 9 oz.  
The ultimate digging tool. Cuts through roots. Digs in any type of ground cover. Cuts turf, sod easily. 7" blade x 1 3/4" W, 12" OAL with 4" hand guard and 4" of teeth right side. Supplied with a sheath with 3"W X 3.5" deep belt loop.



**WWM KSS**

**KING OF SPADES**

Supplied with 1 foot pad.

- All blades are sharpened and heat treated.
- "D" handles are 1 1/4" in diameter tubular steel shaped to 4" wide inside the "D".
- All tools welded construction.
- Main shank is zinc plated aircraft tubing, super strong, rust resistant, smooth and lightweight.
- New large rubber foot pad 3/4" thick x 1 1/2" wide x 3" long. It can be bolted to either side.
- Long tapered cutting edge, self sharpens during use.



Model	Blade Length/Style	Handle Style	Overall Length	Weight
<b>WWM KSS</b>	13" Square blade	Non-replaceable "D" handle	40"	6.33 lbs.
<b>WWM LHS</b>	13" Square blade	Long, straight handle	63"	6.33 lbs.
<b>WWM KSD</b>	13" Diamond blade	Non-replaceable "D" handle	40"	6.31 lbs.
<b>WWM LHD</b>	15" Square blade	Long, straight handle	65"	7.85 lbs.
<b>WWM KSS-15</b>	15" Square blade	Non-replaceable "D" handle	42"	6.75 lbs.
<b>WWM LHS-15</b>	15" Square blade	Long, straight handle	65"	7.85 lbs.
<b>WWM KSD-15</b>	15" Diamond blade	Non-replaceable "D" handle	42"	6.7 lbs.
<b>WWM LHD-15</b>	13" Diamond blade	Long, straight handle	63"	7.16 lbs.
<b>WWM KSR-15</b>	15" Round edge blade	Non-replaceable "D" handle	42"	5.75 lbs.

**Ultralite Spade**  
 12" Square blade, non-replaceable "D" handle. 40" OAL  
**WWM 12** • 6.5 lbs.

**Ultralite LH Spade**  
 12" Square blade, long, straight handle. 62.75" OAL  
**WWM 12A** • 6.5 lbs.

**GROUND SHARKS**



**COMPACT**

**WWM 36B** - 62" OAL • 4.7 lbs.  
 Long, straight handle, 11" curved blade, serrated edge

**WWM 36A** - 38" OAL • 4 lbs.  
 "D" handle, 11" curved blade, serrated edge

**WWM 36C** • 3.25 lbs.  
 27" OAL, "T" handle, 5"W X 11"L curved blade, 6" of teeth left side NO STEP PAD; Forward facing step

**WWM 36** - 40" OAL • 3.4 lbs.  
**WWM 35** - 36" OAL • 3.25 lbs.  
**WWM 33** - 28" OAL • 3 lbs.  
 "T" handle, 3"W X 12"L curved blade, 5" of teeth left side with step pad

**SHOVELS**

**COMPACT**

**All purpose shovel**  
**WWM 30** • 2.6 lbs.  
 "T" handle, 5"W X 8"L, curved blade. 26" OAL

**WWM DHV-PT-R** • 5 lbs.  
 11" pointed round blade, "D" handle. 42.5" OAL

**WWM LHV-PT-R** • 5.5 lbs.  
 11" pointed round blade with long, straight handle. 62.5" OAL

**LANDSCAPING AND NURSERY TOOLS**

**COMPACT**

**Sampson Ball Handle Spade**  
**WWM 31** • 2.5 lbs.  
 Blade is 4" tapered to 3" diamond X 7" long, NO STEP PAD, Forward facing step. 28" OAL

**Sampson T-Handle Spade**  
**WWM 32** • 2.5 lbs.  
 Blade 4" tapered to 3" diamond X 7" long, NO STEP PAD, Forward facing step. 31" OAL

WWM SHOVELS/SPADES

**SHOVELS**



**COR SS-65000** - #2 Round Point  
Hollow back shovel, 48" long ash wood handle. • 5.5 lbs.



**COR SS-65010** - #2 Round Point  
Hollow back shovel, 30" D-Handle • 5.5 lbs.



**COR SS-66000** - #2 Square Point  
Hollow back shovel, 48" long ash handle. 5.5 lbs.



**COR SS-66010** - #2 Square Point  
Hollow back shovel, 30" D-Handle • 6 lbs.



**COR SF-70000** - #2 Round Point  
Forged shovel, 48" long ash handle. • 6.5 lbs.



**COR SF-70010** - #2 Round Point  
Forged shovel, 30" D-Handle • 6.5 lbs.

**BROOM**



**COR BM-60001** - H-D Landscape Broom  
18" wide head with 60" handle. Brush head has coarse poly, medium steel and medium feathered poly bristles and scraper blade. • 5.7 lbs.

**THE GROUNDSKEEPER II**



**Lightweight Rake**

Because of the material used, this rake is both durable and lightweight. The fiberglass handle and no break co-polymer head make it almost impossible to destroy. NO DOWN PRESSURE - EASY ON THE BACK!  
21" head length, 18 tines, 55" length  
**TRG GK102R** • 2 lbs.



**MATTOCKS**



**COR AX-71020** - Pulaski Root  
Grubbing Tool - 34" Solid-core fiberglass handle with thick molded poly jacket  
Extra-sharp, triangular mattock blade  
7 lbs.



**COR PM-41000** - Pick Mattock  
36" Hickory handle. Forged, tempered steel head. Point and wide mattock blade. 8 lbs.



**COR PM-42000** - Cutter Mattock  
36" Hickory handle. Forged, tempered steel head. Extra sharp cutter blade, extra wide mattock blade. • 7.5 lbs.

**RAKES**



**COR RK-24003** - Spring  
Brace Rake - 24" / 24 Tines  
54" Long wood handle.  
Fan-shaped head, flexible tines.  
1.5 lbs.

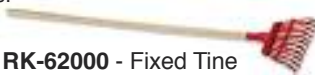

**COR RK-62000** - Fixed Tine  
Shrub Rake - 8" / 11 Tines  
54" Long wood handle. • .8 lb.



**COR RK-63003** - Wide Head  
Leaf Rake - 30" / 30 Tines  
54" Long wood handle. Extra thick vinyl, close spaced, tightly curved tines.  
2 lbs.

**BARNETT USA**

**Steel Rake**

Adjusts 7" to 22" wide, Handle adjusts 35" to 57" long. Alloy steel expandable rake features special tines which dig deep for hard to rake areas. Handle adjusts from 35" - 57". Easy to store. Tines angle right or left.  
**BAR B999** • 2.2 lbs.



**HOES**



**COR SH-61000** - Diamond Hoe  
60" Extra long ash handle, diamond shaped head, 4 sharp edges. • 2.8 lbs.



**COR SH-60000**  
Oscillating Hoe – Small  
60" Extra long ash handle. Small head. • 3 lbs.



**COR SH-60001**  
Oscillating Hoe – Large  
60" Extra long ash handle. Large head. • 3 lbs.

**CULTIVATORS**



**COR SH-22000** - Warren Hoe  
54" Long wood handle, 5"x6" V-shape tempered steel head • 3 lbs.



60" Long ash handle, forged head  
**COR CV-70003** - 3 Prong Cultivator • 2 lbs.  
**COR CV-70004** - 4 Prong Cultivator • 2.5 lbs.

**FORKS**



**COR FK-70000** - 4 Tine Spading Fork  
48" Long northern ash handle. Forged, tempered tines, riveted head connection • 6 lbs.



**COR FK-70010** - 4 Tine Spading Fork  
30" Steel and ash YD grip. • 5.8 lbs.



**COR FK-71003** - 3 Tine Hay Fork  
54" Long ash handle. Light to medium duty fork. Forged, tempered steel head. • 5.5 lbs.



**COR FK-72005** - 5 Tine Manure Fork  
54" Long ash handle. Medium to heavy duty fork. Forged, tempered steel head. • 6.5 lbs.



**COR FK-74010** - 10 Tine Ensilage Fork  
30" Long ash handle with Steel YD grip. Heavy duty fork. • 8 lbs.



The Leader in Diamond Sharpening  
"Let the Diamonds Do The Work"

## Diafold™ Sharpeners

## Diamond Sharpeners



### Diafold Flat File

1/16" thick. 3/4" to 1/4" taper. 4 3/8" long. Great for confined, narrow applications. 5" handles fold and enclose the file. Perfect for hand pruners, loppers, scissors and small shears.

**DMT FFF Fine** - (red) • .21 lb.

**DMT FFC Coarse** - (blue) • .21 lb.



### Diafold Double and Single Sided

Recessed dots provide chip clearance to prevent loading and speed sharpening. 5" handles fold and enclose the file. Great for loppers, spades, shovels, hedge shears and scythes. Choose single or double sided (dual grit).

**DMT FWF - Fine** - (red) • .22 lb

**DMT FWC - Coarse** - (blue) • .22 lb.

**DMT FWX - Extra Coarse** - (black) • .22lb.

**DMT FWFC - Double sided, Fine/Coarse** • .24 lb.

**DMT FWCX - Double sided, Coarse/X-Coarse** • .24 lb.



**NEW**



### Diafold Round Diamond Files

Multi-use tool for quick and easy chain saw maintenance as well as the right honing steel for sharpening any curved edge. 5" handles fold and enclose the file. Available in three sizes. Coarse grit only.

**DMT FCS5C - 5/32"** • .20 lb.

**DMT FCS6C - 6/32"** • .20 lb.

**DMT FCS7C - 7/32"** • .20 lb.



### Diamond Mini-Sharp

Flip open lid/handle, swivel ring for key chain. Lightweight and ultra portable. Great for touching up your tools or knife in the field. 2 11/16" x 1 5/16" x 3/16"

**DMT F70F - Fine** (red) • .10 lb.

**DMT F70C - Coarse** (blue) • .10 lb.

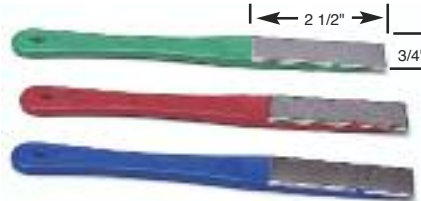

### Diamond Mini-Hone

Only 3/16" thick. Good for bypass and anvil pruners, small shears, scissors and knives. 3/4" x 7" x 3/16".

**DMT D2E - Extra-fine** (green) • .10 lb.

**DMT D2F - Fine** (red) • .10 lb.

**DMT D2C - Coarse** (blue) • .10 lb.

### Diamond Honing Cones

Versatile sharpeners. Use on both curved and straight edge tools. Good for grafting knives, bypass pruners or for touching up wavy edge blades. Choose from two sizes. Half round cones.

**DMT DCMF - Medium** 3/8" to 3/4" diameter x 6"

**DMT DCLF - Large** 3/4" to 1 1/4" diameter x 8"



## Choosing The Right Grit

**Extra Coarse** - Recommended for aggressive removal of metal on damaged tools or for heavy-duty outdoor tools such as axes and lawn mower blades.

**Coarse** - Quickly restores a dull edge to cutting sharp again.

**Fine** - Restores to a fine edge any knife or tool that is slightly dull.

**Extra Fine** - Refines and polishes the sharp edge to razor sharp perfection.

SHARPENERS



**NEW**

### Sharpening Stones

Benchtop 2"W x 6"L Diamond Whetstone™ complete with case, rubber non-skid feet.

**DMT W6EP - Extra fine** stone (Green) • .68 lb.

**DMT W6FP - Fine** stone (Red) • .68 lb.

**DMT W6CP - Coarse** stone (Blue) • .68 lb.

**DMT W6XP - Extra coarse** (Black) • .68 lb.



**SharpX Sharpener** Double carbide edge. Finger stop, two handle component, sharpens all kinds of cutting blades  
**BAH SharpX**



**Saw File** For all non-impulse hardened blades  
**ARS AC-9F10** • .1 lb.



98% of all sharpening can be performed by the fine (600) grit diamond. For those who want to get the job done faster and still leave a quality finish use the medium or 400 grit. The coarse grit (250) is for axes, shovels, garden tools or industrial use.



10"x7/16" Fine diamond round shaft with plastic handle. Use for larger nursery knives or Christmas tree knives.

**EZE P - Fine** • 44 oz.

3 3/4"x1/4" Fine diamond pad on 6"x3/4" red plastic handle. With leather pouch with belt loop.

**EZE M - Fine** • 34 oz. with pouch



### Diamond Hone and Stone

3/4"x2" diamond pad on 6"x3/4" red plastic handle. Available in three grits.

**EZE LF - Fine** stone (red) • 6 oz.

**EZE LM - Medium** stone (purple) • 6 oz.

**EZE LC - Coarse** stone (black) • 6 oz.

PROFESSIONAL GRADE PICK-UP TOOL  
for HEAVY DUTY COMMERCIAL USE

# E-Z Reacher PRO

- EZR 20P - 20" length • .58 lb.
- EZR 32P - 32" length • .74 lb.
- EZR 40P - 40" length • .78 lb.
- EZR 60P - 60" length • 1.02 lbs.
- EZR 72P - 72" length • 1.14 lbs.

Replacement cup  
EZR RCC



Ergonomic handle design reduces hand & finger stress, safety locking feature, strong anodized aluminum and stainless steel construction and heavy duty rubber cup grippers!

## Measuring Wheels from ROLATAPE®

### 300S

- All Steel Construction
- 5 digit ratchet counter
- Calibrated wide rubber wheel
- Safety-Glo color
- Insert-and-lock handle
- Wheel stand (not pictured)
- Measures 100,000 ft.
- 3 feet wheel circumference
- 5 year warranty

ROT 32-300S • 5 lbs.

### 400

- All steel construction
- 5 digit steel counter
- 4 foot circumference wheel
- Handles the toughest measuring needs
- Wheel stand
- Wheel brake
- Measure 100,000 ft.
- 5 year warranty

ROT 32-400 • 8 lbs.



Other models available in meters and various sizes



### LA CROSSE HANDHELD ANEMOMETER

Registers maximum and average wind speed. Displays wind chill and temperature in °F or °C. Will show wind speed of .44 mph to 67 mph. Back lit with battery saving auto off. Neck band and battery included.



### LA CROSSE WIRELESS TEMPERATURE STATION



Min/max records for temperature with date/time stamp. Atomic time & date set automatically. Includes 1 remote sensor but can receive up to 3. Wireless outdoor temp. range: -39.8° F to 157.8° F, Indoor temp. range: 32° F to 139.8° F. Transmission range: up to 330'. Batteries not included.

LAC WS-9080U-IT

LAC TX29U-IT - additional sensor

### LA CROSSE WIRELESS RAIN CENTER



Self-emptying rain bucket - empties via internal tilting cups. Measures total rainfall, past 24 hours rainfall, light-heavy rainfall indicator icons, rain alarm. Transmits up to 330'.

LAC WS-9004U-IT



### Clear-Vu Rain Gauge

5" rainfall capacity, 2" opening, mounting bracket, has rainfall chart. 11 7/8"

TAY 2700 • 8 oz.



### Dwyer Wind Meter

Easy to use hand held wind meter. Hold at eye level facing wind. 2 scales.

DWY 63-100011-00

### Orchard Grove Thermometer

Identifies current and minimum temp. Must be side mounted to register. range 10° - 100°F. 13"

TAY 5499 • 5 oz.



### Waterproof LED Flashlight

Waterproof and also shock resistant. It has 7 bright LED bulbs with 3 functions: Low beam, high beam, and flashing beam of light. Uses three AAA batteries (not included). Includes wrist band.

BTB FL3031WS-B

Flashlight • 2.7 oz.



### Soil Sampler

Model EP - Galvanized steel sampler has saw-toothed cutting edge tapered for easy core

removal of up to 10". The cutaway side permits inspection of soil core. Comes with 20 Soil Sampling Bags.

LMC 1055 - 10" depth



### Soil Test Kit

Model EL - A simple test kit for analysis of pH, nitrogen, phosphorus and potassium. Diagrammed instructions and laminated color charts measure each concentration. Contains Garden Guide manual and soil handbook.

LMC 5679 • 6 lbs.





LMC R-5679 - Reagent Refill • 4 lbs.



# PrizeLAWN Spreaders

## Commercial Walk-behind Spreader Units

WALKING/HAND SPREADERS

	<p><b>Bigfoot BF 1SS</b> 100 lb/1.75 cu. ft. capacity. Balanced stainless steel frame features ergonomic handles and a wide stance for stability. Fingertip controls allow "on-the-go" operation of the third port and side deflector without stopping or stooping. Hopper cover included. <b>PSB BF-1-SS • 39 lbs.</b></p>
	<p><b>Bigfoot BF 1T</b> 100 lb/1.75 cu. ft. capacity. Same features as the standard BF 1 but designed for tow-behind applications. Hopper cover included. <b>PSB BF-1-T</b></p>
	<p><b>CBR IVSS</b> 70 lb/1.25 cu. ft. capacity. Ergonomic stainless steel frame, Bigfoot tires and heavier axle. Hopper cover included. <b>PSB CBR-IV-SS</b></p>
	<p><b>NEW</b> <b>MPR 1</b> "Mid-Pro Rotary" - 70+ lb. capacity. All the important functional features of the CBR IVSS at a fraction of the price! 10" pneumatic tires, spring loaded on/off. Epoxy powder coat welded frame. <b>PSB MPR-1</b></p>
<p><b>Side Deflector Kits</b> Stainless deflector prevents product from being thrown past right wheel. <b>PSB 14889-1</b> - For BF models. <b>PSB 15069</b> - For CBR IV model.</p>	



**100 LB. CAPACITY**  
**HIGH VOLUME OUTLET (HVO)**  
**COMMERCIAL BROADCAST SPREADER**  
**Mass Flow Port for mulch, topdress sand, limestone, ice melt & more! Made in the USA**

- Easily converts to apply fertilizer (standard rates)
  - Pattern control system accommodates variations in materials, ground speed, and humidity
  - Additional "heavy left" and "heavy right" pattern adjustment
  - Hi-impact, injection molded polyethylene hopper
  - 1.75 cu. ft. hopper holds up to 100 lbs
  - Self lubricating Nylatron GS gears
  - Nylon 6/6 wheel and axle bearings with grease fittings
  - Stainless steel frame, handles, legs
  - Large 13" diameter, pneumatic tires on rust-proof rims
  - Hopper cover included
- PSB BF-1-HVO • 39 lbs.**



**REVOLUTIONARY!**  
**Quick, easy and effective lawn repairs every time.**

- Creates perforations perfect for seed growth
- Recycles dead grass to protect seed
- Requires minimal effort
- Plants at correct depth in any soil
- Saves you up to 80% on lawn repair costs
- All you need is seed



**Double Grass Stitcher**  
Make larger repairs in half the time. 20" wide.  
**GSS GSD-002 • 11 lbs.**

**Single Grass Stitcher**  
For fast effective lawn repair  
**GSS GSS-001 • 8 lbs.**



**MODEL BG-1**  
Commercial portable broadcast spreader with hand crank. Polyethylene hopper holds 20 lbs., screw cap, side deflector trim control, coverage up to 14'. Very accurate.  
**PSB BG-1 • 5.5 lbs.**



### UNIVERSAL SPREADER

Hand spreader manufactured from HD polyethylene with oscillating agitator and a four blade distributor. Wheel spreads in a fan shape width. Ten point scale for accurate spreading of seed, granulars, herbicide, insecticide and fertilizer. Stainless side shield adjusts for placement of product.  
**SPY 75 • 7 lbs.**

**Discover The Cutting Edge**

**Manufactured & Assembled in the USA**

*Great for clearing under brush & saplings, mowing around trees & under fences and clearing paths & trails*

**MOWERS - GRILLO/TURF TEQ**



**Model 1305 Multi-Use Tractor For Use With Quick Change Attachments**



**NEW**

**TUR 1305PL Plow**  
The 46 inch wide plow is ideal for snow removal and grading/leveling soil and gravel. The Plow angle (left/right) can be easily adjusted from the operator position and its unique design has the capability to allow the blade to oscillate or to be locked into position. The Model 1305PL utilizes

an innovative compression spring trip release. Additional features include a replaceable cutting edge, a fully hydrostatic transmission with forward /reverse and a 13 HP Honda engine. The Plow can also be easily converted into a Power Edger, Power Broom, Power Rake or Brush Cutter for all season use. Plow also sold separately.

**The Grillo Climber Mower 9.21**



*The Climber will go where no other ride-on mower will.*

A 36" rear discharge tuff cut mower with 21 HP Vanguard air cooled engine, front brakes, differential lock, roll bar, hydrostatic transmission, and swing away blades. Extend your mowing into sloping terrain, rough ground and tall grass.



**Design**

The Climber's unique design, with its low center of gravity, central weight distribution, and differential locking capability will help you mow places you can't even take a tractor. Go places you have never gone before and extend your mowing where previously impossible. The Climber is designed to mow safely up and down slopes up to 33° and up to 17° across slopes, even on difficult and slippery terrain.



**Reliability**

The difference with Grillo is that as a family owned business, established on quality, keeping this value in their products is very important. Grillo is Italian and built to last. Their high quality components, top class manufacturing and highly innovative design makes their mower stand out above the rest. Professional equipment that provides great performance.



**Performance**

The Climber is designed for the rough stuff. It will take care of 3' tall grass, weeds and brush. It's capable of flattening an overgrown section, or those properties you can't mow every week, making it a perfect choice for the Christmas tree grower. Non-mulching rear discharge is the secret to this aggressive and effective cutting system. The Climber loses no power as it charges through grass, leaving an even spread of cut grass in its wake



# The Ultimate Tree Mower

A unique mower designed to maintain grass and small brush growth on tree farms, nurseries and blueberry farms

## VENTRAC 3100/3200 with Tree Mower - LQ450

- All Wheel Drive
- Tree Deck 45"
- Hydro Lift
- 3 Cutting Heights - 2 1/4", 3 1/2", 4 3/4"
- Branch Lifters & Tire Covers - Standard
- Rear Engine Design, Less Heat/Noise/Exhaust
- Counter Rotating Blade, Rear Discharge - Leaves Clippings in Middle
- 26" Turning Radius
- Suspended front chains, cuts tall grass more effectively, reduces potential of front discharge
- Single swivel front tire
- Optional weed sprayer listed below



**GAS OR DIESEL ENGINE OPTIONS**



VENTRAC - COMPACT TRACTORS



### VENTRAC 3100/3200 Spraying Unit SPRAY ATTACHMENT SPECIFICATIONS

Tank: 15 gallon polyethylene  
 Pump: 1.4 GPM, 12 volt diaphragm pump  
 Pressure: Manual adjustable bypass  
 Spray Nozzles: Single swivel nozzle bodies mounted one each side of tractor. Adjustable in width and height  
 Controls: Independent nozzle controls right or left  
 Valves: Manual valves  
 Steel Framework: Easily attaches to tractor hitch  
 Tips: Standard, off-center flat fan, other tips available as options.  
 Hand wand with 6' hose included for spot spray treatment.

#### SET Ventrac-12V

All components available separately



Sprayer nozzles are adjustable in width and height



Single swivel adjustable nozzle body with OC tips



### VENTRAC with LC150 Stump Grinder

The LC150 stump grinder features 12 replaceable carbide cutting teeth.  
 Adjustable blade hydraulically lowers to double as a jack stand and depth gauge.  
**AVAILABLE FOR MODELS 3000, 3100 AND 3200**

#### LC150 STUMP GRINDER SPECIFICATIONS

Rotor tip speed: 2,475 ft./min\*  
 Rotor RPM: 620 RPM\*  
 Cutting depth below ground level: 6"

\* Engine speed of 3200 RPM



Ideal for grinding stumps in the tight quarters of a choose and cut operation



## 4200VXD ...PROFESSIONAL GRADE

The 4200VXD Compact Articulating Tractor is professional grade, giving you the ultimate in power, performance and productivity all in one machine. Others can only dream about Ventrac's innovative design of an articulating, oscillating frame, combined with All-Wheel-Drive allowing you to maneuver around obstacles and traverse a variety of terrain.

4200VXD	
<b>Engines</b>	Kawasaki 27 hp Gas 2-cyl 745cc Vanguard 26.5 hp Dsl 3-cyl 952cc Vanguard 31 hp Gas 3-cyl 952cc Vanguard 31 hp Turbo Dsl 3-cyl 952cc (All 4200VXD engines are Liquid-cooled)
<b>Drive</b>	All wheel drive (AWD)
<b>Dimensions</b>	Wheelbase: 43 in. Length: 77 in. Overall Height: 67 in. (to top of rollbar) Width: 49 in. (w/single turf tires) 70 in. (w/dual turf tires)
<b>Turning Radius</b>	43 inches



VENTRAC - COMPACT TRACTORS

**RENTAL AVAILABLE**

**A Full Complement Of Attachments Are Available OVER 40 TO CHOOSE FROM!**

**CALL FOR DETAILS & DEMONSTRATION**

**Get attached - Get it done!**

### VENTRAC MOUNT SYSTEM

This easy-to-use connection gives the operator the advantage of connecting and disconnecting to a variety of Ventrac designed attachments with ease and speed.

- Single lever quick release
- Slide on attachment rails
- Quick and easy PTO connection
- "Quick Couplers" for hydraulic hoses
- Optional dual wheels for 30° continuous side hill operation



### HEAVY METAL (HM) SERIES



### TACKLE THE IMPOSSIBLE!

Get maximum angle of operation with the Ventrac 4200VXD, approved for 30° continuous operation, when equipped with dual wheels.





## LE 3100/3200 ...

### Good things come in small packages

These power-packed units feature all-wheel-drive, power steering, hydrostatic drive, and more. The Ventrac Mount System allows you to change attachments quickly and efficiently, moving from job to job with minimal effort.

Equipped with a patented Tandem Drive train, the 3100 & 3200 efficiently transfers power to where it's needed for unparalleled performance and power.

Also standard on the 3100 & 3200 is Ventrac's patented S.D.L.A. control, which allows for easy command of speed, direction, lift and auxiliary function all with one hand.

Combine these features with a tight 28" turning radius and you will find the 3100 & 3200 can tackle jobs reserved for much larger, less maneuverable machines.



Shown with optional cab

VENTRAC - COMPACT TRACTORS

#### STANDARD FEATURES:

- All wheel drive
- Hydrostatic drive
- Articulating/oscillating frame
- S.D.L.A. controls
- Foot pedal

#### OPTIONAL FEATURES:

- Knobby tires
- Weight transfer (standard on 3200)
- Tilt steering (standard on 3200)
- 12 volt power supply/switch control
- Suspension seat
- Roll bar
- Tractor cab

**3100:** 21HP V-twin air cooled engine, gas **OR** **3200:** 23.6HP Liquid cooled engine,



### Over 20 attachments available

### 4100 ... As Individual As You Are



The Ventrac 4100 is designed and built with the same inherent quality, versatility, safety and control as the 4200VXD. Equipped with a powerful V-Twin 31 HP Air-Cooled engine and driven by Ventrac's high efficiency hydraulic drive system.



	<b>4131</b>
<b>Engine</b>	31 HP Kawasaki Gas (Air-cooled)
<b>Drive</b>	All wheel drive (AWD)
<b>Dimensions</b>	Wheelbase: 43 in. Length: 77 in. Overall Height: 67 in. (to top of rollbar) Width: 48 in. (w/single turf tires) 70 in. (w/dual turf tires)
<b>Turning Radius</b>	43 inches

# FERRI ZMT



## Offset in-line slope mowers For Agriculture and Roadside Tractors from 50 - 80 HP

- ZMT160 — 50-60HP, 5'3" cut width
- ZMT180 — 60-70HP, 5'11" cut width
- ZMT200 — 70-80HP, 6'7" cut width

Ferri offset flails work well for long reach or ditch bank mowing. Flails lift to 90° vertical or down to -50°. Safe and perfectly balanced, these machines allow for careful working even in difficult situations. ME and MT mowers for grass and light brush include adjustable rear roller, internal sealed rotor bearings, double skin and cast iron gear box.

# FERRI ZME

## Offset in-line slope mowers Specifically designed for compact tractors

- ZME125 — 18-30HP, 4'1" cut width
- ZME155 — 25-40HP, 5'1" cut width



# FERRI MT

## Mowers For mowing grass and twigs

- MT140 — 30-45HP, 4'7" cut width
- MT160 — 35-50HP, 5'3" cut width
- MT180 — 45-60HP, 5'11" cut width
- MT200 — 50-70HP, 6'7" cut width



# FERRI ME

## Mowers For mowing grass

- ME125 — 20-25HP, 4'1" cut width
- ME155 — 25-30HP, 5'1" cut width



## Flail Choppers

3 pt. hitch PTO chopper is very heavily constructed complete with: rear roller, belt drive through H.D. gearbox, H.D. 5 lb. flails, adjustable cut height 3/4" - 4 3/4", parallelogram hitch. Brush rake and swinging rotary mower arm optional.

Model	BG-180	KG-220
Cut Width	5'11"	7'3"
Offset from Center	4'10"	6'2"
Min. HP-Grass/Brush	35/45	40/60
Weight-Lbs.	1280	1480

Other widths available. Call for more information.

Parts and service for all Perfect mowers and shredders.  
Call or write for specific information on Perfect equipment.

## OMF-750 SERIES

- Super-duty low profile Flail Chopper
- 2 3/4 lb. hard faced hammers mounted on 3/4" Grade 9 bolts with 1 1/2" mount pads
- 2.4375" spherical roller main bearings
- Double wall housing 3/8 liner under 3/16 skin
- 24" hydraulic offset standard
- Floating top link pad
- Cutting width from 4'-9'
- Heavy duty - 6'-2,154 lbs., 7'-2,350 lbs., 8'-2,550 lbs.
- Options: Push/pull mount

# REARS

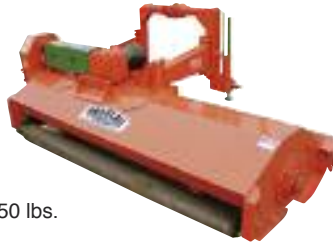

OMF Flail Hanger

The Series 750 OMF flail uses a double row spherical roller bearing with oversize rollers and an eccentric locking collar. This rotor bearing is nested in a labyrinth grease seal.

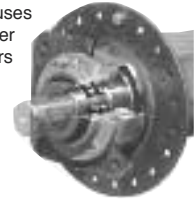

## SPF FLAIL MOWER

- For the lowest horsepower available in tractor restrictive plantings. Ideal for cane, berries, Christmas trees, ski resorts, parks, golf courses, nurseries.
- 3-point mount, centered or offset. 24 to 100 inch cutting widths.
- Options: Low-profile unit. Hydraulic offset. Front mount unit. Push/pull mount. Right hand drive. Narrow vineyard profile
- 0 to 6 inch cutting height.



A B C

- A - left hand drive, fixed right offset
- B - left hand drive, fixed center mount
- C - left hand drive, hydraulic pantograph

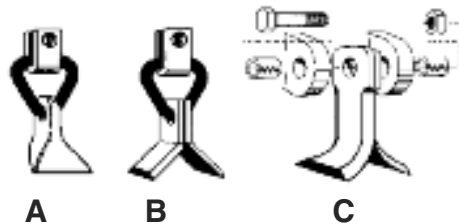

A - FL920 Super-TUF hardened grass blade assembly for a finish cut

B - FL960 shredding knife assembly for a coarse cut in grass and for shredding light brush

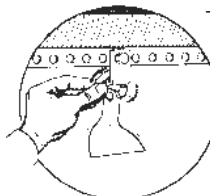

The FL920 and FL960 blade assemblies are easily replaceable without a wrench or socket. Simply turn the D-ring hanger and slip off the blade.

C - FL940 crop chop knife for heavy mowing and brush shredding



## REARS FRONT MOUNT

Run the slopes with Rear's Front Mounted Pak-Flail. Pak-Flail mows grass, eats brush and small trees. Leaves a covering of mulch, an ideal light bedding easily covered by the first snow.

**Call, email or write for specific information on any flail mower.**



**Call about the availability of rebuilt equipment as an economical option to new!**

REARS FLAIL MOWERS



Model	Main Deck Spindles	Min. Tractor HP	Min. Width	Max. Width	Weight (lbs.)
SL2-160-210	2	30	64"	84"	770
SL3-180-230	3	30	72"	92"	814
SL3-200-250	3	40	80"	100"	858
SL3-230-280	3	40	91"	110"	924
SL4-270-320	4	80	108"	128"	1100
SL4-310-380	4	60	122"	142"	1188

Fischer's SL Series orchard mowers are rugged, compact and low profile. They are ideal for low-hanging fruit. The swing arm is available in either mechanical or hydraulic sensing retract. The hydraulic sensing style uses the tractor hydraulics to set the width, then the self contained sensing system moves the arm around even the smallest trees with no damage. All SL models include 30" hydraulic linear side shift.

**SERIES RF ROTARY MOWERS**

3 pt hitch with swing arm. Low construction to clear fruit branches, parallelogram for offset adjustment, front swivel wheels to adjust to terrain, large rear roller, swing arm to cut around tree trunks. Hydraulic offset, swing blades, feeler bar, all optional.



RF-220 3pt w/ Cutting Width 7'3"

**Specifications: Right offset only**

Model	RF-220	RF-300
Cut Width	7'3"	9'10"
Offset from Ctr.	7'1"	8'4"
Min. HP	22	30
Weight-Lbs.	905	1135



**SERIES ZA ROTARY MOWERS**

Trailed rotary mower with swing arm. Trailed from the drawbar on the tractor, these machines are capable of large offset. Two large tires and one swivel support mower to give high quality cutting. Swing arm cuts easily around fruit tree trunks. Lengthways transport feature for large machines.



ZA 300 Rotary w/ Cutting Width 9'10"

**Specifications: Left offset only**

Model	ZA-300	ZA-340	ZA-380
Cut Width	9'10"	11'2"	12'6"
Offset from Ctr.	9'1"	10'10"	11'10"
Min. HP	30	35	40
Weight-Lbs.	1115	1230	1345

**SITREX Finish Mowers**



L Series - Side discharge

**Sitrex three spindle finish mowers.**

- Two versions: rear discharge and side discharge, suitable for parks, golf courses, athletic fields, highway maintenance & farming.
- 12-40HP
- Fully floating 3pt. hitch to obtain best cutting finish, even on undulating ground
- All rear discharge models are fitted with safety chains



P Series - Rear discharge

Model	SM 120 L/P	SM 150 L/P	SM 180 L/P
Cut Width	48"	60"	72"
Cut Height	1"-4"	1"-4"	1"-4"
HP Required	12-20	15-30	20-40



**GL**

Model	Spindles	Min. Tractor HP	Min. Width	Max. Width	Weight (lbs.)
GL4/50-130-215	4	30	51"	85"	660
GL4/60-140-245	4	30	55"	96"	704
GL4/60-180-280	4	40	71"	110"	858
GL4/70-180-300	4	40	71"	118"	891
GL4/80-200-340	4	50	79"	134"	1056
GL4/90-220-380	4	60	87"	150"	1177



The Fischer GL4 features two precision-sensing hydraulically-controlled swing arms, a self-contained hydraulic system and height adjustable rollers, making it an ideal mower for vineyards, tree plantations, nurseries and high-density orchard plantings. The GL4's ability to mow carefully within the row is particularly helpful to growers whose management program does not include the use of herbicide strips. Available in a wide range of sizes.

*Pictured with optional Herbicide Kit.*

ORCHARD/VINEYARD MOWERS



**BV**

The BV2 is a versatile mower for fruit plantings of all types — tree fruit, grapes or berries. The BV2 features a continuously variable hydraulic width adjustment as well as hydraulic side-shift. It is an ideal machine for variable width plantings where the management plan incorporates herbicide strips.

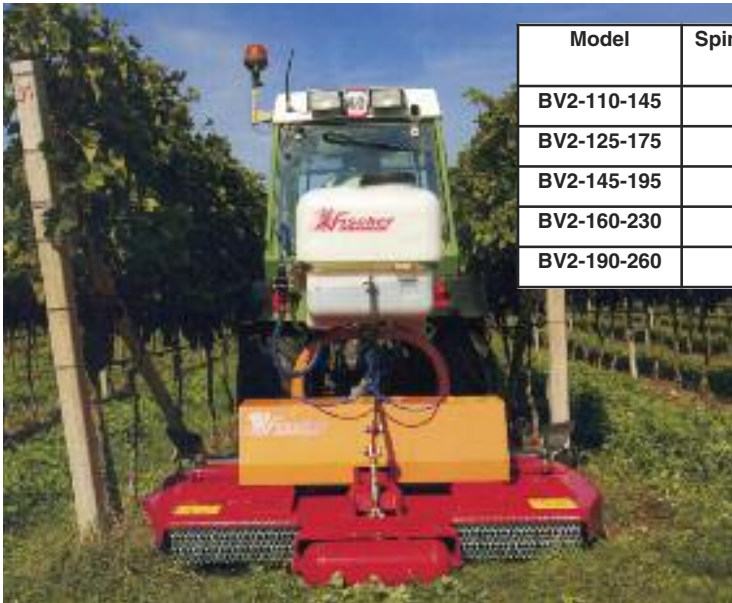

Model	Spindles	Min. Tractor HP	Min. Width	Max. Width	Weight (lbs.)
BV2-110-145	2	30	43"	43"	660
BV2-125-175	2	30	49"	69"	748
BV2-145-195	2	40	57"	77"	863
BV2-160-230	2	40	63"	91"	1078
BV2-190-260	2	50	75"	102"	1232

**Fischer BV2 Features:**

- 3 pt hitch mount
- Hydraulic width adjustment
- Hydraulic side shift
- Three over-sized cast gearboxes
- Heavy duty steel plate deck
- Two counter-rotating blade rotors with four swing-mounted mower blades
- Chain guards, front and rear



*Pictured with optional Herbicide Kit.*



# BUSH HOG®

**"THE ORIGINAL" SQUEALER ROTARY CUTTERS**  
**Our BEST Selling Rotary Mower!**  
**For light mowing on small or large areas**  
**All made in the USA!**



## SQUEALER

**ALL PARTS AVAILABLE!!**



SQ160

- 5 Year Gearbox Limited Warranty
- Pan Type Blade Carrier
- EZ Clean Deck
- Quick Hitch Compatible
- Sidebands With Welded Skids
- EZ Lube Drivelines
- Quick Detach Gearbox Shields
- Bush Hog® Gearboxes
- Powder Coat Paint
- Below Deck Structure
- Rear Band
- Original Bush Hog Design
- Genuine Bush Hog Blades
- Laminated Tail Wheel
- 1" cutting capacity

Single Spindle Models	Squealer 142	Squealer 148	Squealer 160	Squealer 172	Squealer 184
Cut Width	42"	48"	60"	72"	84"
PTO HP required	10-25	15-20	25-40	35-45	Min. 50



SQ84T

### SQ84T SQUEALER

**with Twin Gearboxes and 9-inch offset**

The SQ84T comes in a 7-foot cutting width for tractors from 35 to 50 PTO horsepower. Reliable and durable, this model has everything that made Bush Hog famous.

BUSH HOG - ROTARY MOWERS



296

### 290 SERIES Your BEST choice for medium duty cutting

- Cuts materials to 2"
- Extra deep 1/4" side bands
- Full length strongback
- EZ clean sloped 10 ga. decks
- 130 HP Bush Hog® gearbox
- Replaceable full length skids
- Slip clutch standard

	295	296	297
Cut Width	5'	6'	7'
Min. HP required	35 HP	45 HP	55 HP



326

### 320 SERIES Your BEST choice for heavy duty cutting

- Cuts materials to 3 1/2"
- Deep sidebands handle heavy volume
- Extra heavy duty hitch & tailwheel assembly and wheel bracket
- Fabricated 7 ga. decks
- 1/4" Sidebands
- Deck reinforcements
- Blade pans
- Cat. 5 driveline

	325	326	327
Cut Width	5'	6'	7'
Min. HP required	40 HP	50 HP	60 HP (lift) 40 HP (pull)



406

### 406 SERIES One of the toughest cutters on the market!

The 406 is a heavy-duty mower for brush cutting, land clearing, rights-of-way and highway maintenance. Minimum tractor HP - 60 PTO

- Cuts Material Up To 4 Inches
- Heavy Reinforced Deck
- Made For Heavy Brush Clearing
- Extra Heavy Blades
- Front Safety Chains Standard
- Fabricated 1/4 Inch Thick Deck
- 1/4 Inch Sidebands
- 3 Inch x 1 1/2 Inch x 1/4 Inch Channel Strongbacks
- Heavy Duty A Frame And Tail Wheel Bracket
- Extra Heavy Duty Blade Pan
- Extra Heavy Duty Bush Hog Blades
- Powder Coat Paint
- 6' Cut Width

**pillon**

OESCO now offers the Pillon line of fruit harvesting platforms. These platforms are self propelled, diesel powered with hydraulic movements for the elevation, width and leveling of the platform. They are year round, multiple use machines, equipped with air compressors for pruning. Other uses include: thinning, trellis work and net installation.

Designed for efficiency, they pick up empty bins with the front lift and gently lower the full bins with the rear lift.

Information needed to place an order: row spacing, type of planting (semi-dwarf, dwarf on trellis, tall spindles on trellis), bin sizes, and number of pickers normally used.

*We are very enthusiastic about this Italian picking platform!*

**NEW**

Options:

Free wheel device for towing

Remote control

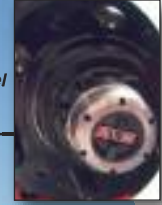

These machines are built to order, offering you the opportunity to customize the unit exactly as you want it. Call to discuss your needs and receive a quote.

PLATFORMS/TRANSPORTERS/DUMPERS



## Transporters and Dumpers

Dump box with 3 expandable side boards for large loading platform with hydraulic lift.



**BRT BTR-500-HY**



Hydraulic dump body with 50 gallon, 1100# capacity.

**BRT BTR-500D**



### SPECIFICATIONS

Engine	Honda GX160, 5.5 hp recoil start gasoline engine
Clutch	Belt driven with automatic disengagement when control lever is released
Transmission	3 forward gears and 1 reverse Mechanical – gears in oil
Speed	Speed forward 1st, .9mph; 2nd, 2mph; 3rd, 3.3mph; Reverse, .9mph
Steering	Independently controlled 28" radius minimum
Brakes	Expansion type, with automatic engagement at clutch disengagement
Ground Clearance	2.8" minimum at gearbox
Crawler Track Contact with Ground	24" long x 7" wide, 25" track width
Platform Body	Adjustable side boards 40" – 48" long
<b>BRT-500-HY</b>	Adjustable side boards 26" – 44" wide
	Capacity 1100 lbs., 50 degree tilt average hydraulic dump
Gravel Body	24" wide capacity 50 gallons
<b>BRT-500-D</b>	1100 lbs. hydraulic dump, 60 degree tilt average
Weight of Machine	450 lbs.
Operation	20 degree slope with load, 40 degrees without load
PTO/Hydraulic	2100 rpm / .6 gpm hydraulic flow



Technology as a passion.

# Powerful Articulated Tractor Series for the most demanding farmers and woodlot owners

Tight turning & maneuverability between rows or in woodlots

GOLDONI TRACTORS



## CLUSTER 70 SN

**NEW**

The Cluster 70 SN is the powerhouse of the Goldoni Articulated Tractor Series. With a 66 HP water cooled VM diesel engine, and a 3500 lb. 3 pt. hitch lift capacity, the Cluster will out perform other tractors of the same size. The 47" minimum width lets you go where no other tractor of this horsepower will.



## EURO 45 SN

**NEW**

The mid-sized Euro W45SN is a powerful, compact, yet stable tractor capable of working well on slopes. With a 38 HP water cooled Lombardini diesel engine, low center of gravity and working widths from 40" to 52", this tractor can handle many of your toughest jobs in tight spaces with ease.



**NEW**

## BASE 20

The Base 20 is the most compact tractor of the Goldoni Articulated Tractor Series. With a width of just 32", this tractor will go where no others will. A 21 HP air cooled Lombardini diesel engine, 6 forward speeds and narrow profile make this the perfect tractor for mowing, tilling and cultivating in tight plantings.

*Goldoni conventional tractors are available by special order.*



## Premium Walk Behind 2-Wheel Tractors



**NEW**

## JOKER 12S

The Joker 12S uses a cast gearbox and Honda 9 HP recoil start engine for durability and long service life. With 4 forward gears and reversible handles, the Joker can utilize other front mount attachments, but comes standard with their 27" adjustable tiller.



**NEW**

## TWIST 6

The Goldoni Twist 6 has a Honda 5.5 HP recoil start engine, 22" tiller box and 4 forward speeds to give big performance in a small package.

## The Ultimate Trail and Farm Machine

The Goldoni Transcar is a powerful, versatile and compact off road workhorse. With articulated steering and a 3500 lb. load capacity, the Transcar will make small work of your biggest jobs. From trails to construction sites to horse farms, the Goldoni Transcar does it all.



**RENTAL  
AVAILABLE**



GOLDONI TRANSCAR

### Transcar W33SN "Syncro"

- Engine: Lombardini 2-cylinder diesel LDW1503 475kw, 33 HP, water cooled
- Transmission: Manual shift, synchronized with 8 speeds forward and 4 reverse
- Hydraulic service brake, double circuit acting on all four wheels
- Mechanical parking brake, acting on the rear wheels
- Power steering - articulated
- Rear standard 540 PTO
- ROPS approved rollover protection with seat belt
- Trilateral hydraulic dumping through a 4 stage sliding cylinder
- Tires: 10.0/75 x 15.3 ag tires, turf tires optional
- Body: 89"L x 59"W x 14"H

**Our #1 Seller!**

### Transcar W40SN "Syncro"

- Lombardini LDW 1603 three cylinder diesel engine, 36.2 HP, water cooled
- Tires: 10.0/75 x 15.3 ag tires, also available with turf tires
- 16 speed synchronized transmission, 8 forward and 8 reverse with reverser
- 4 WD with rear wheel mechanical disengagement
- Differential lock—both axles—hydraulically operated
- Hydraulic brakes, double circuit, acting on all four wheels
- Hydrostatic steering—articulated
- Rear PTO—standard at 540 rpm, clockwise rotation
- Trilateral hydraulic dumping through a 5 stage sliding cylinder
- ROPS approved rollover protection with seat belt
- Body: 94"L x 59"W x 16"H



**3-Way Dump: Right, Left and Back**



**Other models  
available by  
special order**



# TrakMats™

**RENTAL AVAILABLE**

Use with all kinds of vehicles (no steel tracks)



**STRONG FLEXIBLE EASY-TO-USE**

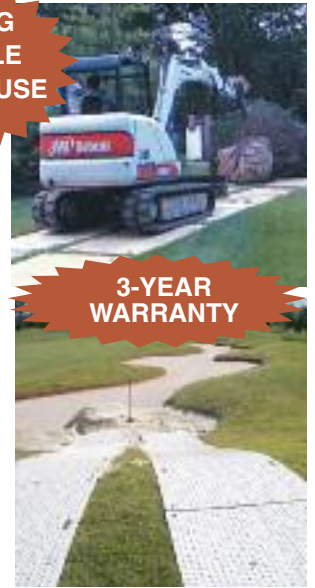

**3-YEAR WARRANTY**



NURSERY CARTS/TRAKMATS

**NO RUTS  
NO DAMAGED LAWN OR GROUNDS  
NO WEATHER DELAYS  
NO MORE DAMAGED PLYWOOD  
3 Year Warranty!**

TrakMats is a 1/2" thick polyethylene mat made from 100% recycled material used to support heavy equipment on grounds or turf. Polyethylene is very flexible and will hold up to 60,000 pounds. **No more ruts, damaged lawn or weather delays!**

The mats are UV protected and not affected by hot or cold. The light colored mats stay cool and are manufactured in convenient sizes to fit the job. We recommend the width of the mat should be at least 1/3 wider than the widest tire on the vehicle. That gives the driver a mat size they can stay on so the load can be distributed to the ground. Hand cutouts are provided to assist lifting the mat.

TrakMats will not absorb water, will not dry rot and are not affected by oil, gas, or other chemicals. No more heavy, wet, rotten, broken, slippery plywood! Guaranteed against cracking and breaking for 3 years from date of purchase. To clean, simply wash with water.



**YOU NEED A MAT SYSTEM TOUGH ENOUGH TO DO THE JOB ...**

**LIGHT:**

- TRA TM2248** - 22 1/2" x 4' x 1/2" • 19 lbs.
- TRA TM2272** - 22 1/4" x 6' x 1/2" • 29 lbs.
- TRA TM2296** - 22 1/4" x 8' x 1/2" • 39 lbs.
- TRA TM3696** - 36" x 8' x 1/2" • 64 lbs.
- TRA TM4496** - 44 1/2" x 8' x 1/2" • 78 lbs.



**BLACK (for use in mud conditions or where damage to lawns is not a concern):**

- TRA TM2248B** - 22 1/2" x 4' x 1/2" • 19 lbs.
- TRA TM2272B** - 22 1/4" x 6' x 1/2" • 29 lbs.
- TRA TM2296B** - 22 1/4" x 8' x 1/2" • 39 lbs.
- TRA TM3696B** - 36" x 8' x 1/2" • 64 lbs.
- TRA TM4496B** - 44 1/2" x 8' x 1/2" • 78 lbs.

## W.W. Manufacturing Company, Inc.

### TRACKING WAGONS (TRAILERS)

Standard sizes available: 4'x8' (WWM 87), 5'x8' (WWM 90), 4'x10' (WWM 88), 5'x10' (WWM 91), 5'x12' (WWM 92) and 6'x12' (WWM 93) Other sizes special order. Freight only.



- Drawbar with Clevis hitch (folds for storage)
- Expanded metal deck
- Front axle parking brake applied when drawbar is raised/stored
- Heavy steel construction with angle iron
- Rear hitch for next wagon drawbar
- Both axles steer
- High speed wheels, bearings, hubs and axle pivot points.

To order: Call for quotation. Options include multiple decks.

### GO FOR CART

Large H.D. deck 27"x60", deck cover expanded metal, deck height 20", two swivel pneumatic wheels front, 2-16" fixed pneumatic wheels rear. Carrying capacity 600 lbs. **WWM 78**



### Tree/Ball Carts

Heavy duty welded steel tube standard with wide floatation tires, two sizes 24" and 36" ball size. Truck freight only.

24" ball 25" frame width, 29" overall 1" axle, 16x6.5x8 tires, 1000# cap. **WWM 224F**

36" ball 30" frame width, 38" overall, 1" axle, 16x6.5x8 tires, 1000# cap. **WWM 230F**



### SERVICE CARTS (WAGONS)

Heavy duty carts for garden centers or nurseries. 600 lb. capacity. Pneumatic tires, expanded metal deck, 4" high railing. Two sizes.

**WWM 81 - 28"x48" deck**  
**WWM 82 - 24"x36" deck**



**Pack-It Tree/Goods Carrier**

**BAR B3-4C** - 68" x 68", 2-4 person carrier • 6.25 lbs.

**BAR B7-BW** - 49", 2 person carrier • 2.8 lbs.



**Model RI**  
A tough versatile landscape rake for Category 1 or 2 tractors, 35 HP and up

**Quick Hitch Compatible!**



**NEW**

Max. Raking Width	6' - 10'
HP Rating	35 HP and up
Hitch	Cat. 1 or Cat. 2 3 pt. or quick
Caster Wheels	Optional, Pneumatic (6")
Cutting Edge	Optional, Replaceable Cutting Edge
End Boots	Optional
Scarifier	Optional, 10 heat treated, reversible, alloy steel points, 72" wide



**Model FM**  
Put a front mount rake in place of your snowplow!

**NEW**



MODEL	007518	007528	007538	007548	007568
Fits Hitch (Snowplow)	Fisher	Western	Diamond	Meyers	Boss
Max. Raking Width w/extension down: 11'					
Max. Raking Width w/extension up: 90"					
Caster Wheels	Standard, 13/6.50 x 6 Pneumatic tires with high speed bearings				



**BUSH HOG®**

Call for information on all these Bush Hog items



2103

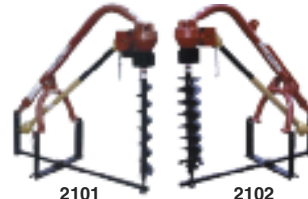

2101



2102

**2100 Series Post Hole Diggers**

Three models available. Cat 1 or 2 mounting, 48" digging depth, 6"-24" augers.



**MBX Series Box Rakes**

60" - 96" widths



**35 Series Blade**

Available in 4, 5, 6 and 7 foot operating widths.



**LLR & MLR Series Rear Rakes**

Light and medium Duty

60" - 90" widths. For tractors up to 50 HP.



**70 Series Blade**

Available in 6, 7, and 8 foot operating widths.



**BUSH HOG Front end loaders.**  
Available in factory colors



**BUSH HOG Backhoes are available in tractor factory colors**



**Worksaver™**

**Clear more brush!**

Worksaver Grapples designed for tractors that are equipped with a front loader. 2 sizes available.

## Maschio Rotary Tillers

The Maschio Rotary Tillers have provided a strong reliable tool for over 40 years to the agricultural market. Available in a wide variety of sizes. Contact us for details.

*Other models available to 10' widths*



**NEW**

**W Series**  
41"-52" width

Single speed, chain drive, adjustable offset mast



**NEW**

**H Series**  
65"-81" width

Single speed, chain drive, fixed mast



**NEW**

**U Series**  
63"-93" width

4 speed, gear drive, fixed mast

LAND PREPARATION

## REARS PAK Fork

The "All-Around-Farm-Tool"

- Constructed from 2"x4" rectangular tubing
- 3 pt. hitch Cat. 1
- Transport fork
- Hooks up FAST
- 26" wide
- 44" load length
- Weight: 98 lbs.- truck freight
- 1000 lb. capacity

**BEST SELLER!**



Use it to haul pallets of fencing, fence posts, hay and feed. Transport tote boxes of fruit and vegetables. Move irrigation pumps and small buildings. The list goes on and on ... that's why it's called the "All-Around-Farm-Tool!"  
**REA PAKFORK**



- Expand machine usage
- No hardware or chains needed
- Adjustable tine spacing
- Attaches in seconds
- 7 sizes
- 2,500-22,000 lb. capacity

CTI produces forks which adapt to the loader bucket of a farm tractor, backhoe or industrial loader eliminating the need for a separate forklift. These forks are solid steel attached by welding brackets to the bucket top lip. A connecting bar holds the tines and when the bucket is rolled back, the forks are attached. The tines adjust, no hardware or chains are necessary - and they attach in seconds! Call for more information. See price list for models.



## REARS PAK-STAK

Hydraulic fork lift attachment. Available in 3 pt. hitch or subframe mount. 84" - 94" lift height. Fixed or hydraulic tilt.  
**REA PAK-STAK**

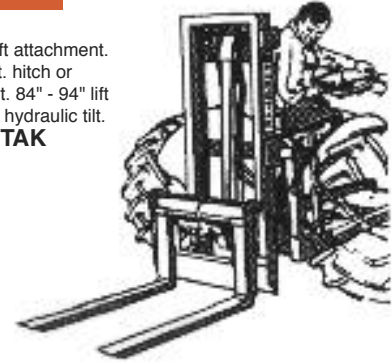

**Clamp-On Bucket Forks -**  
Models BF-1000, BF-2000, BF-3000, BF-4000, and BF-6000



Available in 5 models from 1,000 to 6,000 lb. capacity. Mounts in seconds without tools, equipped with handles for easy mounting, adjustable handles and safety rated at twice the capacity.



**TT4800 and TT4900 Universal Lifts**

- Designed for easy on-off
- Convenient operation to any Cat. 1 or 2 three-point hitch tractor
- Top link adjustable 22" - 28"

### 3-point TRANS-PORTER

Cat. 1, 3 pt. hitch. Low cost carrying device designed to lift bulk bins, feed, baled hay - almost anything including other implements.

- Lifting height - up to 16"
- 46" solid steel forks
- Tilts 10° at maximum lift height

**EDW TP6412** - 1500 lb. capacity



For more models and detailed information please contact us.



## SPIN GROOMER

Conditions and levels arena surfaces. Spins as you pull it. Levels at the edges. 4 sizes: 5-8 foot diameters. Adjustable with just one moving part. Bolt on hardened tines.



With attachable rake



## BLIZZARD



Agricultural Snowblowers

48"-94" width, for 15-75 HP tractors. Manual or hydraulic rotation.

**Contact us for details and options**





**ACCURATE AND PRECISE**

**EUROPEAN MANUFACTURED VICON SPREADERS**

Super Flow spreaders from Vicon fulfill all requirements for a long service life. The glass fiber reinforced polyester hopper and stainless steel meter disc is unaffected by aggressive types of fertilizer. The spreading unit and frame use the unique Duracoat Powder painting system for exceptional corrosion resistance. The bearings of the spreading unit have easily accessible grease fittings for maximum ease of maintenance.



The spreader is shipped with one standard broadcast spout. Many spout options are available for banding and narrow spread patterns. Call for options like covers, agitators, and hydraulic controls.

Specifications	203	303	403	503	604	754	804	954
Hopper lbs.	400	600	950	1200	1400	1650	1900	2100
Cu. Ft.	5.9	8.9	14.1	17.6	21.2	26.5	28.2	33.5
B.U.	4.7	7.1	11.2	14.0	16.9	21.2	22.5	26.8
Filling Height	30"	36"	35"	40"	38"	38"	42"	42"
Spreading Width	3'-46"	3'-66"	3'-66"	3'-46"	3'-46"	3'-60"	3'-60"	3'-60"
Machine lbs.	163	176	267	278	320	335	344	351

**Vicon Máquinas Agrícolas Ltda.**

Manufactured in South America. Heavy fiberglass hopper with (non-adjustable pendulum), spreads up to 39' wide.

Optional spouts available.

It is important to know that this is **NOT** the same spreader as the European Vicon Spreader. Options and parts are different.

**The Economical Option**



Models and capacities. Shipped with standard spout.

Model Number	Capacity	Weight Empty	Width X Height
VMA PS 303	660 lbs.	187 lbs.	3.4' x 3'
VMA PS 403S	880 lbs.	240 lbs.	4.7' x 3.2'
VMA PS 503S	1,100 lbs.	253 lbs.	4.7' x 3.6'



3 PT. AND PULL SPREADERS

**NEW sitrex SPREADERS**  
2 Pull Models available



FSP 100



FSP 150

Spreaders for green areas and garden use. The FSP series spreaders are designed to be used on small tractors, utility vehicles and ATV's without PTO shaft. These spreaders can be used for spreading fertilizers, sand or salt depending on the needs of the user.

Model	Hopper cap.	Max. load cap.	Width of spread pattern	Overall height	Hopper width
SIT FSP-100	26.5 gallons	264 lbs.	2.2-6.5 yards	40"	32"
SIT FSP-150	38 gallons	352 lbs.	2.2-6.5 yards	42"	36"

# Crop Care™

## Row Mulchers

By



### Unsurpassed Mulching Versatility

The Crop Care™ Row Mulcher by Lanco lets you apply mulch in a wide range of applications. You can apply a pattern that is up to 48" wide and 1/2" deep, or 12" wide and 8" or more deep, depending on material conditions and travel speeds.



ROW MULCHERS/ SPREADERS



Model LS-1450

- 5.4 yards, heaped - 6000 lb. cap.
- 30 HP tractor required
- 96" Hopper length
- 36" Hopper width
- Fully adjustable tilting conveyor
- Dual directional delivery system
- Mulch from both sides
- Body: 12 gauge galvanized steel



Cross beam supports. Poly lumber deck has a 10 year warranty. Allows almost any kind of material.

#### Standard features:

- 2-way conveyor
- PTO Hydraulic drive
- Fine chain
- Manual endgate

**RENTAL AVAILABLE**



Tilt control dual directional belt

Other models and capacities available

**NEW**

## 5-in-1 SUPER SPREADER

Other options available

INTERCHANGEABLE SPREADER ATTACHMENTS

The Lanco 5-in-1 Super Spreader is a state of the art spreading machine for spreading many kinds of material. The 5-in-1 features interchangeable spreader attachments, 2.4 yd. (65 ft.) capacity, drive via tractor Hyd (requires 8 GPM), net weight 2,300 lbs., maximum payload 8,300 lbs., W 67" x H 70", Length 157", Apron Chain with 3-1/2" slat opening spacing, rack and pinion end gate, and agricultural rib tire (11L x 15, 8 ply)



LCO BT01	Beater Attachment - For straw manure
LCO BR01	Brush Attachment - For top dressing turf (sand or mulch)
LCO CC01	Cross Conveyor (L or R) Crescent Belt - For row mulching
LCO CC30	Cross Conveyor Dual (L & R) w/2 CC20 Deflector Kit - Used for row mulching (L and R at the time)
LCO DD01	Dual Disc Attachment - Used for fertilizers and compost



# TRAILERS JMS INC.



JMS is a full line log loader company. From the 900 TR (ATV and compact tractors), up to 21' / 3000# lift capacity with tandem axle/walking beam woods trailers, or D.O.T. flat bed and dump trailers. They all feature a double pinion "turn house" and telescoping stabilizers.

*Optional engine powered hydraulic packages available for all models.*



**Call to discuss size, price, and options, for a machine that's right for you.**

JMS / ACCESSORIES



80" Choker Chain Assembly, 5/16" x 80" L  
**WAL 5167G70A** • 8.1 lbs.



Choker Hook  
**WAL 31316228** • .78 lbs.

Glider  
**WAL 31336221** • 1.5 lbs.



Pulley Block  
**TAJ 4T-SB**



Tire chains of all sizes & descriptions available!  
Call for information.

**Contact us or visit our website for more details about these products.**



## RCA 380 FIREWOOD PROCESSOR



The Firewood Processor RCA 380 enables cutting logs of a diameter up to 15" and the splitting of sawed logs in lengths from 8" to 20". With the help of the log loader DM 1511, the logs are loaded to the infeed conveyor and forwarded to the length limiter to be cut. The cut log falls into the splitting chute where it is pushed against the 2 or 4 way splitting wedge (6 and 8 way splitting wedge optional) by the splitting cylinder with 150 kN force.

The splitting wedges are easy to adjust in order to suit the size of the cut log. The firewood is discharged through the 13' conveyor.



*The comfortable  
joy stick control  
operates with  
one hand!*

## RCA 400 JOY



The largest firewood processor Tajfun makes!

16" diameter!



The RCA 400 JOY is the largest capacity (16" diameter) firewood processor that Tajfun makes.

The comfortable joy stick control operates with one hand; log feed (in and out), log cut off, log split and wedge adjustment. With

the other hand the operator can run the log lifter, drink a cup of coffee, or change the speed of the discharge conveyor.

The RCA 400 JOY requires a 12 volt, 30 amps feed from the tractor to operate the electro hydraulic controls and oil cooler fan.

Like the RCA 380, the log lifter has a maximum capacity of one thousand pounds and can handle lengths up to twenty feet.

The RCA 400 JOY also features a hydraulic log clamp, and a hydraulically operated clutch for the saw chain, so that it does not run all the time. This lowers consumption of bar and chain oil.

Contact us or visit our website for more details about these Firewood Processors.

**NEW**



**TAJ RN-3000** - The LIVE DECK RN 3000 increases the capacity of your firewood processor.



**Accessories for your processor**



**TAJ XE-10** - Sawdust Extractor Fan



**NEW**

**Tajfun has introduced this new series of winches in response to user's suggestions over the years.**

Standard equipment includes: 200' of swaged cable, three sliders, parallel hook, high and low pulleys, chain saw holder, fold down brush screen and PV or Pickaroon holder, tool boxes on EGV45 and up.

The models ending in **A**, are all "rope pull" actuated and very easy to use.

The models ending in **AHK** have a self contained hydraulic system which actuates the clutch and brake. The cable drum is still powered by the tractor PTO. These winches also require a 12V power supply from the tractor.

Instead of ropes the winch is equipped with a control pendant that can easily reach the driver's seat or either side of the tractor for ease of control and visibility. The AHK system can also be fitted with an optional radio remote control and/or power off spooling (both options great when working alone).

\* Available on AHK models by special order:  
Radio control and power off spooling



PROCESSOR ACCESSORIES/WINCHES

TYPE	EGV 35	EGV45A EGV 45 AHK*	EGV55A EGV 55 AHK*	EGV65A EGV 65 AHK*	EGV85A EGV 85 AHK*
<b>Pulling Power</b>	7,900 lbs.	10,000 lbs.	12,250 lbs.	14,500 lbs.	19,000 lbs.
<b>Brake Power</b>	9,900 lbs.	12,500 lbs.	15,500 lbs.	18,000 lbs.	23,500 lbs.
<b>Gear Ratio</b>	01:07.5	01:08.9	01:08.9	01:10.8	01:10.7
<b>Rope Velocity</b>	200-390 ft./min.	177-354 ft./min.	177-350 ft./min.	164-325 ft./min.	167-360 ft./min.
<b>Max. Drum Capacity</b>	7/16" / 157 ft. 3/8" / 213 ft.	9/16" / 131 ft. 7/16" / 230 ft.	9/16" / 131 ft. 7/16" / 230 ft.	9/16" / 220 ft. 5/8" / 167 ft.	5/8" / 127 ft. 9/16" / 279 ft.
<b>Min. Tractor Capacity Required</b>	20-30 HP	24-47 HP	40-54 HP	54-90 HP	75-120 HP
<b>Width</b>	48"	55"	59"	65"	71"

# SPLITTERS & GRAPPLES

## 20 Ton - BHH2003 Horizontal Log Splitter

- 20 ton splitting force
- 12 second cycle time
- 5.5 HP engine

IAO BHH2003



## 22 Ton - BHVH-2209/GX Vertical/Horizontal Log Splitter

- 22 ton splitting force
- 12 second cycle time
- 5 HP engine

IAO BHVH-2209/GX



Vertical position



Horizontal position

Made in the U.S.A.

## 30 Ton - BHH3003/GX Horizontal Log Splitter

- 30 ton splitting force
- 15 second cycle time
- 8 HP engine

IAO BHH3003/GX

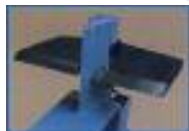
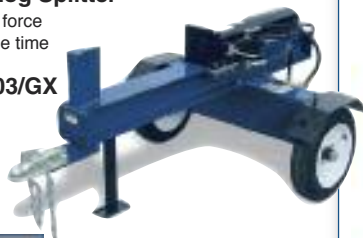

### Four-Way Wedge Kit

(Optional) Available for BHH2003 and BHH3003/GX  
IAO 4-WAY

## WALLENSTEIN

### WLL WX930 48" Splitter

- Powered by 9HP Honda engine
- 2-stage hydraulic pump
- Accepts 4-way wedge
- New wider shelves
- 25 ton splitting force

*Wallenstein Wood Splitters are available upon request*



### Log Skidder 3-Point Tractor Hitch - Model SB-05

Grapple attachment for utility sized tractors in the 20 - 60 HP range (pictured)

IAO SB-05

### Skidder-Loader Skid Steer Mount - Model SL-06

Quick connect grapple attachment for skid steer loaders in the 30 - 60 HP range (not pictured)

IAO SL-06

### Clear more brush!

Worksaver Grapples designed for tractors that are equipped with a front loader. 2 sizes available.



### WLL WX330 48" Horizontal Splitter

- 3 pt hitch mount
- 120" length x 30" width x 18" height
- 20 ton splitting force
- Run from tractor hydraulics

## WALLENSTEIN

# WOOD CHIPPERS

- Approximately 7HP required per inch of round wood.
- PTO Direct Drive with Shearbolt
- Twig Breakers and Air Vents are standard
- 360° Discharge Hood Rotation
- 540 or 1000 RPM input
- Manual or Hydraulic Feed
- I-Match and Quick Hitch
- Reversible Hardened Steel Rotor Knives



Available in orange, blue, green and red (BX92 in Cat yellow)

MODEL	BX32	BX42	BX62	BX92
Chipper Capacity	3" Dia.	4" Dia.-10" slab	6" Dia. - 12" slab	10" Dia. - 15" slab
Rotor Size	17 1/2" Dia.	25" Dia. - 4 paddles	30" Dia. - 4 paddles	30" Dia. - 4 paddles
Rotor Weight	45 lbs.	74 lbs.	197 lbs.	280 lbs.
#of Rotor Knives	2 offset	4	4	4
Recommended PTO	12-30 HP	18-50 HP	30 - 100 HP	65 - 150 HP
Mounting System	Cat 1 - 3 PH		Cat 1 or 2 - 3PH	Cat 2 - 3PH
Dimensions	36"W x 54"L x 60"H	42"W x 40"L x 60"H	52"W x 50"L x 74"H	50"W x 50"L x 90"H
Hopper Opening	12 1/2" x 11 1/2"	20" x 20"	25" x 25"	25" x 25"
Chipper Housing Opening	3" x 6"	4" x 10"	6 1/2" x 12"	
Discharge Hood Height	58"	60"	74"	90"

SPLITTERS/GRAPPLES/CHIPPERS



**DELTA**

DELTA Flexible Harrow is an economical option for smoothing up those logging roads and woods trails. Pull with a tractor, ATV, UTV or draft animals. An excellent choice for creating wild life "food plots" or use in the home garden. After scarifying, simply turn over to gently cover seeds. Available in 4, 6, and 8 foot widths. Stores easily on the side of the barn. Call for info and prices.

**LOGRITE ARCHES**

LogRite Arches are perfect for moving logs of all sizes with minimal impact on the land. Arches for: Arborists, Portable Sawmill Owners, Forest Land Owners

**JUNIOR ARCH**

- Log Capacity 16" diameter
- Weight Capacity 1000 lbs.
- Weight - 66 lbs.

**LOG JA016**

Extension handle available

**LOG JA036**



**ATV ARCH**

- Log Capacity 26" diameter
- Weight Capacity 2000 lbs.
- Weight - 265 lbs.

**LOG AA024**



**TRACTOR ARCH**

**2 MODELS AVAILABLE**

**TA030**

- Log Capacity 30" diameter
- Weight Capacity 4000 lbs.
- Weight - 515 lbs.

**LOG TA030**

**TA036**

- Log Capacity 36" diameter
- Weight Capacity 6000 lbs.
- Weight - 515 lbs.

**LOG TA036**



**NEW SHAPER**  
Manufacturing Co., LLC

Tough jobs made easy with Shaver post drivers. Fast and powerful, rugged and reliable. Shaver post drivers are built heavier than the job requires. With only 6 moving parts, the machines perform for years without a breakdown. You can choose from five models. All models take just a few minutes to mount or detach. All work with any 3-point hitch. Shaver post drivers can be mounted on tractors or skid steer loaders.



**Economy Tongs ...**

**GPM Skidding Tongs**

Swivel grab skidding tongs  
3/8" steel tongs, 2 1/2"-17 1/2" opening, fine ground points for long lasting sharpness.

**GPM 143995** • 9 lbs.

**Steel skidding tongs**

3/4" high carbon steel tongs.  
4 1/2"-25" opening. Heavy duty.

**GPM 19795** • 14 lbs.

5 1/2" - 32" opening

**GPM 19796** • 20 lbs.

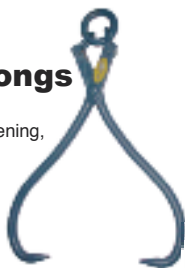

**BAHCO**

**Steel Tongs**

Solid forged steel tongs with thermoplastic rubber handles

**BAH 1401** - 8" length • 2 lbs.

**BAH 1423** - 11" length • 2.1 lbs.

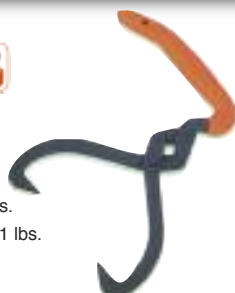

**Top Quality Peavey Skidding Tongs ...**

These tongs are beefed up in the areas where there is likely to be the greatest stress. They are ideal for handling poles and logs.

**Standard Ring**

**PEA R-003-016-0685** - 3/4"x16"

**PEA R-007-020-0687** - 1"x20"

**PEA R-007-025-0687** - 1"x25"

**PEA R-011-032-0689** - 1 1/4"x32"

**Swivel Ring**

**PEA R-003-016-0693** - 3/4"x16"

**PEA R-007-020-0695** - 1"x20"

**PEA R-007-025-0695** - 1"x25"

**PEA R-011-032-0697** - 1 1/4"x32"



WOODLOT

### Cant Hook

The blue handle is easy to see around a woodlot or sawmill. The heat-treated, zinc plated hook is strong and built to last. Handles available in five different lengths with a cant hook style tip. The rubber grip makes the tool easier to hold.

- LOG CH024** - 24" grips 8" to 32" logs • 8 lbs.
- LOG CH030** - 30" grips 8" to 32" logs • 8 lbs.
- LOG CH042** - 42" grips 8" to 32" logs • 9 lbs.
- LOG CH048** - 48" grips 8" to 32" logs • 9 lbs.
- LOG CH060** - 60" grips 10" to 36" logs • 10 lbs.

### Peavey

(patent pending) The peavey uses the same blue aluminum handle and the same heat-treated, zinc plated hook. Handles available in four different lengths. The tip is a point (peavey style). Its light weight makes logs a breeze to move about the work area.

- LOG PV030** - 30" grips 8" to 32" logs • 8 lbs.
- LOG PV042** - 42" grips 8" to 32" logs • 8 lbs.
- LOG PV048** - 48" grips 8" to 32" logs • 9 lbs.
- LOG PV060** - 60" grips 10" to 36" logs • 10 lbs.

### Hookaroon

Heat treated, zinc plates steel tip, rubber grips

- LOG HR024** - 24" • 3 lbs.
- LOG HR030** - 30" • 3.5 lbs.
- LOG HR036** - 36" • 4.5 lbs.

### Log Carrier

(Patent Pending)  
The log carrier is lightweight and strong. The 54 in. handle gives each person plenty of leverage.

- LOG LC054** - Log Carrier • 10 lbs.

### Mill Special Cant Hooks

Smaller diameter handle. No rubber grip. Hand slides easily.

- LOG MS024** - 24" • 8 lbs.
- LOG MS030** - 30" • 8 lbs.

### Forest Pruning Saws

For managing timber stands for clear logs.

- LOG PS024** - 24" saw (top)
- LOG CS072** - 24" saw with 48" extension (bottom)

### Universal Log Stand

6" Universal log stand - shown attached to the LOG PV060  
60" peavey

- LOG ULS006**



### Peavey

Forged steel socket and driven pick is fitted with Maine hardwood handles and duck bill hook. Used with larger logs.

- PEA T-029-030-0119** - 2 3/8" x 2 1/2' • 5.5 lbs.
- PEA T-029-042-0121** - 2 3/8" x 3 1/2' • 6.5 lbs.

### Peavey

### Mill Favorite

### Mill Favorite Cant Hook

Rigged with flat bill hook and used in skidway work and log trucks - lighter duty.

- PEA T-019-030-0267** - 30" handle • 3 lbs.

### Pickaroon

This tool is chipper safe, with a cast aluminum head on an all wood handle. The only steel is the "forged in" point at the very tip. Light weight and strong!

- PEA T-000-015-0656** - 15" handle • 2 lbs.
- PEA T-000-060-0668** - 60" handle • 3 lbs.

Pickaroon head detail

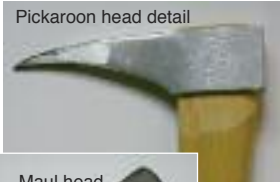

Maul head detail



### 6 Lb. Maul

Wood splitting maul with leather cover. 33" handle

- PEA R-157-036-MAUL** • 8 lbs.

### SEYMOUR

### Splitting Maul

8 lb. Steel head, 36" fiberglass handle

- SEY SM-8FG** • 11 lbs.

### Sledge Hammer

8 lb. Steel head • 36" fiberglass handle

- SEY SH8** • 11 lbs.

### CORONA

### 4 lb. Sledge

14" Solid core fiberglass handle. Tempered steel head.

- COR ST-70020** • 5.5 lbs.

### 8 lb. Sledge

30" Solid core fiberglass handle. Tempered steel head.

- COR ST-70021** • 11.5 lbs

### Michigan Axe

34" Solid core fiberglass handle. Tempered steel head.

- COR AX-70020** • 6.5 lbs.

**NEW**

**COLD STEEL**

### Trail Boss



The Trail Boss is light and compact enough to carry all day in your hand or strapped to your pack. Featuring a European style head with a 4" blade and a 4 1/2" cutting edge, it takes a big bite with every swing. Plus, it features a very stout straight-grained hickory handle. 23" OAL  
**CLD 90TA** • 2.6 lbs.

### BAHCO

### CLEARING AXE

27" multi-purpose clearing axe, replaceable hickory handle.

- BAH 3022** • 2.2 lbs.
- BAH 3029** • Replaceable handle • 13 oz.
- BAH 3028** • Replaceable blade • 3.2 oz..



### LIFTING HOOK

- BAH 1204**
- 14 oz.



### GENERAL PURPOSE AXE

26" axe, for general applications - camping, gardening & occasional trimming & splitting. High quality tool, steel curved head, ash handle.  
**BAH HUS-1.0-650** • 3 lbs.



**NEW Dinowood Firewood Bags**



Rugged nylon bags with open weave for optimum drying. You can fill from a conveyor or just toss in. Holds about 1/3 cord each, randomly filled. Will free stand on a pallet when filled. Great for the person with a wood processor, or for moving firewood around when minimum handling is a must. Filling frame or forks required for efficient use.  
**DIN BB-DINOWOOD**

36"x42"x58" • 2500 lbs. maximum capacity

**ELVEX CORPORATION**  
**ProGuard Loggers Safety Caps**

Elvex ProGuard Caps provide protection for head, face and hearing for saw and equipment users. The cap is supplied with accessory slots on sides for hearing and face add-ons. ProGuard models are CE certified and comply with EN 397, CE 0086.



**ProGuard CU-25R**

4-pt ratchet suspension safety cap, medium profile ear muffs with 24 dB NRR, visor bracket with steel visor. Very economical. Orange.  
**ELV CU-25R** • 2.5 lbs.



**ProGuard CU-30R**

6-pt ratchet suspension safety cap with nylon webbing, that gives a secure fit and balance. HM-2030 low profile ear muffs, 25 dB NRR, visor bracket and nylon visor round out its features. Orange.  
**ELV CU-30R** • 2.5 lbs.



**ProGuard SC-30R6**

6-pt fabric harness ratchet suspension safety cap simply by turning the knob on back. Caps have accessory slots that accept hearing and face protection products. Blue.  
**ELV SC-30R6** • 1 lb.



**ProGuard CU-60**

A Bullard 6-pt suspension safety helmet, equipped with heavy duty cap mount ear muffs with noise reduction rating (27 dB), visor bracket and nylon visor. Orange.  
**ELV CU-60** • 2.5 lbs.



**Heavy Duty Face Protection**

Headgear with ratchet adjustment, sweatband and swivel locks. Browguard permits mounting of a polycarbonate clear shield or steel mesh forestry screen shown. Order HG20 plus shield.

**ELV HG-20** - Face Headgear • .5 lb.

**ELV FS-16PC** - Polycarbonate Shield • .5 lb.

**ELV SV-75** - Forestry Visor - Steel • .25 lb.

**ACCESSORIES**

OESCO carries parts and accessories for most ECHO chainsaws

**ECHO Max Performance™ Bar & Chain Oil and Power Blend Oil**



**Bar & Chain Oil**

ECH 6459012 - 1 quart  
ECH 6459006 - 1 gallon

**Power Blend® Oil**

ECH 6450000 - 2.6 fl.oz.  
ECH 6450025 - 6.4 fl. oz.  
ECH 6450250 - 5 gallons

**OREGON Bars & Saw Chains**



OESCO carries a select line of OREGON products for ECHO chain saws.

Oregon products for other brands are available upon request. Call Us!



**Multi-purpose Wedge**

Durable special plastic.

**GPM 19718** - Small, 5 1/2"

**GPM 19719** - Large, 8"



Headband is double napped terry. Machine wash/reversible.  
**OCC 88501** - Navy Headband



Sweatband installs in an instant by bending over hard hat suspension. 8mm thick, excellent absorbency. **OCC 88001** - Navy Sweatband



**CHAPS**

- Patented asymmetrical protection design
- Easy on, easy off apron style with buckles



**Arbor Chaps**

APA Class B. One size fits all. Universal size chap for length adjustment 33-36. Two leg straps and buckles. Hunter green color with black trim, straps, belt.  
**ELV JE-8000** • 2.5 lbs.



**ProChaps**

BEST SELLING CHAPS. ASTM & APA Class A. 4 lengths. Quick release buckles, pocket. Safety orange.

**ELV JE9428** - 28" • 2.7 lbs.

**ELV JE9433** - 33" • 2.8 lbs.

**ELV JE9436** - 36" • 2.9 lbs.

**ELV JE9439** - 39" • 3 lbs.

**Tool Holsters**



Slips on your belt. Available in 2 styles - 1 that holds a chain saw file and wrench and 1 that holds a wedge, wrench & 2 chain saw files. 3" belt loop. Polypropylene webbing. 11 1/2" long



File, wrench  
**WEA 08-97230**



Wedge, wrench, 2 files  
**WEA 08-97231**



Work Gloves - See pages 110-111



# REARS

Made in the USA

## VERTICAL WALL TOWERS

Louvered air vanes adjust discharge angle. Individual target zone spray controls. Manual or electric air discharge and spray controls. Available with standard or split manifolds for quick spray height variation control. Optional adjustable air doors control discharge volume to compensate for wind conditions.



500 gallon with  
10' radius top tower

**NEW**



500 gallon with  
13' folding tower

## POWERBLAST ENGINE DRIVE

with John Deere Powertech 4.5L diesel engine; 115 HP turbo charged.

Features:

- 400, 500 or 600 gallon stainless steel tanks
- 33" or 38" stainless steel fan
- Electric fan clutch
- Electric throttle
- Electric spray controls
- REARS centrifugal pump
- Stainless steel fan housing
- Rollover no-drip nozzles with ceramic tips



500 gallon  
with 38" fan

## POWERBLAST SPRAYER with OVER ROW TOWERS

**NEW**

Adjustable reach to accommodate your row spacing. Air dams to tune target turbulence. Drop tubes and duct arms break away independently for protection. Folds for easy transport. Stainless steel construction. Reduce overspray by directing air to tree center from three directions at once. Improved coverage which means better pest control.

Pictured on 500 gallon Narrow Powerblast with tandem axles



# REARS Powerblast Spray System

**Flexibility for your application**  
**Durability for performance you can count on**

**Stainless Steel Construction:** tank, fittings & hardware, mechanical agitation, hard plumbing, spray manifolds, fan housing

**Rears Constant Velocity Hitch** - for smooth 90° turns under full loads, nothing beats a Powerblast

**Rears Centrifugal Pump** - 200PSI/80GPM

**Rears Spray Control** - manual, electric or hydraulic

**Double-Rollover Nozzle Bodies** - switch your application rate with a simple twist

**33"- 38" Diameter Axial Flow Fan** - fitted to the stainless steel fan housing for optimal performance

**Time tested design, wide range of applications** - a flexible, durable system



**Our Best Selling Orchard Sprayers**

**powerblast power**

*Variety of model profiles available*



## PUL-BLAST

100-500 gallon stainless steel tanks, multiple profile, medium power, adaptive PTO machine. CV or standard hitch, diaphragm or centrifugal pump, adjustable pitch fans with a two-speed gear box make these sprayers adaptable to many tractor sizes and power requirements. All tanks are provided with mechanical agitation and electric spray controls.



REARS ORCHARD SPRAYERS



**REARS**

# REARS

## PAK-BLAST

The Pak-Blast adapts Rears' cutting edge air-blast sprayer design to 3 point mounted applications. By nesting the heavy duty gearbox and pump within the tank profile, Rears has shifted the center of gravity forward toward the tractor lift arms. The result is a high-performance sprayer that can be matched to the most compact orchard tractor.

Available in 50, 75, 100 and 150 gallon tank size.

The Pak-Blast has a selection of aluminum alloy axial flow fans - 24" to 28" diameter. The fan is fitted to the fan housing to produce optimal performance. All fans have variable pitch.



50 gallon Pak Blast, 24" fan



50 gallon Pak Blast



100 gallon Pak Blast



Engine Drive Sprayers

These small trailer sprayers offer the power of a tractor driven sprayer with the versatility of a narrow self contained unit.



This 36" wide sprayer features a Vanguard engine, 20" fan that can be disengaged, Hypro D30 diaphragm pump, Teejet nozzles with diaphragm checks, turf tires and clevis hitch. Available in 50 and 100 gallon tank sizes.

Great for use with an ATV or small garden tractor in Christmas trees, vineyards, berry plantations and dwarf orchards.



## A200 Airblast Sprayer

Jacto A200 airblast sprayers deliver big performance in a small package. Filled with features that ensure long life, excellent durability and maximum crop protection for hobby farmers and small growers, Jacto designed the A200 to economically meet the demands of orchard, vineyard, Christmas tree, berry, and other fruit and nut applications. Specifically designed for compact tractors working in tight areas.



## Durand Wayland PTO Sprayers

- AF505CPS - Highest performance - 65"-78" wide
- Silverliner - Medium performance - for medium or smaller plantings - 64"-76" wide
- Microliner - Medium performance - 48" wide, for smaller apple, raspberry or grape plantings



## PTO Driven REDLINE Sprayers

300, 400, 500 or 600 gallon stainless steel tanks with mechanical agitation, conventional or tracking hitch models, 28", 32" or 36" fans and diaphragm, piston or centrifugal pumps.





J-400



### Jacto J-400

3 pt. hitch, 105 gallon polyethylene tank with mechanical agitation, 37 gpm, centrifugal pump three outlet cannon head with hydraulic lift and rotation available. 40 pto HP required 60' plus swath. Pictured above.  
**JAC 142190**

### Jacto J-600

3 pt. hitch, 158 gallon polyethylene tank with mechanical agitation, 35 gpm, pto driven centrifugal dual stage pump with hydraulic head rotation and deflector setting. 50 pto HP required 90' swath.  
**JAC 339259**

The J-600 CHT is a new version of the J-600 export, designed for farmers who have been using the hydraulic system of the tractor to move the cannon head both vertically and horizontally while spraying.



J-600



R1915 Trailer Canon Sprayer

### MS Super Canons

- General features
- Polyethylene tank
  - Centrifugal pump
  - Fan lock release knob
  - Fiberglass air duct, corrosion resistant
  - 230° cannon rotation
  - 35° (+20°, -15°) cannon vertical adjustment
  - Clean water dispenser
  - 3 section electric control, 300psi



P1135 Canon Sprayer

### AGTEC 3004

Large capacity 3 Pt. Hitch 540 rpm PTO driven air row crop sprayer, 100 gallon fiberglass tank, 120 gpm centrifugal pump, accurate meter, 12v electric valves, model 3000 squirrel cage fan, model 3000 rotating row crop head 12 volt operation.

Standard equipment: combination fan housing for orchard/row crop heads.

Options available: row crop head, orchard head, nut tree heads, VMC tower heads, 150 gallon tank, hydraulic rotation, sight gauge in tank, stack extension.



3004 with Row Crop Head

AIR ROW CROP SPRAYERS

*For growers, gardeners and groundskeeping professionals.*

Available as skid or trailer models with 25, 50 or 100 gallon tank size. All tanks are stainless steel with mechanical agitation. Trailers are offered with boat trailer tires or turf style. All models have Honda engines and diaphragm pumps for long life and low maintenance.



100 gallon Nifty skid, AR30 pump, Honda 5.5 HP engine.



50 gallon Nifty skid, AR30 pump, Honda 5.5 HP engine



25 gallon Nifty with boat trailer tires

### Rears Pul Tanks



50 gallon, AR30 pump, 5.5 HP Honda engine with turf flotation tires.



50 gallon Nifty trailer with flotation tires and Rears Nifty Boom

**Commercial Skid Sprayers - Available with 50-1000 gallon stainless steel, single or multiple tanks with mechanical agitation. Pumps and engine options available up to 60GPM and 700PSI to meet your needs. Reels, hoses and guns are available to fit each application.**



Rears multiple tank skid sprayer  
500/200/200 gallon  
John Deere diesel engine  
High pressure diaphragm pump



Rears 300 gallon skid  
Honda engine  
Medium pressure diaphragm pump



Rears multiple tank skid sprayer  
Multiple engine and John Bean piston pumps



Rears 300 gallon skid  
Honda engine  
High pressure diaphragm pump



Rears 100 gallon 304SS low profile skid  
Honda engine  
Diaphragm pump



Rears 600 gallon high pressure skid sprayer  
Custom paint colors available

REARS SKID SPRAYERS

# SIMPLE, FAST HOOKUP WITH YOUR PICKUP!

## REDUCE SAND & SALT with OUR LIQUID DE-ICER



### The Low Profile Skid De-Icer Unit!



#### Main Features:

- Low profile, black powder coated frame; anchors at each corner
- Compact design for installation in a pick-up truck
- Two-inch Banjo poly centrifugal pump
- Honda 5.5 HP gas engine

**MSS DC205G-H** • 205 gallons

**MSS DC305G-H** • 305 gallons

#### Options:

- **SET BOOM-NO-VALV** - 7 Nozzle Boom with 2 receiver mount
- **SET 25-SALT-PILE** - Kit with 25' hose to wet granular salt pile
- **SET 25-REFILL-HS** - Kit with 25' of 2" suction hose with 2" cam couplers



### CARGO-50 SPRAYER

Shown with optional boom



- CARGO Series sprayers for utility vehicle or compact trucks
- Polyethylene tank, 5" lid
- Agitation by Venturi nozzle
- Tank drain
- 12 VDC Flojet diaphragm pump #4300-143, 4.5 gpm, 45 psi
- Remote switch
- Manual control, one valve for boom section, glycerine pressure gauge
- 25' hose and gun with adjustable cone nozzle

**MSS CARGO-50** - with 50 gallon tank

**MSS CARGO-100** - with 100 gallon tank

**MSS CARGO-200** - with 200 gallon tank

**MSS R12M-CARGO** - 12' vertical fold boom



### Hydro-seeding Units

- Tank: 500 gallon\*
- 3" cast iron centrifugal pump: 300 gpm, direct drive
- Honda gas engine: 11 HP, with manual start
- Hose reel: manual, 1"
- 150' long hose: 1" diameter
- 2 quick-coupler fan nozzles and tool box
- Mulch bale chute

**MSS HS500**



\*Other tank sizes available

### MS Watering Sprayers

200 - 500 gallon tanks, 2" Banjo centrifugal pump, 5.5 HP Honda engine, reels and discharge hoses available - **Contact us for details**



### Herb-Matic IIC

Herb-Matic is designed for a minimum use of pesticide in a one pass system. Spot treat as you apply fertilizers.



This system injects pesticide in a coaxial hose. The double trigger allows options to the operator for lawns: Apply fertilizer and full pesticide coverage simultaneously or apply fertilizer and pesticide on demand. System is adaptable to your sprayer. Cabinet has a seven gallon polyethylene tank for pesticide concentrate and a 12 volt injection system, double feed reel, 300 feet of coaxial hose, and a double trigger gun.

**MSS Herb-Matic IIC**

MS DE-ICER/HYDRO SEEDERS



## MS Skid Sprayers

Polyethylene and fiberglass spray tanks are available mounted in steel frames and feature agitation by venturi nozzles in the tank.

Comet diaphragm pumps offer positive displacement pressure and volume options up to 580 psi and 20 gpm.

Many sizes of tanks and styles are available. Herb-Matic pesticide injection systems are optional. Sprayer tank and pump/reel modules available in sizes and installations to suit the job. Compact sized.



MS C765 200 Commercial Compact Skid

Compact transverse mounted, space saving design



12 volt version for closed van



MS Commercial skid models

MS SKID/TREE SPRAYERS

## Tree Sprayer Package



## Tree Sprayer Package

From MS and OESCO



500 gallon elliptical tank, sparge tube agitation, high pressure Comet plunger pump, Honda electric start engine, Hannay 6000 Series electric rewind reel, 3/4" high pressure spray hose with gun and swivel.





# Legendary John Bean Skid Sprayers



John Bean multiple tank skid sprayer  
600/200/200 gallon

Positive displacement piston pumps available from 5-60GPM up to 800PSI. Stainless steel, fiberglass or poly tanks in single or multiple versions. All steel skid frames and mechanical agitation. Contact us for specifications.

We have a huge inventory of parts for older and newer John Bean sprayers



John Bean 300 gallon tank,  
20 GPM pump



John Bean 100 gallon tank, 10 GPM pump



John Bean 500 gallon 20 GPM pump

## RECOMMENDED PUMP CAPACITY, PRESSURE AND TIPS FOR SHADE TREE SPRAYING

PUMP GPM	PUMP PSI	HOSE SIZE	GUN & DISC	NOZZLE PSI	TREE HEIGHT
60 50	600-800# with 100' of 3/4" hose	3/4"	785 equipped with special kit and #22 disc	450 - 550	65' to 110'
35	600# with 100' of hose	3/4"	785 equipped with special kit and #16 disc	450 - 550	50' to 70'
35 25	600-700# with 200' of hose	3/4"	785 & #14	450 - 550	40' to 65'
20	400-500# with 100' of hose	5/8"	785 & #14	250 - 350	35' to 50'
10	400# with 100' of hose	1/2"	785 & #10	300 - 350	20' to 35'
5	400# with 100' of hose	3/8"	757 & #7	250 - 300	10' to 25'

JOHN BEAN SPRAYERS/FEEDING NEEDLES



Manufactured by



### OUR OWN FEEDING NEEDLE

This high pressure, high volume needle is manufactured out of thick wall steel pipe tapered and threaded together. Complete with adjustable step plate (doubles as splash plate). A high pressure 3/4" squeeze handle valve is mounted in the 3/4" pipe handle. A 3/4" FHT brass adapter is included ready to attach to hose. The tip is interchangeable: 2, 3, 4 or 6 hole. Please specify which tip when ordering. Length 40". All parts available.

	GPM at 200 PSI	Replacement tips:
<b>ORC FN-12</b> (2 hole tip) • 10 lbs.	13	<b>ORC FNT-2</b> 2 hole • .25 lb.
<b>ORC FN-13</b> (3 hole tip) • 10 lbs.	20	<b>ORC FNT-3</b> 3 hole • .25 lb.
<b>ORC FN-14</b> (4 hole tip) • 10 lbs.	27	<b>ORC FNT-4</b> 4 hole • .25 lb.
<b>ORC FN-16</b> (6 hole tip) • 10 lbs.	40	<b>ORC FNT-6</b> 6 hole • .25 lb.

Replacement valve: **KIN 305A5-1** - 3/4" squeeze valve  
Valve repair kit: **KIN 305AFF-5-KIT**



Digital Flowmeter available  
See page 83

25 to 200 gallon size • Standard or heavy duty frames • 3 pt. hitch or front mount

Pak Tank sprayers come standard with stainless steel tanks, mechanical agitation, pto shaft driven diaphragm pumps and sway chains. Many models of booms, guns and hose available. Excellent for small fruit, Christmas trees and general row crop spraying.

Front mount Pak Tank



50 gallon narrow Pak Tank



100 gallon Pak Tank



200 gallon Pak Tank  
Heavy duty frame



50 gallon Pak Tank  
with 2 section boom



100 gallon Pak Tank with orchard weed boom



100 gallon Pak Tank with 3 section boom

### Orchard Weed Boom

The telescoping length of this boom adjusts to the needs of the operator. Mounts right or left side of tractor on transmission belly side. Three stock models available. Kit includes hose, spring hinge and manual valve. Many options including 12v electric valve. 1, 2, 3 nozzle models

REARS PAK-TANK SPRAYERS

# WE ARE SPRAYER EXPERTS!

We are one stop shopping: Call OESCO, Inc. for all your sprayer parts, accessories & calibration needs. Call to speak with one of our specialists today! We are always happy to help you!



## QJ360C Nozzle Body Series

- Available with either 3, 4 or 5 spray positions for easy change of spray tips or quick boom flushing
- Positive shutoff between each position
- Automatic spray alignment using flat fan spray tips
- Maximum operating pressure of 300 PSI (20 bar)



### for Dry Booms

Available in 20 mm, 25 mm, 1/2", 3/4" or 1" single or double hose shanks



### for Wet Booms

Available in 20 mm, 25 mm, 1/2", 3/4" or 1" pipe connections

### Single Nozzle Bodies for Dry Booms

for 3/8", 1/2" and 3/4" hose



QJ100 Series Quick TeeJet Nozzle Body



QJ200 Series Diaphragm Check Valve Quick TeeJet Nozzle Body



QJ300 Series Diaphragm Check Valve Quick TeeJet Nozzle Body

### Single Nozzle Bodies for Wet Booms

for 1/2", 3/4" and 1" pipe mount



Type QJ22187-NYB Diaphragm Check Valve Quick TeeJet Nozzle Body (side mount)



Type QJ17560A-NYB Diaphragm Check Valve Quick TeeJet Nozzle Body



Type QJ7421-NYB Quick TeeJet Nozzle Body

## Quick TeeJet Caps and Adapters



### Hose Shank Nozzle Bodies

For Operating Pressures up to 125 PSI (9 bar)

Brass, stainless steel, Nylon and Celcon®/ stainless steel hose shank nozzle bodies. Features 11/16"-16 TeeJet threaded outlet.



Single Hose Connection



Double Hose Connection



QuickJet Round Clamps



QuickJet Square Clamps



Standard clamps for dry booms available for round or square tubing



Brass

Standard TeeJet threaded caps available in brass, SS or nylon



Nylon

Call for your complete TeeJet Catalog today!



**NEW**



Avoid over and under application of chemicals

Accurate flow rate measurements in seconds!

- Quickly find worn spray nozzle tips - Industry guidelines recommend tip replacement once flow rate exceeds that of a new tip by 10%.

- Accurately measure true tip flow rate - Today's high tech sprayers can only be properly calibrated and confirmed with this knowledge.

- Fast and simple operation - Readings in 10 seconds or less per trip.

SPO 23890 - SC1 Calibrator

BOOM COMPONENTS/CALIBRATORS



## Sprayers and Booms

Wet and dry booms manufactured from sturdy steel tubing and powder painted. The tubular frame is made to give adequate support to different accessories and add stability while in operation or in storage. Choose a tank size, pumping unit, manual or electric control and a manual or hydraulic folding boom from a wide range of models.



**MSS P50** - 3 pt hitch sprayer, Cat #1 with R12M 12' boom



**MSS P950E** - with 45' hydraulic boom



**MSS P150** - with 28' X-Fold boom



**MSS P110** - with 22' manual boom



**MSS R190** - with R15MV boom



**MSS P300-P** - with 60' Monarch boom



**MSS T1000**

MS BOOM SPRAYERS

Rears stainless steel tanks with mechanical agitation are mounted on steel frames using pto driven diaphragm pumps. Stainless wet boom pipes provide the base for steel framed booms. Available with hydraulic or manual boom fold and lift options. Tank sizes from 50 - 1000 gallons in 3 pt. hitch and trailer.



Coil shock boom on Pul Tank



DP Boom mounted in utility vehicle with 304 Rears sprayer.



Trellis boom with 4 nozzle pipes on Nifty Pul Tank



DP Boom by Rears

3 section booms with steel tubing and stainless wet boom pipe. Nozzles are diaphragm check with stainless tips. Call for details and specifications.

**Easily retrofits onto most brands of sprayers**

RMCO hydraulic fold boom on heavy duty Pak Tank



Pak Tank HD RMCO Boom

REARS/ESS BOOM SPRAYERS

## ESS Air Assisted Electrostatic Spray Systems

PTO row crop spray procedures feature low volume spraying down to 5 GPA. These systems provide air assisted electrostatic spray directed to cover the target. Special booms provide air and electrostatic nozzle placement to the crop.



**Special note: Large row crop boom sprayers are NOT a stocked item and time must be planned for manufacture and delivery.**



50 gallon polyethylene tank with a 4 HP Honda engine and Comet MC25 diaphragm pump, hand reel swivel mounted, 100' of 3/8" hose and spray gun. Mounted on a cart with 3 or 4 wheels. Trailer hitch optional. Other hand booms optional. Electric motor drive option also available.



50 gallon

**MS offers polyethylene tanks, Comet diaphragm pumps and Honda gasoline engines. Many options include booms, hose, reels and guns.**

- 30 gallon tank
- 110V electric or Honda gas motor
- Narrow for your aisles, only 27" overall width
- Perfect mix into the tank with venturi agitation
- Hose rack or hose reel
- MC25 diaphragm pump, 6 gpm, 350 psi
- Easy to push with the big wheel kit



30 gallon



### Walk Behind Sprayer



The **S25 Spray-PRO Mark III** is a revolutionary new product designed to take the work out of spraying your lawn, sidewalk, driveways, paths, and gardens. Use in spring, summer, fall, and for winter ice control. With a spray width of 2 - 5 feet, and up to a 11,600 sq.ft. coverage, the S25 will make quick work when spraying herbicides, pesticides, fungicides, fertilizer, or liquid ice control products.



The adjustable height nozzle will reduce the spray width for narrow banding operations. Having a 6.6 gallon capacity self-agitating tank, the S25 will do the job of several tank sprayers without the pain of carrying them in hand or on your back. With the ground driven pump, and no battery, the S25 operates at walking speed and pushes easily.

Designed for Commercial use, the S25 will perform under daily use by contractors, as well as the occasional use of the homeowner with equal results. When you need to apply a liquid in any season for any reason, the S25 is there to help put an end to the work. Packaged to ship UPS.

**EAR S-25** • 32 lbs.

## REARS

Made in USA



### NIFTY NURSERY CART SPRAYER

25 gallon wheelbarrow style Nifty Sprayer. Specifications: 25 gallon stainless steel tank, mechanical agitation, stainless lid, basket strainer, volume sight gauge, suction strainer with valve, pressure gauge, pneumatic bicycle tires and steel handles. Pump: AR 252, 2 diaphragm 6 gpm, 290 psi Motor: 3 HP Briggs & Stratton, 3 HP Honda or 1 HP, 110V AC electric motor. Accessories: 25' of 3/8" PVC hose, BR 380 brass spray gun. Options: Trailer hitch

### NIFTY 50 GALLON FOUR WHEEL HAND CART SPRAYER

- 50 gallon S.S. tank with mechanical agitation
- 5.5 HP Honda recoil start engine
- AR 30 - 9 GPM 500 PSI diaphragm pump
- Hannay manual rewind reel
- 200' of 1/2" hose
- Green Garde JD9 spray gun



### MIGHTY MAC Gasoline Powered Sprayer

For homeowners with larger spray needs. Wide sprays for lawns, gardens, jet sprays for topping 25' trees. Tow by hand or pull it with riding mower or tractor.

- 3 1/2 HP Briggs & Stratton 4 cycle engine
- Hypro twin piston pump, delivers up to 3 gpm at 300 psi
- Direct drive from engine to pump
- Durable 22 gallon, 200 mil polyethylene tank
- Pistol grip gun
- 25' high pressure 3/8" hose
- 5 1/2" diameter top opening for easy fill
- Rugged, heavy steel frame
- Pressure relief valve and stainless steel in-line strainer
- 10.5 x 3.5 turf type pneumatic tires on ball bearing wheels
- 39"L (plus tow bar) x 29"W x 38"H
- Weighs 120 lbs.



**MAC PS322T**

GREENHOUSE/CART SPRAYERS



### MSS CARGO-50 12 Volt Skid Sprayer

- CARGO50 sprayer for utility vehicle
- 50 gallon US polyethylene tank, 5" lid
- Agitation by venturi nozzle
- Tank drain
- 12 VDC Flojet diaphragm pump #4300-504, 4.5 gpm, 45 psi
- Remote switch
- Manual control, one valve for boom section, glycerine pressure gauge
- 25' hose and gun with adjustable cone nozzle

**MSS CARGO-100** - same as CARGO-50 with 100 gallon tank

**MSS CARGO-200** - same as CARGO-50 with 200 gallon tank



### Optional Booms

**MSS MS-R12M** - 12' boom, vertical manual folding

**MSS MS-R15MH** - 15' boom, horizontal manual folding



## ATV Sprayers and Accessories

Spot Sprayers ... Great for treating small isolated areas. For pesticides, herbicides or liquid deicing products



16 gallon sprayer

Order Online



26 gallon sprayer



### Tree Sprayer

- Tree sprayers operate at higher pressures, allowing for higher spray heights and an atomized mist for delicate flowers
- Small isolated areas like individual weeds are more difficult to treat
- Tree sprayers are available in ATV models and tow behind models

### 16 Gallon ATV Tree Sprayer

16 gallon poly tank. 12V, 2 GPM, 200 PSI Pumptec pump. 35"x3/8" hose with spray gun. Sprays up to 30'. **GPM 268180** - 30 lbs.

### 16 Gallon ATV Spot Sprayer Roundup Ready!

16 gallon poly tank, 2.2 GPM Northstar pump, 60 PSI. 15"x3/8" hose and wand with adjustable spray pattern. Tie down straps included. **GPM 26810** - 25 lbs.

### 26 Gallon ATV Spot Sprayer

26 gallon poly tank. Equipped as **GPM 26810**. **GPM 268120** - 27 lbs.

### ATV Broadcast Kit (not pictured)

14' spray pattern with just 1 nozzle. Mounts to ATV hitch. **GPM 268195** - 10 lbs.

12 VOLT SPRAYERS/FOAM MARKERS

## Foam Markers

### REARS

### REARS PAK-MARK

12V compressor foam marker available in several models. Normally used in turf, cranberries and row crops. Adaptable for any sprayer or spreader, requires 12V power supply.

**REA PM1-S** - one sided  
**REA PM2-S-RC** - 2 sided w/ remote control box

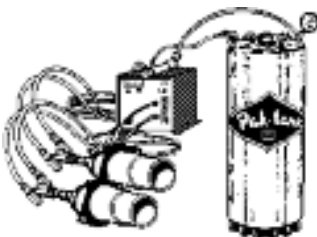

3 models of affordable compact turf markers. Can be used with broadcast sprayers, drop spreaders and sprayers with booms up to 18' long. Use dish soap or turf marking soap. TTR-1101 or TTR-3301 can be mounted as a center drop on spreaders.

For spreaders or sprayers up to 36" wide. 32 oz. tank, power unit, tubing and mounting components uses D cell battery.

**RIC TTR-1101**

For spreaders or sprayers up to 8' wide. 60 oz. tank, single air pump, remote switch, tubing 12V vehicle battery powered.

**RIC TTR-3301**

For spreaders or sprayers up to 18" wide. Dual 60 oz. tanks, dual air pumps, remote switch for each side, tubing 12V vehicle battery powered.

**RIC TTR-4401**

Richway Fomalot Turf Special Foam Concentrate **RIC TFM01** - 1 gallon

**Hannay hose reels come in many sizes and capacities.**

Hannay Reels is the leading manufacturer of high quality hose and cable reels for most every conceivable application. This page describes and gives specifications on our most popular hose reels. *If you don't find what you're looking for, give us a call and we will help you meet your needs.*



**Series 1500**

Inlet: Standard inlet is 90° ball bearing swivel joint with 1/2" female NPT threads.  
Outlet: Standard outlet is 3/4" male GHT threads.  
Operating Pressures to 3000 psi



**Series 1800**

Inlet: Standard inlet is 90° ball bearing swivel joint with 1" female NPT threads.  
Outlet: Standard outlet is 3/4" male GHT threads.  
Operating Pressures to 1000 psi



**Series 6000**

Inlet: Standard inlet is a 90° ball bearing swivel joint with 1" female NPT threads.  
Outlet: standard outlet is 3/4" female GHT threads.  
Operating Pressures to 1000 psi.



MODEL	Hose capacity of reel			
	1/4" I.D.	3/8" I.D.	1/2" I.D.	5/8" I.D.
	5/8" O.D.	3/4" O.D.	7/8" O.D.	1" O.D.
1514-17-18	175 ft.	125 ft.	75 ft.	50 ft.
1520-17-18	350 ft.	275 ft.	175 ft.	125 ft.
1526-17-18	500 ft.	400 ft.	300 ft.	200 ft.
1530-17-18	—	500 ft.	375 ft.	275 ft.
1536-17-18	—	—	475 ft.	350 ft.

HAN 9927.8551 - Replacement swivel 1/2"

MODEL	Hose capacity of reel	
	5/8" I.D.	3/4" I.D.
	1" O.D.	1-9/32" O.D.
1816-17-18	75 ft.	50 ft.
1822-17-18	150 ft.	100 ft.
1826-17-18	200 ft.	125 ft.
1830-17-18	275 ft.	150 ft.
1836-17-18	350 ft.	200 ft.

HAN 9929.8551 - Replacement swivel 1"

MODEL	Hose capacity of reel		
	1/2" I.D.	3/4" I.D.	1" I.D.
	7/8" O.D.	1-9/32" O.D.	1-9/16" O.D.
6024-19-21	235 ft.	125 ft.	60 ft.
6032-19-21	350 ft.	200 ft.	100 ft.
6024-23-24	450 ft.	185 ft.	100 ft.
6030-19-21	—	250 ft.	150 ft.
6038-19-21	—	350 ft.	200 ft.

HAN 9929.8551 - Replacement swivel 1"

**Portable Garden Hose Reels ... for grounds maintenance and home use**

**Series GH1100**

Inlet: Standard inlet is 90° ball bearing swivel joint and 1/2" female NPT threads  
Outlet: Standard outlet is male GHT threads.  
Operating Pressures to 3000 psi.  
Hose Capacity: 3/8"(I.D.)/300 ft. 1/2"(I.D.) /200 ft. 5/8"(I.D.) /150 ft.

**HAN GH1100**

HAN 9927.8551 - Replacement swivel 1/2"

**Series GHAT1200**

Inlet: Standard inlet is 90° ball bearing swivel joint with 1" female NPT threads.  
Outlet: Standard outlet is male GHT threads.  
Operating Pressures to 1000 psi.  
Hose Capacity: 1/2"(I.D.) /375 ft. 5/8"(I.D.) /200 ft. 3/4"(I.D.) /150 ft. 1"(I.D.) /100 ft.

**HAN GHAT-1200**

HAN 9929.8551 - Replacement swivel 1"



**FH-3 Roller and Spool Assembly**

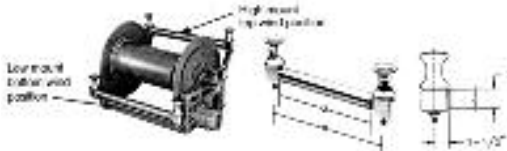

Speeds handling and reduces hose wear. Buffed stainless steel rollers resist corrosion, pitting and abrasion. Polished, chrome-plated spools and blocks add lasting beauty to your equipment. Delrin bearing surfaces assure quiet operation and minimum wear.



**Utility Hose Rollers**

Stainless steel rollers and cast alloy brackets for use on the reel, on cabinet door openings, truck platforms and similar locations where sharp edges may cut or damage hose/cable.



## Polmac Control Units

These units have been designed and manufactured with special materials suitable for any application in the field of crop spraying and protection. The nylon and stainless steel components are highly practical, corrosion-proof and resist the corrosive action of sprayed chemicals and liquid fertilizers. Contact us for sizing to your sprayer.



4 Valve controller with unloading relief valve and gauge  
**POL 00280004**

**NEW**



4 Valve controller with unloading relief valve, bypass metering valve and gauge  
**POL 00304304**

**NEW**



### Pony Flow 9V Sensor/Counter

For use with Polmac flow meters. Can be mounted directly to body of the flow meter or remotely mounted. Functions include Start, Stop, Auto On, Auto Off, Running Total and Final Total. Measures in US gallons, Imperial gallons or liters. Up to 99,999,999 units.

Model	Order #	Flow Meter
		Sensor
Pony Flow 4	<b>POL CH370001</b>	ST. 1/2"-3/4" INOX - 1/2' NYLON 30306032.CDE
Pony Flow 4C	<b>POL CH37000C</b>	STANDARD >3/4" 30306032.DEU
Pony Flow 4 Remote	<b>POL CHRE0001</b>	RAPID CHECK 41308899.DEU



## Pony Flow Plus 12 V

Cab mount displays for flow meters.

Many options available. Features flow rates and totals, ground speed, pressure, and/or control of 12V DC motor drive valve. Call for application and part numbers.



## Pro-Flow

This is a 1 1/2" or 2" (9 to 90 gpm), 250 psi maximum, programmable stop flow meter. The operator programs the set amount, manually opens the valve, and when the desired amount is reached the valve automatically closes. Comes as compact (1) or remote (2). Great for filling spray tanks.



Pro-Flow 1	(A) Signal	(B) Signal	Part #
1 1/2"	12 Vcc.	0 Vcc.	<b>POL 00379007</b>
2"	12 Vcc.	0 Vcc.	<b>POL 003790G2</b>

Pro-Flow 2	(A) Signal	(B) Signal	Part #
1 1/2"	12 Vcc.	0 Vcc.	<b>POL 00379010</b>
2"	12 Vcc.	0 Vcc.	<b>POL 003790G3</b>

(A) - Output signal with throttle valve open  
(B) - Output signal with throttle valve closed

## Nozzles for Washing Containers

Used to clean chemical products out of emptied containers before they are disposed. Consists of a central shaft on which rotates a fluid activated nozzle that is able to rotate through 360° to spray the inner surfaces of the container.

**POL 63408499** - Rotating

Extractable (1)

**POL 6340849S** - Slim Rotating

Extractable (2)



(1) (2)

## Nozzles for Washing Tanks

Used to clean chemical products out of tanks and mixers. Its fluid activated rotating head covers 360° and performs a complete wash. It delivers 7.4 gallons per minute at 70 PSI.

**POL 63408399**

**POL 6340839R**



POL 63408399 POL 6340839R

## CenterLine 220 GPS Guidance System



### COMPACT GUIDANCE FOR ANY APPLICATION

- Versatile GPS guidance in a compact, portable package
- Traditional lightbar guidance and a graphic display provide guidance information
- High-quality internal GPS engine with external antenna
- Straight-line (parallel) and curved AB guidance modes
- Durable, sealed rubber keypad is easy to see and provides good tactile feedback for the operator
- Provides radar-like speed for use with other control systems that require a speed signal

**MWT 90-02399**



## The TeeJet 844-AB

Designed exclusively for orchard spraying and available with a conventional wiring system or junction box to customize features.

- Convenient operation. Individual boom control switches allow the operator to accurately manage spray application by changing spray patterns according to tree height.
- Greater accuracy. When a boom section is shut off, the system can automatically maintain system pressure. This prevents over-application when spraying sections of smaller trees.
- Improves efficiency. Individual boom controls allow you to shut off boom sections from the tractor seat. Time will no longer be wasted getting on and off the tractor to shut off valves.
- On-the-go swath width adjustment allows operator to go from one orchard to another without reprogramming.
- Automatic control is fast and stable.
- Built-in planning tool helps match application rate, tip capacity and pressure.
- Large backlit display shows all spraying information at a glance.
- Control up to four boom sections plus master shutoff.
- Flow or pressure-based regulation options provide reliability and flexibility.
- Single cable connection for quick hookup.

**MWT 90-50018** - Core kit, 844-AB-4 (console w/ mounting brackets, cables and manual). Speed, flow and pressure sensors sold separately.



### GREEN GARDE® FLOW MASTER®

Digital Flow meter, no moving parts, measures rate and volume to 100th of gallons, pressures 5-500 psi, accuracy +/- 2% 9 V battery

**GRE 38950** - .03-3 GPM rate  
3/8" FPT

**GRE 38951** - 1.0-10 GPM rate  
3/4" FPT



Aluminum turbine meter with LCD readout for gallons with 1" NPT threads.



0.3-3 GPM. Field replaceable batteries. Factory and field calibration. 300 PSI max.

**GPI 113900-9500** • 2 lbs.

Aluminum turbine meter with LCD readout for gallons with 1" NPT threads. 3-50 GPM. Field replaceable batteries. Factory and field calibration. 300 PSI max.

**GPI 113900-9501** • 2 lbs.

Nylon turbine meter for 0.3-3 GPM. LCD readout. Field replaceable batteries. Factory and field calibration. 1" NPT. 150 PSI max.

**GPI 113900-9510** • 1 lb.

Nylon turbine meter for 3-50 GPM. LCD readout. Field replaceable batteries. Factory and field calibration. 1" NPT, 150 PSI max.

**GPI 113900-9511** • 1 lb.

Stainless steel turbine meter for 3-50 GPM. LCD readout. Field replaceable batteries. Factory and field calibration. 1" NPT, 800 PSI max.

**GPI G2S10N09GMA** • 7 lbs.



MICRO-TRAK SYSTEMS, INC.



### CALC-AN-ACRE® II SPEED AND ACREAGE MONITOR

Digital speedometer and acreage counter. 12V operation from the vehicle battery, magnetic wheel or drive shaft pickup. Holds two acreage counts in memory. Measures speed, area and distance. This device includes a console, speed sensor and installation hardware and instructions.

**MIC 01000** - Calc-an-acre II

# Hypro®



### Shurflo Pumps

**HYP 8000-541-236** Lawn and garden pump 12v, 1.0 GPM, 60 psi demand switch, 3/8" NPTF ports

**HYP 8000-543-236** Standard pump 12v, 1.8 GPM, 60 psi demand switch, 3/8" NPTF ports

**HYP 2088-313-145** Standard pump 12v DC, 3.6 GPM, open flow (2.6 GPM@40 psi) 45 psi demand switch, 1/2" MSPT ports.

**HYP 2088-394-144** Standard pump with 6' power cord, 115 V AC, 7 amps, 3.0 GPM, 45 psi demand switch, 1/2" MSPT ports.

**HYP 4211-035** Power twin, 12 v, DC, 8.7 Amps, 6.25 GPM open flow (3.5 GPM@40 psi) demand switch, 1/2" MPT ports.

**HYP 8000-543-220** Standard bypass pump 1.5 GPM open flow, 60 psi internal bypass 3/8" NPTF ports.

**HYP 8030-813-239** High pressure pump, 1.6 GPM open flow, (.83 GPM @ 150 psi) demand switch, 3/8" NPTF ports.



### Straight Swivel Pump Fittings

**HYP 234-2916** - 1/2 FPTx3/8 Barb

**HYP 234-2926** - 1/2 FPTx1/2 Barb

**HYP 234-2936** - 1/2 FPTx5/8 Barb

**HYP 234-2946** - 1/2 FPTx3/4 Barb



### 90° Swivel Pump Fittings

**HYP 234-3916** - 1/2 FPTx3/8 Barb

**HYP 234-3926** - 1/2 FPTx1/2 Barb

**HYP 234-3936** - 1/2 FPTx5/8 Barb

**HYP 234-3946** - 1/2 FPTx3/4 Barb

# Hypro®

## SRS-600 PROPACK™

The electric SRS600 offers convenience, versatility, and comfort in a back pack sprayer. Propack eliminates the need for the operator to continually "Pump Up" the sprayer to maintain a steady spray pattern as with manual sprayers, making spraying faster and easier. It works well with many materials including herbicides, insecticides and anti-icing liquids.



### Features:

- Sprays up to 120 gallons on a single charge
- High performance chemical resistant SHURflo pump
- Variable speed and adjustable nozzle for light or heavy duty spraying
- Ultra comfortable ergonomic design, full back pad, and thickly padded shoulder harness
- Adjustable spray tip provides a uniform cone pattern
- Heavy duty hand lever can be locked in the open position reducing operator fatigue
- 24" spray lance provides easy reach for accurate spraying
- 4 gallon polyethylene tank

**HYP SRS-600** - 12 volt sprayer • 15 lbs.



NeverPump® Bak-Pak®  
Sprayer  
Sprays for 10 hours on a  
Single Battery Charge!



### Professional Grade Features:

- Braided power sprayer-style hose
- Large poly shut-off valve - comfortable, thumb operated
- Extra long 20" poly spray wand
- Bonus nozzle system includes 4 different nozzles
- Lead acid battery sprays for 10 continuous hours on a single charge
- Includes AC charger that completely charges battery in 9 hours
- Extra large fill opening prevents spills when adding chemical
- 4 gallon tank
- 1 Year warranty

**GRE 13854** • 15 lbs.

FLOW METERS / 12V SPRAYERS



### **GAS POWERED SPRAYER**

5 gallon gas powered backpack sprayer with centrifugal pump. Sprays a mist or combination stream to 20' with optional gun. All seals and O rings are Viton™, 21.2 cc 2 cycle engine, 5 gallon formula tank with 145 psi maximum pressure.

#### **ECH SHR-210**

21cc/5 gallon sprayer • 17.1 lbs.



### **SUPREMA™ STAINLESS STEEL BAK-PAK® SPRAYER**

- Large Bak-Pak® Style for Bigger Jobs
- Braided power sprayer-style hose
- Locking metal Roto-valve™ shut-off, rotates 360° for ergonomic comfort
- Strong brass 18" spray wand
- Brass cone nozzle adjustable from mist to long range spray
- Filler filter keeps out debris
- Left or right hand pumping
- Includes padded straps
- All metal pump
- 1 Year warranty
- 4 Gallon

**GRE 67367**

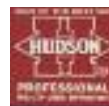

Over 50 years of motorized backpack sprayers

#### **SOL 450 • 23 lbs.**

Engine: Solo 2 cycle  
Horse Power: 3.3HP  
Capacity: 3 gallons  
Range: 38'

**Accessories for SOLO 450**

**Dusting attachment**  
SOL 4900550

**ULV Nozzle**  
Requires liquid booster pump  
SOL 4900479

**Liquid Booster Pump**  
For vertical spraying or ULV attachment  
SOL 4400235

**Double Nozzle**  
SOL 4900137



### **X-PERT® HAND SPRAYER**

Viton equipped, 2.6 quart poly pump, poly tank.  
**GRE 99142 - 2.6 quart • 1.6 lbs.**



Polypropylene design. Working pressure - 60 psi  
Tank capacity - 48 oz.

**TRU P-50-Y • 1.6 lbs.**



### **TROMBONE SPRAYERS FOR SPRAY OR FIRE PROTECTION**

Shoots up to 25'. Nickel plated brass barrel  
**GRE 61224 - adjustable gun and grip • 2.6 lbs.**



BACKPACK SPRAYERS/ CF VALVES

### **Stainless Steel Sprayer**

An attractive alternative for a variety of spraying tasks. Perfect for pesticides, herbicides, and many harsh chemicals.

- Corrosion resistant stainless steel tank
- Extra large T-style handle allows two-handed pumping
- 28" Durable brass wand and brass adjustable nozzle
- 48" Reinforced nylon hose provides extended reach
- Multiple nozzles included: flat fan, jet stream, hollow cone, and brass adjustable nozzle

**SOL 465** Stainless Steel Sprayer



### **CFValve™ Constant Flow Valve**

Spray the precise amount of chemical with the addition of a CFValve™ to the delivery system of a backpack, hand held, compression, 12V or field sprayer. Both the flow and pressure are controlled and, additionally, the flow is shut off when the pressure drops below the pre-set feature of the valve. The valve must be ordered by thread size and pressure range. Weight= .1 lb. each.

See chart below for thread and pressure range.

Use YELLOW & RED valves in backpack and compression sprayers.

Use GREEN & BLUE valves in 12V/ on-demand systems, boom sprayers or engine driven pumps

Back Pack Sprayer Model	YELLOW 14.5 PSI	RED 21 PSI	BLUE 29 PSI	GREEN 43.5 PSI
Solo, Lesco, any 3/8 BSP thread	SOL Y 3/8 BSP	SOL R 3/8 BSP	SOL B 3/8 BSP	SOL G 3/8 BSP
Hudson, Jacto, SP, any Spraying Systems component thread	GRE 98661V	GRE 98662V	GRE 98663	GRE 98664
Field King, Hardi, Maruyama	SOL Y 18 mm	SOL R 18 mm	SOL B 18 mm	SOL G 18 mm
Chapin, Birchmeier, B & G	GRE 98665	GRE 98666	GRE 98667	GRE 98668

# SOLO Knapsack Sprayers



4 gallon piston pump  
SOL 425

5 gallon piston pump  
SOL 435

4 gallon diaphragm pump  
SOL 475

5 gallon diaphragm pump  
SOL 485



3 gallon diaphragm pump  
SOL 473D



3 gallon piston pump  
SOL 473P



piston  
diaphragm  
pump



## Features:

- UV resistant, high density polyethylene tanks, commercial grade wands, nozzles, hoses, & valves
- Chemical resistant Viton® seals.
- Pump on the go feature: pump while on your back
- 4 nozzle assortment
- Left or right hand pump handle.

**SOL 425** - 4 gallon piston pump, 90 PSI • 11 lbs.

**SOL 425DLX** - 4 gallon piston pump deluxe package includes folding handle, pressure gauge, relief valve in tank and brass adjustable nozzle • 11 lbs.

**SOL 435** - 5 gallon piston pump • 14 lbs.

**SOL 475** - 4 gallon diaphragm pump, 60 PSI • 11 lbs.

**SOL 475DLX** - 4 gallon diaphragm pump and same features as 425DLX • 11 lbs.

**SOL 485** - 5 gallon diaphragm pump • 14 lbs.

**SOL 473D** - 3 gallon diaphragm pump • 11 lbs.

**SOL 473P** - 3 gallon piston pump • 11 lbs.

## Compression Style Sprayers

- Easy fill funnel top
- High capacity pump for quick pressurization
- 48" hose and 28" wand
- 4 nozzle assortment
- Pressure relief valve
- Large second opening for cleaning



**SOL 430-1G**  
1 gallon • 3 lbs.

**SOL 430-2G**  
2 gallon • 4 lbs.

**SOL 430-3G**  
3 gallon • 5 lbs.

## Common parts and accessories

Part #	Description	Fits
SOL 0610406-K	Diaphragm Pump Repair Kit	475, 485, 473D
SOL 0610407-K	Piston Pump Repair Kit	425, 435, 473P
SOL 0610410-P	Brass Adjustable Nozzle Kit	All
SOL 4800170	Shut-off Valve	All
SOL 4900170N	28" Universal Wand Assembly	All
SOL 4900356	Pressure Gauge	All
SOL 4900405-K	Pump Repair Kit	454, 456, 457
SOL 4900421	20" Brass Wand	All
SOL 4900430	Drift Guard	All
SOL 4900527	Plastic Adjustable Nozzle	All
SOL 4900528	60" Brass Wand	All
SOL 4900626	Pro-Spot Drift Guard	All
DBS 1085	Drift Guard	SCC 11/16 thread

BACKPACK SPRAYERS/SOLO/OSATU/SP

## OSATU Star 16 Green Knapsack Sprayer

The advanced design of this simple, highly functional unit makes it very light. It has fewer parts due to so many components being built-in. This makes it highly durable and a guaranteed product, and at the same time ensures maximum economy.

- Mechanical agitation helps to keep wetttable powders in suspension
- Internal tank reinforcement via ribbing between the walls, making the unit stronger and more deformation-resistant
- Has a handle for transport
- Reversible

**TRU Star-16-Green** • 7 lbs.



**NEW**

## SP Systems SP507 Gravity Tank

4 gallon tank with straps and gravity outlet. No pump. Use for sucker control in tobacco or other applications where low pressure gravity flow is needed.

**SP SP507** • 7 lbs.



**NEW**

## SP Systems EcoScape

- Fold back tubular handle for easy storage - Ergonomic design
- Piston - external pump capable of 120 PSI
- 6" wide mouth lid
- 4 gallon blow molded tank with Viton Seal
- Shoulder straps with rubber pads
- Adjustable plastic nozzle
- Fiberglass wand

**SP ECOSCAPE** • 11 lbs.



**NEW**



## SPRAY-HOOD APPLICATORS

Conservation Spray Hood design permits herbicide treatment of row middles and between plastic mulch inside a spray hood. Available in kit form or toolbar sprayer design.

**Hoods available individually or in kits to adapt to your tool bar: conservation, lay by, broadcast and over row**

**Specialty drift proof orchard and vine boom models available. Contact us for details.**

### VARIOUS SPRAY HOOD STYLES AND MOUNTS



Conservation

Lay by

Broadcast

Over row



## Hose-Fed and Electric Walk Sprayers

### Hose-Fed Sprayer

- Durable, lightweight aluminum and poly construction
- Patented airfoil technology
- Easy to use valve on handle with quick connect camlock fitting



WG3

- ROG WG3** - 36" spray width, 3 spray nozzles, flow indicator
- ROG WG4** - 48" spray width, 4 spray nozzles, flow indicator
- ROG WG6** - 72" spray width, 6 spray nozzles, flow indicator

### Electric Walk Sprayer



WE3



WE6

- Lightweight aluminum frame with poly hood for durability
- 12 volt pump with tray for battery

- ROG WE3** - 36" spray width, 3 spray nozzles, flow indicator
- ROG WE4** - 48" spray width, 4 spray nozzles, flow indicator
- ROG WE6** - 72" spray width, 6 spray nozzles, flow indicator



Controls vegetative growth by applying super heated water to non-selectively eradicate unwanted plants. The machine heats water on demand under low pressure. The very hot water immediately destroys the cellular structure of the plant. This method provides a non-chemical method of vegetation control keeping in mind concerns for human and environmental safety.



Aquacide® skid mounted 5.5 HP Honda, 3 GPM pump, 50' application hose, 12" wide four nozzle head and 6" wide two nozzle head applicator. Water reservoir supplied optional.

### ECO355

Aquacide® skid mounted, 6.5 HP, 6GPM, 50' application hose, 12" wide, four nozzle head applicator, 6" wide two nozzle head applicator.

### ECO655

WEED CONTROL/SPRAY HOODS



## WHY SPRAY BARE GROUND WHEN YOU CAN TARGET ONLY WEEDS?

Weed Seeker® Saves Up To 80% Of Chemical Cost. Precision Automated Spot Spraying Day Or Night



Weed Seeker® detects chlorophyll in plants. Comparing reflected light patterns, Weed Seeker® detects the difference between weeds, pavement or dirt. Weed Seeker® then delivers the precise amount of herbicide ONLY where it is needed - on the weed.

Technology provides the ability of a sensor to distinguish a plant from everything else by analyzing the specific light spectrum of green plants. The sensor "knows" when to spray by sensing a green plant. The machine simply turns on a spray valve when a plant is recognized and turns off the valve if no plant is present. This technology can be adapted to many sprayers and booms.

WeedSeeker® has two primary markets, agricultural and industrial. It can be used day or night because it has its own light source.

### 463 Weedseeker



**NEW**



**Hand Held CDA Sprayer**

The Volpi M3000 is an economical alternative to other more expensive controlled droplet applicators. Designed for the small grower or homeowner, the M3000 utilizes a spray shield to protect your crop. Requires 2 "D" batteries (not supplied).

This ultra low volume hand held sprayer for use with RoundUp® or other herbicides with little or no water, based on product labeling. With a 1 liter chemical container this lightweight sprayer can go a long way on a small amount of chemical. Only weighs 2 lbs. empty.

**VOL M3000** - Hand held CDA sprayer • 2 lbs.

## MANKAR

For orchards, Christmas trees, small fruits, vineyard, greenhouses, vegetables and landscapers. Mankar herbicide sprayers are shrouded, spinning disc sprayers designed for controlled droplet application (CDA) of herbicides in narrow bands. They give huge savings in application volume, time and effort when compared to hydraulic sprayers. They save time and costs for the applicator. The control of the spray droplet size and downward projection together with the hood minimizes spray drift.



### Mini Mantra Plus

insert shows Mini Mantra Plus head detail

#### Features:

- 1 quart of undiluted Roundup® will cover approximately 1 1/4 acres
- Adjustable flow rate
- Powered by rechargeable battery
- Mini Mantra Plus head rotates 90° for band width coverage
- 110 panel GP have adjustable spray hood 28" – 44" wide
- Spare parts available
- Rechargeable battery and charger supplied
- Battery lasts 8 hours

**MNK 100300**



### CYLINDRICAL SPONGE APPLICATOR

**NO DRIPPING OR DRIFT!**

There are many Super Sponge® models and sizes to choose from!

Call for information

Each complete Super Sponge® comes with:

- Heavy-duty, steel frame
- Corrosion-resistant plumbing
- Protective netting for the sponges
- Tank shut-off and stainless steel filter screen
- Translucent tank
- Sight glass manifolds that allow precise flow metering
- Made by Smuckers manufacturing



### SUPER SPONGE® KITS

Super Sponge® is also available in kit form. Each kit comes complete with plumbing, sponges and tank. All you supply are the wheels and frame! 5', 10' and 15' sizes.

## SIDESWIPE™

WIPES OUT YOUR WEEDS

The original hand-held herbicide wipe-on applicator is easier than hoeing and safer than spraying; designed to apply systemic herbicides only where you need them, **on the weeds**. Sideswipe's™ patented design delivers just enough chemical to do the job.

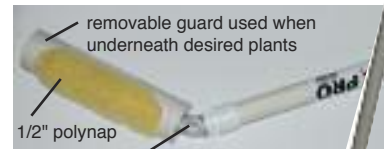

removable guard used when underneath desired plants

1/2" polynap

reversible clear plastic elbow provides 180° rotation of pad for new wiping area

Whether you are a professional grower or a weekend gardener Sideswipe™ has a place in your weed control program.

The Sideswipe™ applicator has many unique features that make it superior to competitive applicators.

- Convenient, easy to use
- Puts the herbicide where you want it
- No drift - usable on a windy day
- No leaching
- Unique nylon nap pad wets evenly every time
- All parts are replaceable and available as parts
- Not for use with oil based products.

#### Design details:

- Reservoir handle - 1 qt. capacity, 52" handle
- Nose threaded fitting allows insertion of shut-off valve
- Reversible clear plastic elbow indicates fluid level & gives 180° rotation of pad for new wiping area & longer pad life
- 1/2" polyester nap wiper pad with auto feeding
- Protective shield for wiping underneath desirable plants

**SID THS200** - 6" Sideswipe • 1.2 lbs.

**SID TH204** - 6" replacement pad • .5 lbs.

**SID THS100** - 9" Sideswipe • 1.4 lbs.

**SID TH104** - 9" replacement pad • .5 lbs.

WEED CONTROL



**FMC/JOHN BEAN PISTON PUMPS**

These pumps were made under the two names of FMC and Bean. We service, sell and stock parts for these pumps, old and new models.

**SALES - SERVICE - PARTS**  
for FMC/John Bean Pumps



**UDOR DIAPHRAGM & GAMMA SERIES**

**PLUNGER PUMPS AND ACCESSORIES**

**SALES - SERVICE - PARTS** available



**WP-1000 PORTABLE PUMP**

Good for tank filling, maple sap, garden or small plot irrigation.



- Echo 21.2 cc engine with Pro-Fire™ Electronic Ignition
  - Cast iron volute
  - Ideal for around-home use - draining pools, pool covers, irrigating lawns and gardens
  - Discharges up to 28 gal/min., 1680 gal/hr
  - Unit complete with suction hose and strainer
- ECH WP-1000** • 11.9 lbs.



**FRAME MOUNTED CENTRIFUGAL PUMPS**

Special models available. ALL parts available for ACE pumps. Contact us for specifications on pumps.



**ACE FMC-CW-150**

Cast iron, 1 1/2" suction x 1 1/4" discharge, clockwise rotation

**ACE FMC-CW-200**

Cast iron, 2" suction x 1-1/2" discharge, clockwise rotation

**ACE FMC**

Cast iron, 1 1/4" suction x 1" discharge, counter-clockwise rotation

**ACE FMC-150**

Cast iron, 1 1/2" suction x 1 1/4" discharge, counter-clockwise rotation

**ACE FMC-200**

Cast iron, 2" suction x 1 1/2" discharge, counter-clockwise rotation

**Call for other model number specifications**



**DIAPHRAGM & PLUNGER PUMPS**



**SALES, SERVICE and PARTS** available for Comet Pumps



**PUMP ADAPTERS**

Solid Steel Push Pin Design

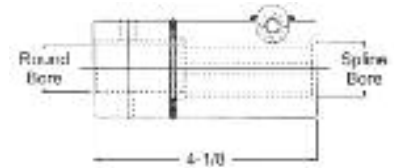

Stock Number	Spline Bore	Round Bore	Keyway Size	Wt. Lbs.
GAG 114-1000	1 3/8x6	5/8	3/16	2.13
GAG 114-1200	1 3/8x6	3/4	3/16	2.07
GAG 114-1400	1 3/8x6	7/8	3/16 & 1/4	2.00
GAG 114-1500	1 3/8x6	15/16	1/4	1.94
GAG 114-1600	1 3/8x6	1	1/4	2.00



**2" Self-priming Polypropylene Transfer Pump**

With 3 vane impeller, powered by 5.5 HP PowerPro gas engine with low oil sensor. .150 GPM - max.

**HYP 1542P-55SP** • 49 lbs.



**2" PUMP HOSE COMBO KIT**

Includes suction strainer, Two 2" nipples, a 2" x 20' suction hose and a 2" x 25' discharge hose. Tough PVC hoses have male and female standard pipe thread couplings.

**GPM 108999** • 27 lbs.



**Hypro Quick Couplers (Female to Female)**

**HYP 1323-0072** - 13/8" PTO - 6 spline (I.D.), 15/16" Pump end (I.D.) forged steel, 540 RPM

**HYP 1323-0073** - 13/8" PTO - 21 spline (I.D.), 15/16" Pump end (I.D.) forged steel, 1000 RPM

**HYP 1323-0074** - 13/8" PTO - 6 spline (I.D.), 5/8" Pump end (I.D.) forged steel, 540 RPM

**HYP 1323-0075** - 13/8" PTO - 21 spline (I.D.), 5/8" Pump end (I.D.) forged steel, 1000 RPM



**2" Self-priming Aluminum Transfer Pump**

Powered by a 4 HP Honda GX120 gas engine with oil alert. Mounted in a protective cage. .145 GPM - max.

**HYP 1572-SPX** • 55 lbs.



**Myers Myers-Aplex Piston Pumps**

Built for field serviceability. Continuous splash lubrication. Pressures up to 800 P.S.I and flows to 60 G.P.M. Ceramic coated cylinders for durability.

**SALES • SERVICE • PARTS** for old and new Myers pumps



**ESCO, Inc. has parts for sprayers and pumps ... plus used and recycled parts in stock for immediate delivery.**

**If you don't see it here, call us and we'll find it!**

PUMPS/COUPLERS

OESCO, Inc. is the  
Northeast Distributor  
for Hypro.

Call one of our pump  
specialists for your parts &  
service needs.

**Hypro**®  
**PUMPS**

**PISTON PUMPS**

**ROLLER PUMPS**

MODEL	MAX GPM	MAX PSI	MAX RPM	SHAFT INPUT
HYP 6500C	21.8	300	1200	5/8" solid shaft
HYP 6500N	21.8	300	1200	5/8" solid shaft
HYP 6500XL	21.8	300	1200	5/8" solid shaft
HYP 7560C	22.5	300	1200	15/16" solid shaft
HYP 7560N	22.5	300	1200	15/16" solid shaft
HYP 7560XL	22.5	300	1200	15/16" solid shaft
HYP 4001C	9.1	150	1800	5/8" solid shaft
HYP 4001N	9.1	150	1800	5/8" solid shaft
HYP 4001XL	9.1	150	1800	5/8" solid shaft



MODEL	MAX GPM	MAX PSI	MAX RPM	SHAFT INPUT
HYP 5315C-X	1.5	500	1800	5/8" OD solid shaft
HYP 5320C-X	2.2	500	1800	5/8" OD solid shaft
HYP 5325C-X	2.5	500	1800	5/8" OD solid shaft
HYP 5330C-X	3	500	1800	5/8" OD solid shaft
HYP 5315C-HX	1.5	500	1800	5/8" ID hollow shaft
HYP 5320C-HX	2.2	500	1800	5/8" ID hollow shaft
HYP 5325C-HX	2.5	500	1800	5/8" ID hollow shaft
HYP 5330C-HX	3	500	1800	5/8" ID hollow shaft
HYP 5206C	8	400	800	1" solid shaft w/base
HYP 5206C-H	8	400	800	1 3/8" hollow shaft w/base
HYP 5210C	10	400	600	1" solid shaft w/base
HYP 5210C-H	10	500	600	1-3/8" hollow shaft w/base



**DIAPHRAGM PUMPS**

MODEL	MAX GPM	MAX PSI	MAX RPM	PORT SIZE	SHAFT INPUT
HYP 9910-D252	6.1	290	650	1-1/4" HB inlet, 1" HB outlet	3/4" solid keyed shaft
HYP 9910-D252GRGI	6.1	290	2800	3/4" HB inlet, 3/8" HB outlet	3/4" hollow shaft
HYP 9910-D252GRGI58	5.5	290	3600	3/4" HB inlet, 3/8" HB outlet	5/8" hollow shaft

MODEL	MAX GPM	MAX PSI	MAX RPM	PORT SIZE	SHAFT INPUT
HYP 9910-D30	9	580	550	1-1/4" HB inlet, 1" HB outlet	Select Kit
HYP 9910-D30APA	Same pump as 9910-D30 with 3/4" solid thru shaft				Select Kit
HYP 9910-D30GRGI	9	580	3600	Assembled w/ gearbox 9910-KIT1640 and control 9910-GS40GI for mounting on 5HP gas engine	Select Kit
HYP 9910-D50	14	580	550	1-1/4" HB inlet, 1/2" HB outlet	Select Kit
HYP 9910-D50B	Same pump as 9910-D50 w/Buna-N diaphragms				Select Kit
HYP 9910-D50APA	Same pump as 9910-D50 w/solid thru shaft				Select Kit

MODEL	MAX GPM	MAX PSI	MAX RPM	PORT SIZE	SHAFT INPUT
HYP 9910-D70	19	290	550	1-1/4" HB inlet, 1" HB outlet	Select shaft kit for desired drive
HYP 9910-D115	30.1	290	550	1-1/2" HB inlet, 1" HB outlet	Select shaft kit for desired drive
HYP 9910-D135	34.8	290	550	1-1/2" HB inlet, 1" HB outlet	1-3/8" — 6 splined male shaft

MODEL	MAX GPM	MAX PSI	MAX RPM	PORT SIZE	SHAFT INPUT
HYP 9910-DBS140	37.8	725	550	1-1/2" HB inlet, 3/4" NPT outlet	1-3/8" — 6 splined male double-ended shaft
HYP 9910-DBS160	39.6	725	550		
HYP 9910-DBS200	49.7	725	550		



HYPRO PUMPS

**CENTRIFUGAL PUMPS**

MODEL	MAX GPM	MAX PSI	MAX RPM	SHAFT OUTPUT
HYP 9202C	103	170	6000	5/8" solid shaft
HYP 9203C	140	170	6000	5/8" solid shaft
HYP 9202S	103	170	6000	5/8" stainless steel shaft
HYP 9203S	140	170	6000	5/8" stainless steel shaft

MODEL	MAX GPM	MAX PSI	MAX RPM	PTO OUTPUT
HYP 9402C-540	76	95	600	1-3/8" female, 6-spline shaft
HYP 9402C-540Q	76	95	600	1-3/8", 6-spline Quick Coupler
HYP 9403C-540Q	140	104	600	1-3/8", 6-spline Quick Coupler
HYP 9403C-1000	140	104	1000	1-3/8" female, 21-spline shaft



*Here Are Some Of The Nozzles We Recommend For These Spraying Applications:*

For: Soil incorporation, pre-emergence, fertilizer (broadcast) use a coarse spray from Turbo Floodjet® and TurboTeeJet® induction nozzles.

For: Systemic herbicides, fungicides, insecticides use the same nozzles plus the TurboTeeJet® AIXR and AIC nozzles

For: Contact herbicides, fungicides, insecticides use Turbo TeeJet® or XR TeeJet®

## Turbo TeeJet® Wide Angle Flat Spray Tips Medium sized particles



- Tapered edge wide angle flat spray pattern for uniform coverage in broadcast spraying
- Large, rounded internal passage to minimize clogging
- Excellent resistance to corrosive solutions

- Large droplets for less drift - 15-90PSI
- Automatic spray alignment with 25612-\*NYR Quick TeeJet® cap and gasket

## XRC TeeJet® Extended Range Flat Spray Tips Medium sized particles



- Excellent spray distribution over a wide range of pressures - 15-60PSI (1-4 bar)
- Reduces drift at lower pressures, better coverage at higher pressures
- 80° available in stainless steel and ceramic

- 110° available in stainless steel, ceramic and polymer
- XR TeeJet® tip molded into Quick TeeJet cap provides automatic spray alignment
- Includes tightly fitting washer that stays put and assures a good seal.

## Turbo FloodJet® Wide Angle Flat Spray Tips Coarse particles



- Excellent spray distribution for uniform coverage along the boom
- Nozzle design incorporates a pre-orifice to produce larger droplets for less drift
- Large, round orifice reduces clogging

- Stainless steel or polymer with VisiFlo® color-coding band for easy size identification
- Can be used with CP25599-\*NY Quick TeeJet® cap for automatic alignment

## TeeJet® Disc-Core Type Full Cone Spray Tips



### Typical Applications:

For spraying pesticides at higher pressures and flow rates. Especially suitable for wettable powders and other abrasive chemicals. Larger capacity nozzles are also used in air blast sprayers.

## TeeJet® Disc-Core Type Hollow Cone Spray Tips

### Features:

- Produce smaller droplets for thorough coverage with contact pesticides and foliar applications.
- Maximum spray pressure to 300 PSI (20 bar).



*Available in a variety of materials including ceramic for increased wear life.*



4514-NY  
Slotted Strainer



Core



Disc

"Up until now, obtaining excellent drift resistance required a compromise. Tips that produce very coarse droplets do minimize drift but don't provide the same surface coverage as tips that produce smaller droplets. In some applications, inadequate coverage decreases the effectiveness of the applied chemicals. These new AIXR tips provide a perfect balance of drift control and coverage - precisely-sized, large, air-filled drops stay on target and cover the entire plant." - Spraying Systems

## AIXR TeeJet® Air Induction XR Flat Spray Tips • very coarse particles



- Made of a two piece UHMWPE polymer construction with VisiFlo® color-coding, UHMWPE provides excellent chemical resistance, including acids, as well as exceptional wear life

- 110° wide, tapered flat spray angle with air induction technology offers better drift management
- Compact size to prevent damage
- Depending on the chemical, produces large air-filled drops through a venturi air aspirator

- Removable pre-orifice
- Available in seven tip capacities with a wide operating pressure range: 15-90 PSI (1-6 bar)
- Automatic alignment when used with 25612-\* -NYR Quick TeeJet® cap and gasket

## AITX ConeJet® Air Induction Hollow Cone Spray Tip • coarse particles



- Ideal for drift control on airblast orchard sprayers
- Constructed of polypropylene, ceramic and Vitron® for excellent chemical and wear resistance
- Larger droplets are produced, as compared to standard TX ConeJet, through the use of a venturi air aspirator resulting in reduced drift and improved canopy penetration
- Removable pre-orifice for fast and easy cleaning

- Available in VisiFlo® ceramic (VK)
- AITX to be used with CP25607-\* -NY Quick TeeJet cap
- Suggested spray pressure of 60-300 PSI (4-20 bar)

## Turbo TeeJet® Induction Flat Spray Tip • extremely coarse particles



- 110° wide angle, air induction, tapered flat spray tip pattern based on the patented outlet orifice design of the original Turbo TeeJet® nozzle
- Patented orifice design provides large, round passages to minimize plugging
- Depending on the chemical, produces large air-filled drops through a venturi air aspirator resulting in less drift
- All polymer construction for excellent chemical and wear resistance
- Compact size to prevent tip damage

- Removable pre-orifice
- Ideal for use with automatic sprayer controllers
- Wide operating pressure range: 15-100 PSI (1-7 bar)
- Automatic alignment when used with 25598-\* -NYR Quick TeeJet® cap and gasket

## AIC TeeJet® Air Induction Flat Spray Tips • very coarse particles



- Produces a 110° tapered edge flat spray pattern for uniform coverage in broadcast spraying applications
- Available with a polymer insert with stainless steel (015-10 capabilities), ceramic (025-05 capabilities) or polymer (02-05 capabilities) inserts
- Larger droplets for less drift
- Depending on the chemical, produces large air-filled drops through the use of a venturi air aspirator
- AIC TeeJet® nozzle molded into Quick TeeJet® cap provides automatic spray alignment
- Includes tightly fitting washer that stays put and assures a good seal
- Recommended pressure rating 30-115 PSI (2-8 bar)

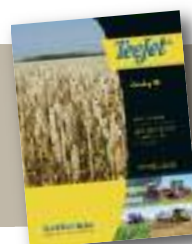

Request a free copy  
of the latest  
TeeJet Catalog

# GunJet® SPRAY GUNS

## Brass Model AA43 Series Guns A single hand operated spray gun

SSC AA43H-8 - 22" long, high pressure  
SSC AA43L-8 - 22" long, low pressure

SSC AA43HA-8 - 13" long, high pressure  
SSC AA43LA-8 - 13" long, low pressure

- Trigger control on/off
- Trigger pattern adjustment hollow cone to straight stream as you pull the trigger back
- Available low (200PSI) or high (700PSI) pressure operation
- Interchangeable discs for volume control (one disc supplied)
- 1/2 FPT inlet
- Brass or aluminum models - Special note: Brass available while supplies last
- Length of barrel available: AA43=22" long, AA43A=13" long
- Number 8 disc supplied with gun. Other discs available as optional equipment.



## GUNJET® LAWN SPRAY GUN

Model No.	Nozzle Tip #	Tip Color
SSC 25660-1.5	CP 25670-1.5 NY	Gray
SSC 25660-3.0	CP 25670-3.0 NY	Black
SSC 25660-4.0	CP 25670-4.0 NY	Red

Pressure measured at spray nozzle

## Other GunJet Spray Guns:

All below have a twist handle for on/off and adjustment of pattern. Two hand operation, replaceable disc for volume control. *Note: Specify disc when ordering gun*



SSC AA2 - 24" long - Brass 3/4" FHT Inlet - • 3.5 lbs.



SSC AA12 - 20" long - Brass 3/4" FHT Inlet - • 1.75 lbs.



SSC AA18-AL - 20" long - Aluminum 1/4" FPT Inlet - • 1 lb.

## Optional Accessories for GunJet® Spray Guns

SSC 7029 - Adapter for GHT (1/2 MPT to FGT) Brass  
SSC 11740B - Swivel connector with FHT. Free swiveling, leak proof  
SSC 11990-18 or SSC 11990-19 - 1/2 MPT Swivel connectors for 43 Series GunJet  
SSC AA-46 - Trigger Valve, aluminum attaches to 3/4 FHT on handle valves to convert to trigger valve (not pictured)



SSC 7029



SSC 11740B



SSC 11990

## TriggerJet® SPRAY GUN - MODEL 22670



Model	Extension Length	Inlet Connection
SSC 22670-PP-15-1/4	15"	1/4" (F)
SSC 22670-PP-15-300	15"	1/4" Hose Shank
SSC 22670-PP-15-406	15"	3/8" Hose Shank
SSC 22670-PP-24-1/4	24"	1/4" (F)
SSC 22670-PP-24-300	24"	1/4" Hose Shank
SSC 22670-PP-24-406	24"	3/8" Hose Shank

- Maximum pressure rating is 150 PSI (10 bar)
- 22670 TriggerJet® spray gun comes w/ choice of 1/4" or 3/8" hose shank or 1/4" NPT
- Choice of 15" or 24" lengths
- 38720-PPB-X8 adjustable ConeJet® spray tip with Viton® O-ring.
- Accepts all standard TeeJet® spray tips and tip strainers

SPRAY GUNS

### Valves

**4688 Trigger Valve** with trigger lock. Max flow rate 2 GPM, max pressure 250 PSI (10 bar). 1/4" NPT (F) inlet connection, 11/16"-16 (M) outlet connection. Brass material.  
**SSC 4688**



**6466 Trigger Valve** Same as 4688, less trigger lock, with extra long trigger.  
**SSC 6466**



### Handles

**4727 Sure Grip Handle**  
Brass, rubber coated, 1/4" NPS (M) or BSPT hose inlet connection.  
**SSC 4727**



**4754 Sure Grip Handle**  
Brass, rubber coated, 3/4" garden hose thread (F) inlet connection.  
**SSC 4754**



### Brass Extensions

Straight and curved extensions 4673 and 6671 - for pressure to 125 PSI (9 bar). 7715 - for pressure to 250 PSI (17 bar). Fits models 23L, 31 GunJet spray guns and trigger valves.

Straight w/ Fixed Body	Curved w/Swivel Body	Curved w/Fixed Body	Ext. Length	Net Weight in oz.
7715-8	4673-8	6671-8	8"	3
7715-18	4673-18	6671-18	18"	4
7715-24	4673-24	6671-24	24"	5
7715-30	4673-30	6671-30	30"	5 1/2
7715-36	4673-36	6671-36	36"	6 1/4
7715-48	4673-48	6671-48	48"	7 1/2

Tip - please specify

Cap CP1325

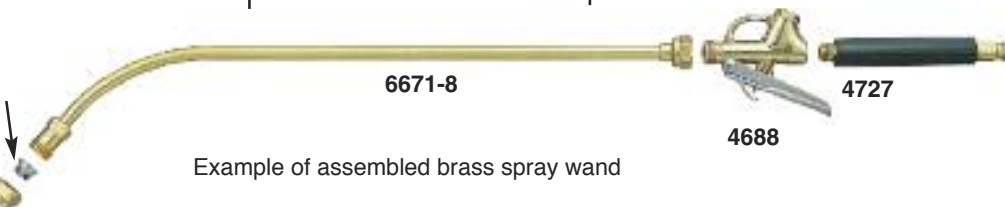

Example of assembled brass spray wand



Largest John Bean parts inventory in the Northeast!



ALL parts available for John Bean Sprayers, Accessories and Guns.

### JOHN BEAN 785 SPRAY GUN

Excellent all purpose spray gun. Aluminum construction, adjustable pattern, trigger control (with latch), interchangeable discs for volume control. Assortment of discs supplied with gun and optional large volume kit available. 24" long, 3/4" FGH inlet, 48 GPM, 800 PSI capacity.

JBS 5253228 • 5 lbs.

JBS 5254037 High volume kit (over 25 gpm)



### JOHN BEAN 757 SPRAY GUN

Nice aluminum constructed true pistol spray gun for one hand operation. Pattern adjustment, locking trigger, interchangeable discs for volume control. Assortment of discs supplied with gun. 11" long, 3/4" FGH inlet, 13 GPM, 600 PSI capacity.

JBS 1235000 • 1.5 lbs.

### Hypro® ADJUSTABLE PATTERN SPRAY GUNS



#### HYPRO LONG DISTANCE GUN

21" barrel, 30gpm flow, up to 1200psi, two handle. Spray gun 1/2" MPT inlet, Trigger valve.

HYP 3381-0011 • 6 lbs.



#### HYPRO TURBO GUN

7" barrel, up to 10gpm flow, up to 700psi, one hand operation, 1/2" MPT inlet trigger valve, pattern adjustment and a sliding cone over the tip to inject air for turbo mist.

HYP 3381-0013 • 1/4 lb.

### GREEN GARDE®

#### SPRAY GUN

This rugged stainless steel and brass pistol gun is barrel adjustable from fine cone spray to straight stream. Interchangeable tips and nozzles gives various patterns and volumes. The body is tapped 1/4 FPT with a plug for installation of a gauge for calibration purposes. Large trigger has locking clip. Length 7", 3/4" FHT inlet.



#### JD9-CT Standard Spray Gun

Supplied with Large tip (3.86 oz.) and manual adjustable pattern control, trigger is on/off

GRE 38501 • 2 lbs.

#### JD9-PT Spray Gun

Trigger on PT model controls on/off and variable spray pattern.

GRE 38507 • 2 lbs.



GRE 38507

### Accessories to Fit the JD9-CT gun

A	GRE 38633	Flooding Plastic	4 GPM
B	GRE 38634	Flooding Plastic	2 GPM
C	GRE 38635	Flooding Plastic	5 GPM
D	GRE 38636	Flooding Baseball Head	2 GPM
E	GRE 38637	Flooding Plastic	1 GPM
F	GRE 38638	Flooding Plastic	1/2 GPM

#### Spray gun tips:

No.	Size	Flow Rate	
G	GRE 38606	Extra Small	0.3 to 1 GPM
H	GRE 38605	Small	1.0 to 3 GPM
I	GRE 38604	Medium	2.0 to 5 GPM
J	GRE 38602	Large	3.0 to 8 GPM w/gun
K	GRE 38603	Extra Large	10 to 19 GPM

### Tip Adapters, Wands

GRE 38512 Tip adapter for use with Spraying Systems Co. wands

GRE 38990 Tip adapter for use with Hudson spray wands or with Calibrator™ valve

GRE 38545 Hudson straight 18" brass spray wand with Delavan Raindrop Low Drift RF8 nozzle

GRE 38546 Hudson curved 18" brass spray wand with Delavan Raindrop Low Drift RF8 nozzle

### Hamilton Senior Brass Spray Gun

Heavy duty brass spray gun. 900 PSI maximum pressure. All orifice discs are made from hardened steel. Inlet: 3/4" FGHT. Comes with #5 disc. 22" OAL.



HAM 1000-01

**NEW**



### HEAVY DUTY ROOT FEEDER

Pressure feed from 2-10" deep. 7" & 11" extensions available for probing. Rugged, long-lasting design.



CALL FOR OTHER FEEDER ACCESSORIES AND MODELS

GRE 38919 - Heavy-duty feeder with 38917

2-hole tip complete - Gun sold separately.

GRE 38918 - 3-hole tip only

GRE 38901 - 4-hole tip only

GRE 38906 - 7" stainless steel needle extension w/O-rings

GRE 38907 - 11" stainless steel needle extension w/O-rings

GRE 38908 - 36" extension

GRE 38903 - 18" extension

GRE 38905 - Floppy foot plate

GRE 38904 - Extension connector w/O-rings

OESCO assembles specialty guns for use by growers, in greenhouses or to spray tobacco.

Call us for your special high or low pressure spray gun needs.

SPRAY GUNS



**Model 6815**

<i>PISTON TYPE</i>	Valve #	Recommended Pressure Range	Inlet & Outlet Pipe Connection Size	Net Weight
<b>MODEL 6815</b> • Brass with stainless steel springs • Models with light spring (50psi) for use with XR TeeJet® and LP TeeJet® tips and other low pressure systems • Use HSS models for longer lasting valve	SSC 6815-1/2-50	Up to 50 psi	1/2" NPT	1 1/4 lbs.
	SSC 6815-1/2-300	Up to 300 psi		
	SSC 6815-1/2-700	300 - 700 psi		
	SSC 6815-3/4-50	Up to 50 psi	3/4" NPT	
	SSC 6815-3/4-300	Up to 300 psi		
	SSC 6815-3/4-700	300 - 700 psi		
	SSC 6815-1/2-HSS-300	Up to 300 psi	1/2" NPT	
	SSC 6815-1/2-HSS-700	300 - 700 psi	3/4" NPT	
	SSC 6815-3/4-HSS-300	Up to 300 psi		
	SSC 6815-3/4-HSS-700	300 - 700 psi		

**Model 8460**



<i>DIAPHRAGM TYPE MODEL 8460</i>	Valve #	Inlet & Outlet Pipe Connection Sizes	Rec. Pressure Range	Net Weight
Nylon inlet body with aluminum bonnet. Choice of 1/2" or 3/4" NPT (M) inlet and (F) outlet connections. Flow rates to 70 GPM for 3/4" size. Pressures to 50 & 300 psi.	SSC 8460-1/2-50	1/2" NPT	Up to 50 psi	14 oz.
	SSC 8460-3/4-50	3/4" NPT	Up to 50 psi	14 oz.
	SSC 8460-1/2	1/2" NPT	Up to 300 psi	14 oz.
	SSC 8460-3/4	3/4" NPT	Up to 300 psi	14 oz.



**Model 23120**

<i>MODEL 23120</i>	Valve #	* Inlet & Outlet Pipe Connection Sizes	Pressure Range	Net Weight
302 stainless steel spring and EPDM O-ring. Excellent chemical resistance. 1/4" port for pressure gauge pipe plug included. Polypropylene.	SSC 23120-*PP	1/2" or 3/4"	150 PSI (10 bar)	8 oz.
	SSC 23120A-*PP	1/2" or 3/4"	150 PSI (10 bar)	8 oz.

**ALSO AVAILABLE SPECIAL ORDER** - Models for high pressures up to 1200 psi

RELIEF/CONTROL VALVES

**6B DIRECTOVALVE®**



- Molded of corrosion-resistant materials, all wetted parts are polypropylene, stainless steel and polyethylene
  - Maximum pressure of 150 PSI
  - Large capacity, 12 GPM at 5 PSI pressure drop
  - Molded-in mounting flange and 1/4" NPT gauge port
  - 3/4" inlet 1/2" boom connection
- SSC AA6B**

**AA17 TEE VALVE® CONTROL VALVE**

- 
- Raise lever to open, lower to close valve
  - Aluminum construction with corrosion resistant internal parts
  - Lift off poppet valves for positive ON-OFF action
  - Cam type index tip assures exact position of valve
  - Dimensions: 4" wide x 4 1/2" high x 5" deep (not including handle)
  - Weight 2 3/4 lbs.



**High Pressure and High Flow Valves**

**JBS 1207620**

50-800 psi, 40 GPM Capacity  
3/4" Threads  
Height: 9 1/2" • Weight: 8 lbs.



**JBS 5284368**

50-1000 psi, 75 GPM Capacity  
1 1/4" Threads  
Height: 9 1/2" • Weight: 7 lbs.



**JBS 5284450**

50-1200 psi, 75 GPM Capacity  
1 1/4" Threads  
Height: 12 1/8"  
Weight: 10.5 lbs.

**HAMILTON BYPASS AND RELIEF VALVES**



Compact brass valve has spring and stainless steel ball for valve. Tee handle with locking nut to set pressure. Available in 1/2" and 3/4" MPT and spring range 0 - 300 PSI or 0 - 600 PSI. Bypass connector 1/2 or 3/4" FPT.

**HAM 2041-01** • 1/2" NPT, 0-600 PSI • 1 lb.

**HAM 2042-01** • 1/2" NPT, 0-300 PSI • 1 lb.

**HAM 2053-01** • 3/4" NPT, 0-300 PSI • 1 lb.

**HAM 2054-01** • 3/4" NPT, 0-600 PSI • 1 lb.

**MODEL 17L**

**Connections:**

- 1/4" NPT pressure gauge port
- Inlet: 3/4" NPT
- Boom outlets: 3/4" NPT (3)
- Accessory outlets 3/4" NPT (2)

**SSC AA17L**

**MODEL 17Y**

**Connections:**

- 1/4" NPT pressure gauge port
- Inlet: 1" NPT
- Boom outlets: 3/4" NPT (3)
- Accessory outlets: 3/4" NPT (2)

**SSC AA17Y**

**ALL PARTS AVAILABLE FOR JOHN BEAN VALVES**



**Plastic Valves & Fittings**  
PVC molded-in place ball valves. Low cost, quarter-turn operation. Maintenance free, corrosion-free. Used with water plumbing for industrial, agricultural and residential

(NSF Approved) purposes. Can also be used in the chemical supply line for waste water treatment as well as chemical plants.

PART #	NPT SIZE
FLO 6Q-MTWE050	1/2" FNPT
FLO 6Q-MTWE075	3/4" FNPT
FLO 6Q-MTWE100	1" FNPT
FLO 6Q-MTWE125	1 1/4" FNPT
FLO 6Q-MTWE150	1 1/2" FNPT
FLO 6Q-MTWE200	2" FNPT



KINGSTON

**QUICK OPEN SELF CLOSE VALVES**

Normally closed, quick open, self closing valve, heavy brass construction. Stem design has pressure equalization across stem seat to allow for high pressure operation. Disc seat and O-ring seals with stainless steel springs. Maximum pressure 400 PSI. Handles available with squeeze, pull, or lift levers (also available without lever and bracket.) Excellent for agricultural or industrial sprayers. 1/2", 3/4", 1", and 1 1/4" sizes.

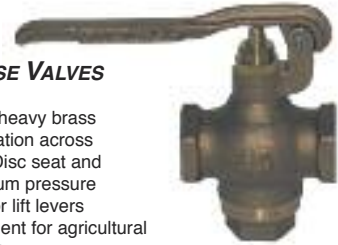

**Quick Open to 150 PSI - squeeze lever    Above 150 PSI - squeeze lever**

KIN 305A-4-1	1/2" • 2 lbs.	KIN 305B-4-1	1/2" • .5 lb.
KIN 305A-5-1	3/4" • 2.5 lbs.	KIN 305B-5-1	3/4" • .75 lb.

KIN 305B-FF-5-KIT - Kit for 3/4" high pressure valve

KIN 305A-FF-5-KIT - Kit for 3/4" low pressure valve

Call for information on other sizes and handle styles

**PLASTIC BALL VALVES  
SERIES 226**

Barb x Barb MODEL	END CONN.	END CONN.	MAX PRESSURE
SMC FN-226-4B4B-E	1/4" BARB	1/4" BARB	125
SMC FN-226-6B6B-B	3/8" BARB	3/8" BARB	125
SMC FN-226-8B8B-B	1/2" BARB	1/2" BARB	125
<b>Pipe x Barb</b>			
SMC FN-226-4B4M-E	1/4" M.N.P.T.	1/4" BARB	125
SMC FN-226-4M6B-E	1/4" M.N.P.T.	3/8" BARB	125
SMC FN-226-8B4M-B	1/4" M.N.P.T.	1/2" BARB	125

**BRASS BALL VALVES  
1/8" - 3/4"**

PART #	END CONN.	END CONN.
SMC 012-2F2M-BT	1/8" F.N.P.T.	1/8" F.N.P.T.
SMC 025-4F4F-BT	1/4" F.N.P.T.	1/4" F.N.P.T.
SMC 036-6F6F-BT	3/8" F.N.P.T.	3/8" F.N.P.T.
SMC 025-4F4M-BT	1/4" F.N.P.T.	1/4" M.N.P.T.
SMC 025-4F4B-BT	1/4" F.N.P.T.	1/4" HOSE BARB
SMC 025-4FMN-BT	1/4" F.N.P.T.	11/16"-16 MALE THRD.
SMC 025-4MMN-BT	1/4" M.N.P.T.	11/16"-16 MALE THRD.
<b>SMC 075-FG-BT</b>		
SMC 075-HG-BT	3/4" F.N.P.T.	3/4" M.G.H.T.
	3/4" F.G.H.T.	3/4" M.G.H.T.

**BRAGLIA VALVES**

High pressure, 12 volt, ball valves and pressure regulators. Low cost, low maintenance and compact design makes them perfect for new and old sprayer retrofits.

**REA 180.1910.9** - 12V ball valve  
**REA 180.1910.10** - 12V pressure regulator

**Apollo Valves**

High pressure, 600 PSI 1/4 turn bronze valves, stainless ball teflon seats.

**3 way Valves**

APO 70-603-01 - 1/2" FNPT  
APO 70-604-01 - 3/4" FNPT  
APO 70-605-01 - 1" FNPT  
APO 70-606-01 - 1 1/4" FNPT  
APO 70-607-01 - 1 1/2" FNPT  
APO 70-608-01 - 2" FNPT

High pressure, 600 PSI 1/4 turn bronze valves, stainless steel and stem teflon seats.

**2 way Bronze Ball Valves**

APO 71-144-01 - 3/4" FNPT  
APO 71-145-01 - 1" FNPT  
APO 71-146-01 - 1 1/4" FNPT  
APO 71-147-01 - 1 1/2" FNPT

**Economical Medium Pressure**

400 PSI, 1/4 turn bronze valve, stainless steel ball, teflon seats.

APO 32-101-01 - 1/4" FNPT	APO 32-105-01 - 1" FNPT
APO 32-102-01 - 3/8" FNPT	APO 32-106-01 - 1 1/4" FNPT
APO 32-103-01 - 1/2" FNPT	APO 32-107-01 - 1 1/2" FNPT
APO 32-104-01 - 3/4" FNPT	APO 32-108-01 - 2" FNPT



**AA144P DIRECTOVALVE®**

**2-WAY ELECTRICALLY CONTROLLED SOLENOID VALVE**

- 10 GPM (37.9 l/m) flow with only 5 PSI (0.35 bar) pressure drop
- 2.5 amp current draw
- Polypropylene body for chemical resistance
- Fabric reinforced Viton® diaphragms
- No stroke adjustment required
- Corrosion resistant. 430SS solenoid grade armature and armature stop
- Encapsulated coil and magnetic circuit

Model #	Inlet Size	Outlet Size
SSC AA144P-*	3/4"	1/2"

\*To order, specify AA144P- then "1", "2", or "3" to indicate number of units.  
**Example: AA144P-3**

**TEEJET 344BEC ELECTRIC 12V VALVE**

- 25 RPM, .6 second shut-off fully open to close
  - Available in 2-way or 3-way versions
  - Stainless stem with optional polypropylene or stainless steel ball
  - Maximum pressure 300 PSI
  - Flow rate 24-32 GPM depends on style of valve
  - Wetted parts are nylon, Teflon®, polypropylene, stainless steel and Vitron®
  - Available in 3/4" or 1" connections
- SSC 344BEC**



ELECTRIC AND MANUAL VALVES



## POLYPROPYLENE BALL VALVES

4 bolt construction (6 bolt for large valves) with viton O rings and teflon seats. 100 PSI max pressure.



### 4 Bolt Valves

Part #	Description	Max PSI	Pipe Size	Thru Ball
BJO V050	Full Port	150	1/2"	3/4"
BJO V075	Full Port	150	3/4"	3/4"
BJO V100	Standard Port	150	1"	3/4"
BJO V100FP	Full Port	150	1"	1"
BJO V125	Standard Port	150	1 1/4"	1"
BJO V125FP	Full Port	150	1 1/4"	1 1/2"
BJO V150	Full Port	150	1 1/2"	1 1/2"
BJO V200	Standard Port	150	2"	1 1/2"

### 6 Bolt Valves

Part #	Description	Max PSI	Pipe Size	Thru Ball
BJO V200FP	Full Port	150	2"	2 1/16"
BJO V300	Standard Port	100	3"	2 1/2"
BJO V300FP	Full Port	100	3"	3"

## SINGLE UNION POLYPROPYLENE BALL VALVES

- Precision molded in glass reinforced polypropylene, for strength and chemical resistance
- Maximum operating pressure 100 psi at 70° F.

Part #	Description
BJO UV075FP	3/4" Single Union Poly Valve
BJO UV100FP	1" Single Union Poly Valve
BJO UV125FP	1 1/4" Single Union Poly Valve
BJO UV150FP	1 1/2" Single Union Poly Valve



## BANJO STUBBY VALVES

2" Standard Port, Ball Valves with 1.5" Ball Opening

- Stainless steel bolts
- Glass filled polypropylene
- Multiple design options
- Unique patented compact design
- Lightweight
- Maximum operating pressure 100 psi @ 70° F. 75 psi @ 150° F.
- All PTFE Seals



Part #	Description
BJO VSF200	2" Male Adaptor X 2" Female NPT
BJO VSFMT200	2" Male Adaptor X 2" Male NPT
BJO VSFHB200	2" Male Adaptor X 2" Male Hose Barb

Many other Banjo valves available - Call for details

## Hypro®

### Bulkhead Fittings

(For all tanks – poly, wood, steel)



Part#	Size
HYP WBH12	1/2" NPT
HYP WBH34	3/4" NPT
HYP WBH100	1" NPT
HYP WBH114	1 1/4" NPT
HYP WBH112	1 1/2" NPT
HYP WBH200	2" NPT
HYP WBH300	3" NPT
HYP WBH400	4" NPT



## POLYPROPYLENE PIPE FITTINGS

### Poly Nipples

Part #	Description
BJO NIP050-SH	1/2" x Short Poly Nipple
BJO NIP075-SH	3/4" x Short Poly Nipple
BJO NIP075-4	3/4" x 4" Poly Nipple
BJO NIP075-6	3/4" x 6" Poly Nipple
BJO NIP100-SH	1" x Short Poly Nipple
BJO NIP100-4	1" x 4" Poly Nipple
BJO NIP100-6	1" x 6" Poly Nipple
BJO NIP125-SH	1 1/4" x Short Poly Nipple
BJO NIP125-4	1 1/4" x 4" Poly Nipple
BJO NIP125-6	1 1/4" x 6" Poly Nipple
BJO NIP150-SH	1 1/2" x Short Poly Nipple
BJO NIP200-SH	2" x Short Poly Nipple
BJO NIP200-6	2" x 6" Poly Nipple

### Reducing Bushing

Part #	Description
BJO RB125-075	1 1/4" MPT x 3/4" FPT Red. Bush.
BJO RB125-100	1 1/4" MPT x 1" FPT Red. Bush.
BJO RB150-075	1 1/2" MPT x 3/4" FPT Red. Bush.
BJO RB200-075	2" MPT x 3/4" FPT Red. Bush.
BJO RB200-100	2" MPT x 1" FPT Red. Bush.
BJO RB200-150	2" MPT x 1 1/2" FPT Red. Bush.

### Poly Pipe Tee

Part #	Description
BJO TEE050	1/2" Poly Pipe Tee
BJO TEE075	3/4" Poly Pipe Tee
BJO TEE100	1" Poly Pipe Tee
BJO TEE125	1 1/4" Poly Pipe Tee
BJO TEE150	1 1/2" Poly Pipe Tee
BJO TEE200	2" Poly Pipe Tee

### Poly Elbows 90°

Part #	Description
BJO EL075-90	3/4" Poly Pipe Elbow 90°
BJO EL100-90	1" Poly Pipe Elbow 90°
BJO EL125-90	1 1/4" Poly Pipe Elbow 90°
BJO EL150-90	1 1/2" Poly Pipe Elbow 90°
BJO EL200-90	2" Poly Pipe Elbow 90°

### Poly Street Elbows 90°

Part #	Description
BJO SL075-90	3/4" Pipe Street Elbow 90°
BJO SL100-90	1" Pipe Street Elbow 90°
BJO SL125-90	1 1/4" Pipe Street Elbow 90°
BJO SL150-90	1 1/2" Pipe Street Elbow 90°
BJO SL200-90	2" Pipe Street Elbow 90°

### Poly Street Elbows 45°

Part #	Description
BJO SL125-45	1 1/4" Poly Pipe Street Elbow 45°
BJO SL150-45	1 1/2" Poly Pipe Street Elbow 45°
BJO SL200-45	2" Poly Pipe Street Elbow 45°

## POLYPROPYLENE HOSE BARBS

### Poly Straight Hose Barbs

Part #	Description
BJO HB050-075	1/2" Male Thread x 3/4" HB
BJO HB075	3/4" Male Thread x 3/4" HB
BJO HB100	1" Male Thread x 1" HB
BJO HB100-075	1" Male Thread x 3/4" HB
BJO HB100-125	1" Male Thread x 1 1/4" HB
BJO HB125	1 1/4" Male Thread x 1 1/4" HB
BJO HB150	1 1/2" Male Thread x 1 1/2" HB
BJO HB150-125	1 1/2" Male Thread x 1 1/4" HB
BJO HB150-200	1 1/2" Male Thread x 2" HB
BJO HB200	2" Male Thread x 2" HB
BJO HB200-155	2" Male Thread x 1 1/2" HB

### Poly 90° Hose Barbs

Part #	Description
BJO HB050/075-90	1/2" Male Thread x 3/4" HB 90°
BJO HB075-90	3/4" Male Thread x 3/4" HB 90°
BJO HB100-90	1" Male Thread x 1" HB 90°
BJO HB100/125-90	1" Male Thread x 1 1/4" HB 90°
BJO HB125-90	1 1/4" Male Thread x 1 1/4" HB 90°
BJO HB125/100-90	1 1/4" Male Thread x 1" HB 90°
BJO HB125/150-90	1 1/4" Male Thread x 1 1/2" HB 90°
BJO HB150-90	1 1/2" Male Thread x 1 1/2" HB 90°
BJO HB200/150-90	2" Male Thread x 1 1/2" HB 90°
BJO HB200-90	2" Male Thread x 2" HB 90°

## POLY BOLTED "BOTTOM DRAIN" TANK FLANGES

Part #	Description
BJO BF100BD	1" x 1" Threaded Flange EPDM
BJO BF125BD	1 1/4" x 1" Threaded Flange EPDM
BJO BF150BD	1 1/2" x 2" Threaded Std. Port Flange EPDM



**THERE'S JUST NO SUBSTITUTE FOR SNYDER TANKS.**

Some of our more popular stock items - Contact us for a complete catalog of all SYNDER products

**PCO TANKS**

PART #	GALLONS	OUTLET SPECS	DIAMETER	HEIGHT	LENGTH
TAN 109137	30 gallon	U	19"	22-1/2"	24-1/2"
TAN 117137	50 gallon	U	19"	22-1/2"	38"
TAN 120137	100 gallon	U	30"	31"	38"
TAN 157137	150 gallon	U	36"	29"	48"
TAN 166137	200 gallon	U	36"	39-1/2"	48-1/2"
TAN 172137	300 gallon	U	38"	36-3/4"	69"



- Molded-in gallonage markers (indicators)
- Flat spots on each for easy agitation
- Design requires no additional support or banding
- UV inhibitors are molded in for longer tank life



**LEG TANKS**

PART #	GALLONS	OUTLET SPECS	DIAMETER	HEIGHT	LENGTH
TAN 10837	30 gallon	G	23"	25-3/4"	19-1/2"
TAN 10637	60 gallon	A	23"	25-3/4"	38"
TAN 11237	125 gallon	S	30"	34-1/2"	50"
TAN 12237	200 gallon	S	41"	31-3/4"	54"
TAN 12837	230 gallon	S	38"	42-1/2"	52"
TAN 13237	300 gallon	S	38"	42-1/2"	72"
TAN 14037	525 gallon	E	48"	52-1/2"	75"
TAN 13637	730 gallon	E	57-1/2"	57-1/2"	80"

- Molded-in gallonage markers (indicators)
- Free standing HLT requires no cradles for support
- Ribbed for strength with built-in supports
- UV inhibitors are molded in for longer tank life



**VERTICAL TANKS**

PART #	GALLONS	OUTLET SPECS	DIAMETER	HEIGHT
TAN 18237	550 gallon	N1	64"	46"
TAN 18037	550 gallon	N1	48"	74"
TAN 18337	1100 gallon	N2	64"	90"
TAN 17137	1100 gallon	I	86"	56"
TAN 17737	1500 gallon	I	86"	73"
TAN 741018	3000 gallon	N2	102"	97"

- Heavy duty bolted fittings standard on 550 gallon and above to reduce threat of fitting loosening during use
- Fitting compatible siphon tubes to allow bottom to fill of tank
- Molded-in tie downs for securing and lift lugs for easy movement
- UV inhibitors molded in for longer tank life

**OUTLETS**

A=6" fill, one 3/4" outlet with anti-vortex  
 C=10" fill, two 1-1/4" outlet (1 with anti-vortex)  
 U=No holes or fittings, Fittings can be ordered separately  
 E=10" fill, one 2" HD outlet with siphon  
 N2=18" manway, one 2" bolted outlet with siphon  
 N1=18" manway, one 2" HD outlet with siphon  
 G= 6" cap, no outlet  
 S= 10" fill, one 1 1/4" outlet  
 I= 10" fill, one 2" bolted outlet with syphon tube

**HORIZONTAL TANKS**

PART #	GALLONS	OUTLET SPECS	DIAMETER	HEIGHT	LENGTH
TAN 10337	25 gallon	A	23"	26-3/4"	19"
TAN 10537	55 gallon	A	23"	38-1/4"	38"
TAN 11137	110 gallon	C	30"	49-3/4"	50"
TAN 11337	150 gallon	C	30"	34-3/4"	60"
TAN 11537	150 gallon	C	32"	36-1/2"	56"
TAN 12337	200 gallon	C	32"	36-1/2"	71"
TAN 12537	200 gallon	C	38"	40-1/2"	52"



- 10" threaded cap for easy filling
- Molded-in gallonage markers (indicators)
- Center sumps and end flat spots
- UV inhibitors molded in for longer tank life
- Cradles required for support

<p><b>Snyder Standard Bulkhead Fittings (With EPDM gaskets)</b></p> <p>SNY 340001 3/4"                  SNY 340002 1"                  SNY 340003 1 1/4"                  SNY 340004 1 1/2"</p>	<p><b>IBC Tank Access Adapter</b></p> <p>2" Buttress x 2" Male                  NPT threads with                  Santoprene gasket                  BJO TA283</p>
---	--

SNYDER TANKS

# Spray Hose

Call OESCO, Inc. for all of your hose needs. We stock these hoses along with lay-flat discharge and custom hydraulic hoses



## LOW PRESSURE RUBBER SPRAY HOSE

MCG 1/4X2-67BH - 1/4" ID - 300 PSI rated  
 MCG 3/8X2-67BH - 3/8" ID - 300 PSI rated  
 MCG 1/2X2-67BH - 1/2" ID - 300 PSI rated  
 MCG 5/8X2-67BH - 5/8" ID - 200 PSI rated  
 MCG 3/4X2-67BH - 3/4" ID - 200 PSI rated  
 MCG 1X2-67BH - 1" ID - 200 PSI rated  
 MCG 1-1/4X2-67BH - 1 1/4" ID - 150 PSI rated  
 MCG 1-1/2X2-67BH - 1 1/2" ID - 250 PSI rated



## HIGH PRESSURE RUBBER SPRAY HOSE

750 PSI rated

MCG 006-NR-SPRAY - 3/8" ID Spray Hose  
 MCG 008-NR-SPRAY - 1/2" ID Spray Hose  
 MCG 012-NR-SPRAY - 3/4" ID Spray Hose  
 MCG 016-NR-SPRAY - 1" ID Spray Hose



## NYLON BRAIDED HOSE

Nylon braided hose, 250 lbs. maximum pressure sizes available, food & beverage rated.

FLO 2H5015-0375 - 3/8" ID - 225 PSI  
 FLO 2H5015-050 - 1/2" ID - 200 PSI  
 FLO 2H5015-0625 - 5/8" ID - 200 PSI  
 FLO 2H5015-075 - 3/4" ID - 150 PSI  
 FLO 2H5015-100 - 1" ID - 125 PSI  
 FLO 2H5015-125 - 1 1/4" ID - 100 PSI



## CLEAR PVC TUBING, FDA COMPLIANT

MCG ABH02017 - 1/4" ID 1/16" wall thickness  
 MCG ABH02027 - 3/8" ID 1/16" wall thickness  
 MCG ABH02036 - 1/2" ID 1/16" wall thickness  
 MCG ABH02046 - 5/8" ID 1/8" wall thickness  
 MCG ABH02053 - 3/4" ID 1/8" wall thickness  
 MCG ABH00062 - 1" ID 1/8" wall thickness  
 MCG ABH00071 - 1-1/4" ID 1/4" wall thickness



## GOODYEAR 600 PSI BRAID-REINFORCED PVC SPRAY HOSE

MCG 006Pliovic1800 - 3/8" ID - 600 PSI PVC hose  
 MCG 008Pliovic1800 - 1/2" ID - 600 PSI PVC hose  
 MCG 012Pliovic1800 - 3/4" ID - 600 PSI PVC hose



## SUCTION HOSE

We supply vinyl and all weather suction hose for suction use which can also be used for low pressure transfer hose. Other suction hose available - call for details.

MCG 016-300-EPDM - 1" ID - all weather rubber  
 MCG 020-300-EPDM - 1 1/4" ID - all weather rubber  
 MCG 024-300-EPDM - 1 1/2" ID - all weather rubber  
 MCG 032-300-EPDM - 2" ID - all weather rubber  
 MCG 040-300-EPDM - 2 1/2" ID - all weather rubber  
 MCG 048-300-EPDM - 3" ID - all weather rubber



## CLEAR SUCTION HOSE

REA HNP075 - 3/4" Armovin wire reinforced PVC  
 REA HNP100 - 1" Armovin wire reinforced PVC  
 REA HNP125 - 1 1/4" Armovin wire reinforced PVC  
 REA HNP150 - 1 1/2" Armovin wire reinforced PVC  
 REA HNP200 - 2" Armovin wire reinforced PVC



## REINFORCED CLEAR PVC TUBING, FDA COMPLIANT

FLO 2XWT100-100 - 1" diameter  
 FLO 2XWT125-100 - 1 1/4" diameter  
 FLO 2XWT150-100 - 1 1/2" diameter  
 FLO 2XWT200-100 - 2" diameter

Spray hose is sized by ID (inside diameter)

Hose can be cut to any length

Fittings and Coupling sets installed to order

We stock thousands of feet of hose!

HOSE

## GILMORE FLEXOGEN GARDEN HOSE

8 ply construction assures durability in all weather. Double tire cord reinforced for strength. Lightweight and flexible. 500 PSI burst rated.

### Sizes available:

GIL 10-12025 - 1/2" ID x 25' long - GHT couplings • 3 lbs./roll  
 GIL 10-12050 - 1/2" ID x 50' long - GHT couplings • 5 lbs./roll  
 GIL 10-58050 - 5/8" ID x 50' long - GHT couplings • 8 lbs./roll  
 GIL 10-58075 - 5/8" ID x 75' long - GHT couplings • 12 lbs./roll  
 GIL 10-58100 - 5/8" ID x 100' long - GHT couplings • 16 lbs./roll  
 GIL 10-34025 - 3/4" ID x 25' long - uncoupled • 5 lbs./roll

### The last hose you'll ever buy!!!

Flexogen is the hose that has long set the standard for quality in garden hoses. Recognized by consumers and trade alike, it offers the ultimate in quality and value.

GIL 10-34250 - 3/4" ID x 250' long - uncoupled • 52 lbs./roll  
 GIL 10-34050 - 3/4" ID x 50' long - GHT couplings • 8 lbs./roll  
 GIL 10-34075 - 3/4" ID x 75' long - GHT couplings • 12 lbs./roll  
 GIL 10-34100 - 3/4" ID x 100' long - GHT couplings • 21 lbs./roll  
 GIL 10-10075 - 1" ID x 75' long - coupled 1" NPT • 32 lbs./roll  
 GIL 10-10100 - 1" ID x 100' long - coupled 1" NPT • 40 lbs./roll





## PVC High Pressure Spray Hose

### 3 Year Warranty

So good we warrantee it for 3 years! Reinforced PVC with high burst strength. Melded inner core and cover to form complex reinforcement that will not separate under high pressure. Light, bright colors are easy to see, won't mark curbs or sidewalks. Sizes to fit any need. Costs you less because it lasts longer.

## BRAID-REINFORCED PROFESSIONAL PVC HOSE

### OUR BEST SPRAY HOSE!

Order by the foot or by the roll.



### Inner reinforced PVC Hose for high strength



Dark Gray Spiral

Light Gray PVC

Neon PVC

### Couplings installed on hose to order.

Please specify installation requirements when ordering. See pages 101 & 102 for couplings.

*Note: Other Green Garde hose available by special order only.*

*Example: twin hose, clear spiral PVC hose, etc.*



### High-Pressure, Braid-Reinforced, Neon, PVC Hose 800 PSI working pressure, 3000 PSI burst

GRE 38684 - 3/8" x 300'  
GRE 38685 - 3/8" x 400'  
GRE 38686 - 3/8" x 600'  
GRE 38688 - 1/2" x 300'  
GRE 38689 - 1/2" x 400'

GRE 38690 - 1/2" x 600'  
GRE 38553 - 5/8" x 300'  
GRE 38692 - 5/8" x 400'  
GRE 38695 - 3/4" x 300'  
GRE 38696 - 3/4" x 400'

### High-Pressure, Spiral-Reinforced, Light Gray, PVC Hose 600 PSI working pressure, 2400 PSI burst

GRE 38710 - 3/8" x 300'  
GRE 38712 - 3/8" x 400'

GRE 38715 - 1/2" x 300'  
GRE 38717 - 1/2" x 400'

### Dark Gray Spiral Hose

300 PSI working pressure, 1200 PSI burst

GRE 38725 - 3/8" x 300'  
GRE 38726 - 3/8" x 400'

GRE 38727 - 1/2" x 300'  
GRE 38728 - 1/2" x 400'

### HOSE CUTTER

Here's a fast and clean tool to cut hose. No deburring necessary and it's light-weight with strong nylon handles. Replacement blades available.

GRE 38930 - Hose Cutter • 8 oz.

GRE 38931 - Replacement Blade • 1 oz.



GREEN GARDE SPRAY HOSE

# Hypro® Stainless Steel Fittings

All 304 Stainless Steel



## MALE PIPE THREAD BY HOSE BARB - MPT x HB

- HYP 9A14 - 1/4" x 1/4"
- HYP 9A12 - 1/2" x 1/2"
- HYP 9A34 - 3/4" x 3/4"
- HYP 9A100 - 1" x 1"



## STREET ELBOW: FEMALE PIPE THREAD BY MALE PIPE THREAD - MPT x FPT

- HYP 7SE14 - 1/4" x 1/4"
- HYP 7SE12 - 1/2" x 1/2"
- HYP 7SE34 - 3/4" x 3/4"
- HYP 7SE100 - 1" x 1"



## COUPLING: FEMALE PIPE THREAD - FPT x FPT

- HYP 7FC14 - 1/4" x 1/4"
- HYP 7FC12 - 1/2" x 1/2"
- HYP 7FC34 - 3/4" x 3/4"
- HYP 7FC100 - 1" x 1"



## TEE: FEMALE PIPE THREAD

- HYP 7TT14 - 1/4" x 1/4" x 1/4"
- HYP 7TT12 - 1/2" x 1/2" x 1/2"
- HYP 7TT34 - 3/4" x 3/4" x 3/4"
- HYP 7TT100 - 1" x 1" x 1"



## ELBOW: FEMALE PIPE THREAD 90° - FPT x FPT

- HYP 7LL14 - 1/4" x 1/4"
- HYP 7LL12 - 1/2" x 1/2"
- HYP 7LL34 - 3/4" x 3/4"
- HYP 7LL100 - 1" x 1"



## REDUCER BUSHING - MPT x FPT

- HYP 7RB3814 - 3/8" x 1/4"
- HYP 7RB1214 - 1/2" x 1/4"
- HYP 7RB1238 - 1/2" x 3/8"
- HYP 7RB3412 - 3/4" x 1/2"
- HYP 7RB10034 - 1" x 3/4"



## NIPPLE - MPT x LENGTH

- HYP 714112 - 1/4" x 1 1/2"
- HYP 714300 - 1/4" x 3"
- HYP 712118 - 1/2" x 1 1/8"
- HYP 712112 - 1/2" x 1 1/2"
- HYP 712200 - 1/2" x 2"
- HYP 734138 - 3/4" x 1 3/8"
- HYP 734400 - 3/4" x 4"
- HYP 7100112 - 1" x 1 1/2"
- HYP 7100400 - 1" x 4"

## TUFF-LITE NYLON INSERTS & SHORT SHANK COUPLINGS



### Female

- 1/2" Hose Size  
DVC TCF74 - 3/4" GHT • 1 oz.
- 3/4" Hose Size  
DVC TCF76 - 3/4" GHT • 1 oz.



### Male

- 1/2" Hose Size  
DVC TCM74 - 3/4" GHT • 1 oz.
- 3/4" Hose Size  
DVC TCM76 - 3/4" GHT • 1 oz.



## Fittings

### Nylon Hose Fittings



#### 1/4" Hose Size

- DVC TN21 - 1/8" MPT • 1 oz.
- DVC TN22 - 1/4" MPT • 1 oz.
- DVC TN23 - 3/8" MPT • 1 oz.
- DVC TN24 - 1/2" MPT • 1 oz.
- DVC TN26 - 3/4" MPT • 1 oz.
- DVC TN28 - 1" MPT • 1 oz.

#### 5/16" Hose Size

- DVC TN252 - 1/4" MPT • 1 oz.

#### 3/8" Hose Size

- DVC TN31 - 1/8" MPT • 1 oz.
- DVC TN32 - 1/4" MPT • 1 oz.
- DVC TN33 - 3/8" MPT • 1 oz.
- DVC TN34 - 1/2" MPT • 1 oz.
- DVC TN36 - 3/4" MPT • 1 oz.

#### 1/2" Hose Size

- DVC TN41 - 1/8" MPT • 1 oz.
- DVC TN42 - 1/4" MPT • 1 oz.
- DVC TN43 - 3/8" MPT • 1 oz.
- DVC TN44 - 1/2" MPT • 1 oz.
- DVC TN46 - 3/4" MPT • 1 oz.

#### 5/8" Hose Size

- DVC TN53 - 3/8" MPT • 2 oz.
- DVC TN54 - 1/2" MPT • 2 oz.
- DVC TN56 - 3/4" MPT • 2 oz.

#### 3/4" Hose Size

- DVC TN63 - 3/8" MPT • 2 oz.
- DVC TN64 - 1/2" MPT • 2 oz.
- DVC TN66 - 3/4" MPT • 2 oz.
- DVC TN68 - 1" MPT • 2 oz.

#### 1" Hose Size

- DVC TN86 - 3/4" MPT • 3 oz.
- DVC TN88 - 1" MPT • 3 oz.

#### 1 1/4" Hose Size

- DVC TN158 - 1" MPT • 3 oz.
- DVC TN150 - 1 1/4" MPT • 3 oz.
- DVC TN1520 - 1 1/2" MPT • 3 oz.

#### 1 1/2" Hose Size

- DVC TN2015 - 1 1/4" MPT • 3 oz.
- DVC TN200 - 1 1/2" MPT • 3 oz.

#### 2" Hose Size

- DVC TN250 - 2" MPT • 4 oz.

Order  
Online

### NYLON TEES

- DVC TSST222 - 1/4" x 1/4" x 1/4" MPT
- DVC TSST333 - 3/8" x 3/8" x 3/8" MPT
- DVC TSST444 - 1/2" x 1/2" x 1/2" MPT
- DVC TSST666 - 3/4" x 3/4" x 3/4" MPT

### NYLON TEES

- DVC TSSS222 - 1/4" x 1/4" x 1/4"
- DVC TSSS333 - 3/8" x 3/8" x 3/8"
- DVC TSSS444 - 1/2" x 1/2" x 1/2"
- DVC TSSS666 - 3/4" x 3/4" x 3/4"

### TUFF LITE 90° NYLON ELL

- DVC TLSS22 - 1/4" Hose size
- DVC TLSS33 - 3/8" Hose size
- DVC TLSS44 - 1/2" Hose size
- DVC TLSS66 - 3/4" Hose size

### TUFF LITE 90° NYLON

#### THREADED ELL

- DVC TLS21 - 1/8" MPT, 1/4" Hose
- DVC TLS22 - 1/4" MPT, 1/4" Hose
- DVC TLS23 - 3/8" MPT, 1/4" Hose

- DVC TLS31 - 1/8" MPT, 3/8" Hose
- DVC TLS32 - 1/4" MPT, 3/8" Hose
- DVC TLS33 - 3/8" MPT, 3/8" Hose
- DVC TLS34 - 1/2" MPT, 3/8" Hose
- DVC TLS36 - 3/4" MPT, 3/8" Hose

- DVC TLS42 - 1/4" MPT, 1/2" Hose
- DVC TLS43 - 3/8" MPT, 1/2" Hose
- DVC TLS44 - 1/2" MPT, 1/2" Hose
- DVC TLS46 - 3/4" MPT, 1/2" Hose
- DVC TLS48 - 1" MPT, 1/2" Hose

- DVC TLS53 - 3/8" MPT, 5/8" Hose
- DVC TLS54 - 1/2" MPT, 5/8" Hose
- DVC TLS56 - 3/4" MPT, 5/8" Hose
- DVC TLS58 - 1" MPT, 5/8" Hose

- DVC TLS63 - 3/8" MPT, 3/4" Hose
- DVC TLS64 - 1/2" MPT, 3/4" Hose
- DVC TLS66 - 3/4" MPT, 3/4" Hose
- DVC TLS68 - 1" MPT, 3/4" Hose

- DVC TLS86 - 3/4" Male NPT, 1" Hose
- DVC TLS88 - 1" Male NPT, 1" Hose

### TUFF-LITE MENDER - (HIGH TENSILE NYLON)

- DVC TM2 - 1/4" • 1 oz.
- DVC TM25 - 5/16" • 1 oz.
- DVC TM3 - 3/8" • 1 oz.
- DVC TM4 - 1/2" • 1 oz.
- DVC TM5 - 5/8" • 2 oz.
- DVC TM6 - 3/4" • 2 oz.
- DVC TM8 - 1" • 2 oz.



### DIXON BRASS HOSE MENDER

- DVC BM15 - 3/16" • 1 oz.
- DVC BM2 - 1/4" • 1 oz.
- DVC BM25 - 5/16" • 1 oz.
- DVC BM3 - 3/8" • 1 oz.
- DVC BM4 - 1/2" • 1 oz.
- DVC BM6 - 3/4" • 1 oz.



### "Boss" HOSE MENDER

Collars to engage grip fingers of "Boss" clamps. Plated materials malleable iron or plated tubular steel depending on size.

- DVC KM42 - 1/2" • .25 lb.
- DVC KM52 - 5/8" • .25 lb.
- DVC KM62 - 3/4" • .50 lb.
- DVC KM82 - 1" • .75 lb.

Other sizes available by special order



STAINLESS STEEL/NYLON FITTINGS

We stock thousands of fittings. Call us with your needs.



**CLOSE NIPPLE:**

PART #	PIPE
FAI 112-A	1/8
FAI 112-B	1/4
FAI 112-C	3/8
FAI 112-D	1/2
FAI 112-E	3/4
FAI 112-H	1



**HEX NIPPLE:**

PART #	PIPE
FAI 122-A	1/8
FAI 122-B	1/4
FAI 122-C	3/8
FAI 122-D	1/2



**REDUCING HEX NIPPLE:**

PART #	PIPE	PIPE
FAI 122-BA	1/4 to 1/8	
FAI 122-CA	3/8 to 1/8	
FAI 122-CB	3/8 to 1/4	
FAI 122-DB	1/2 to 1/4	
FAI 122-DC	1/2 to 3/8	

**LONG NIPPLE:**

PART #	PIPE	LENGTH
1/4 NPT		
FAI 113-B1-1/2	1/4	1 1/2"
FAI 113-B2	1/4	2"
FAI 113-B3	1/4	3"
3/8 NPT		
FAI 113-C1-1/2	3/8	1 1/2"
FAI 113-C2	3/8	2"
FAI 113-C3	3/8	3"
1/2 NPT		
FAI 113-D1-1/2	1/2	1 1/2"
FAI 113-D2	1/2	2"
FAI 113-D3	1/2	3"



**REDUCING COUPLING:**

PART #	PIPE	PIPE
FAI 119-BA	1/4 to 1/8	
FAI 119-CA	3/8 to 1/8	
FAI 119-CB	3/8 to 1/4	
FAI 119-DA	1/2 to 1/8	
FAI 119-DB	1/2 to 1/4	
FAI 119-DC	1/2 to 3/8	



**BUSHING**

PART #	MALE PIPE	FEMALE PIPE
FAI 110-BA	1/4 to 1/8	
FAI 110-CA	3/8 to 1/8	
FAI 110-CB	3/8 to 1/4	
FAI 110-DA	1/2 to 1/8	
FAI 110-DB	1/2 to 1/4	
FAI 110-DC	1/2 to 3/8	
FAI 110-EB	3/4 to 1/4	
FAI 110-ED	3/4 to 1/2	
FAI 110-HE	1 to 3/4	



**SQUARE PLUG:**

PART #	PIPE
FAI 109-A	1/8
FAI 109-B	1/4
FAI 109-C	3/8
FAI 109-D	1/2
FAI 109-E	3/4



**CAP:**

PART #	PIPE
FAI 108-A	1/8
FAI 108-B	1/4
FAI 108-C	3/8
FAI 108-D	1/2
FAI 108-E	3/4



**FORGED 90° ELBOW:**

PART #	PIPE
FAI 99-B	1/4



**FORGED 90° STREET ELBOW:**

PART #	PIPE
FAI 116-A	1/8
FAI 116-B	1/4
FAI 116-C	3/8



**90° STREET ELBOW (CAST BRONZE):**

PART #	PIPE
FAI 116CA-D	1/2
FAI 116CA-E	3/4

**FORGED 90° ELBOW:**

PART #	PIPE
FAI 100-A	1/8
FAI 100-B	1/4
FAI 100-C	3/8



**90° ELBOW (CAST BRONZE):**

PART #	PIPE
FAI 100CA-D	1/2
FAI 100CA-E	3/4

**EXTRUDED 45° STREET ELBOW:**

PART #	PIPE
FAI X124-A	1/8
FAI X124-B	1/4
FAI X124-C	3/8



**45° STREET ELBOW (CAST BRONZE):**

PART #	PIPE
FAI 124-D	1/2
FAI 124-E	3/4

**EXTRUDED 45° ELBOW:**

PART #	PIPE
FAI X105-A	1/4



**EXTRUDED CROSS:**

PART #	PIPE
FAI X102-B	1/4



**FORGED MALE BRANCH TEE:**

PART #	PIPE
FAI X106-B	1/4



**FORGED STREET TEE:**

PART #	PIPE
FAI 107-B	1/4



**FORGED TEE:**

PART #	PIPE
FAI 101-A	1/8
FAI 101-B	1/4
FAI 101-C	3/8



**TEE (CAST BRONZE):**

PART #	PIPE
FAI 101CA-D	1/2
FAI 101CA-E	3/4



**BRASS ADAPTER MALE GHT x FEMALE NPT:**

DVC BA794 - MHT x 1/2" FPT
DVC BA796 - MHT x 3/4" MPT
DVC FM1076 - MHT x 1" FPT
Weight: 2 oz. each



**BRASS ADAPTER FEMALE GHT x MALE NPT:**

DVC BMA974 - FHT x 1/2" MPT
DVC BMA976 - FHT x 3/4" MPT
DVC IM7610T - FHT x 1" MPT
Weight: 2 oz. each



**BRASS ADAPTER MALE GHT x MALE NPT:**

DVC BA73 - MHT x 3/8" MPT
DVC BA74 - MHT x 1/2" MPT
DVC BA776 - MHT x 3/4" MPT
Weight: 2 oz. each



**BRASS GHT x GHT ADAPTERS:**

Male: DVC BA777 - MHT x MHT
Female: DVC BA977 - not pictured
FHT x FHT
Weight: 2 oz. each



**BRASS ADAPTER FEMALE GHT x FEMALE NPT:**

DVC BA974 - FHT x 1/2" FPT
DVC BA976 - FHT x 3/4" FPT
Weight: 2 oz. each



**"KING" SHORT SHANK SUCTION COUPLINGS (NPSM THREAD)**

**Female: All Brass Including Swivel Nut**

DVC BS848 - 1" • .50 lb.
DVC FBB150 - 1 1/2" • .75 lb.
DVC FBB200 - 2" • 1 lb.
DVC FBB250 - 2 1/2" • 2 lbs.
DVC FBB300 - 3" • 3 lbs.
DVC FBB400 - 4" • 4 lbs.



**Male - All Brass**

DVC BS818 - 1" • .50 lb.
DVC MB125 - 1 1/4" • .50 lb.
DVC MB150 - 1 1/2" • .75 lb.
DVC MB200 - 2" • 1 lb.
DVC MB250 - 2 1/2" • 2 lbs.
DVC MB300 - 3" • 3 lbs.
DVC MB400 - 4" • 4 lbs.



BRASS FITTINGS

## Plated Steel Coupling Sets and Hose Fittings for Spray Hose

Coupling sets are important factors in prolonging the life of your high pressure hose. We supply Green Garde hose fittings on all high pressure hose we sell. These hose fittings are designed to assure maximum flow with large ID and long shanks. The shank end is rounded to prevent early hose failure and to aid in the installation of fittings on the hose.

All below threads are GHT

GREEN GARDE HIGH PRESSURE HOSE FITTINGS			Shank Length inches
No.	Description	Fits Hose ID inches	
GRE 38941	1/2" barb shank X MHT	1/2"	2 5/16"
GRE 38940	1/2" barb shank (w/nut and washer) X FHT	1/2"	2 5/16"
GRE 38944	5/8" barb shank X MHT	5/8"	2 3/8"
GRE 38943	5/8" barb (w/nut & washer) X FHT	5/8"	2 3/8"
GRE 38947	3/4" barb X MHT	3/4"	2 5/16"
GRE 38946	3/4" barb (w/nut & washer) X FHT	3/4"	2 5/16"

<b>DIXON HIGH PRESSURE 3/8" HOSE FITTINGS</b>	<b>DVC SLS347</b>	3/8" hose barb x 3/4" FHT
	<b>DVC SLS317</b>	3/8" hose barb x 3/4" MHT



Complete Green Garde coupling sets. Order by individual part.

### Fittings, Coupling Sets and Adapters

Note: All fittings are identified by listing the thread as (m) male, (f) female, (pt) pipe thread. (GHT) Hose thread means 3/4" garden hose thread, (m) male, (f) female. Hose barbs (HB) or hose shanks are the size of the ID of the hose the barb is fitting into.

## BRASS HOSE BARBS



BN	Hose shank X Male Pipe Thread	Sh.Wt.
DVC BN11	1/8" x 1/8" MPT	1 oz.
DVC BN151	3/16" x 1/8" MPT	1 oz.
DVC BN152	3/16" x 1/4" MPT	1 oz.
DVC BN21	1/4" x 1/8" MPT	1 oz.
DVC BN22	1/4" x 3/8" MPT	1 oz.
DVC BN23	1/4" x 3/8" MPT	2 oz.
DVC BN251	5/16" x 1/8" MPT	1 oz.
DVC BN252	5/16" x 1/4" MPT	1 oz.
DVC BN253	5/16" x 3/8" MPT	2 oz.
DVC BN31	3/8" x 1/8" MPT	1 oz.
DVC BN32	3/8" x 1/4" MPT	1 oz.
DVC BN33	3/8" x 3/8" MPT	1 oz.
DVC BN34	3/8" x 1/2" MPT	2 oz.
DVC BN42	1/2" x 1/4" MPT	1 oz.
DVC BN43	1/2" x 3/8" MPT	2 oz.
DVC BN44	1/2" x 1/2" MPT	2 oz.
DVC BN46	1/2" x 3/4" MPT	3 oz.
DVC BN53	5/8" x 3/8" MPT	2 oz.
DVC BN54	5/8" x 1/2" MPT	2 oz.
DVC BN56	5/8" x 3/4" MPT	3 oz.
DVC BN64	3/4" x 1/2" MPT	2 oz.
DVC BN66	3/4" x 3/4" MPT	3 oz.
DVC BN86	1" x 3/4" MPT	3 oz.
DVC BN88	1" x 1" MPT	3 oz.

## HOSE SHANK TYPE FITTING PLATED STEEL



Hose shank X Male Pipe Thread	Weight
DVC STC1	1/2" x 1/2" MPT • 1/4 lb.
DVC STC5	3/4" x 3/4" MPT • 1/4 lb.
DVC STC10	1" x 1" MPT • 1/4 lb.
DVC STC15	1 1/4" x 1 1/4" MPT • 1/2 lb.
DVC STC20	1 1/2" x 1 1/2" MPT • 1/2 lb.
DVC STC25	2" x 2" MPT • 1 lb.
DVC STC30	2 1/2" x 2 1/2" MPT • 2 lbs.
DVC STC35	3" x 3" MPT • 3 lbs.

## BRASS SHORT SHANK FITTINGS GHT THREAD X HOSE SHANK



Female with Swivel:  
 DVC BCF73 - FHT x 3/8" • 2 oz.  
 DVC BCF74 - FHT x 1/2" • 2 oz.  
 DVC BCF75 - FHT x 5/8" • 2 oz.  
 DVC BCF76 - FHT x 3/4" • 2 oz.  
 Male:  
 DVC BCM73 - MHT x 3/8" • 2 oz.  
 DVC BCM74 - MHT x 1/2" • 2 oz.  
 DVC BCM75 - MHT x 5/8" • 2 oz.  
 DVC BCM76 - MHT x 3/4" • 2 oz.

## STAINLESS STEEL SHORT SHANK COUPLINGS



Hose shank X Male Pipe Thread	Weight
DVC RST1	1/2" x 1/2" MPT • 1/4 lb.
DVC RST5	3/4" x 3/4" MPT • 1/4 lb.
DVC RST10	1" x 1" MPT • 1/4 lb.
DVC RST15	1 1/4" x 1 1/4" MPT • 1/2 lb.
DVC RST20	1 1/2" x 1 1/2" MPT • 1/2 lb.
DVC RST25	2" x 2" MPT • 1 lb.

## WINGNUT FITTINGS



Elbow fitting -  
**REA EL050F037HB**  
 90° 3/8" Barb X 1/2" FPT Wingnut  
**REA EL050F050HB**  
 90° 1/2" Barb X 1/2" FPT Wingnut

Straight fitting -  
**HYP 9910-110130**  
 1/2" Barb X 1/2" FPT Wingnut  
**HYP 9910-110131**  
 3/8" Barb X 1/2" FPT Wingnut

## "KING" STEEL NIPPLES



DVC KHN222	- 1/4" x 1/4" MPT • 1 oz.
DVC KHN322	- 3/8" x 1/4" MPT • 1 oz.
DVC KHN332	- 3/8" x 3/8" MPT • 2 oz.
DVC KHN342	- 3/8" x 1/2" MPT • 4 oz.
DVC KHN422	- 1/2" x 1/4" MPT • 1 oz.
DVC KHN432	- 1/2" x 3/8" MPT • 4 oz.
DVC KHN442	- 1/2" x 1/2" MPT • 4 oz.
DVC KHN462	- 1/2" x 3/4" MPT • 6 oz.
DVC KHN642	- 3/4" x 1/2" MPT • 2 oz.
DVC KHN662	- 3/4" x 3/4" MPT • 6 oz.
DVC KHN862	- 1" x 3/4" MPT • 6 oz.
DVC KHN882	- 1" x 1" MPT • 10 oz.

## Washers for Suction, Long and Short Shank Couplings

<b>Rubber Washer:</b>	<b>Leather Washer:</b>
DVC KRW5 - 3/4"	DVC KLW5 - 3/4"
DVC KRW10 - 1"	DVC KLW10 - 1"
DVC KRW15 - 1 1/4"	
DVC KRW20 - 1 1/2"	
DVC KRW25 - 2"	
DVC KRW30 - 2 1/2"	
DVC KRW35 - 3"	

• Shipping wt. 1 oz. each  
**Special Note:**  
 Use DVC KLW5 washers for standard 3/4" coupling sets.





### GHT Quick Couplers

**DVC DGH7P**  
Male Plug X Male GHT



**DVC DGH7C**  
Female Coupler  
X Female GHT



**Fairview Brass**  
GHT "Y" Coupler  
FAI 202W

**GHT 4-Valve**  
Manifold Nozzle  
DVC 500-GH4V



### INSULATED WATER NOZZLE

Heavy duty brass valve and adjusting nut. Hold open clip locks any spray pattern. Chrome plated all zinc body. Industrial strength nylon handle. Rubber head guard on threaded GHT front version. Hot water up to 180°F.

**DVC SN75**

### CAMPBELL BRASS FOOT VALVES



Abrasion resistant. Certified red brass castings, stainless steel springs, non-corrosive nylon stem guide and stainless steel screen. For pump suction hoses.

**GRA 5YM42** - 3/4" Female pipe thread  
**GRA 5YM43** - 1" Female pipe thread  
**GRA 5YM44** - 1 1/4" Female pipe thread  
**GRA 5YM45** - 1 1/2" Female pipe thread  
**GRA 5YM46** - 2" Female pipe thread



### SUCTION HOSE STRAINERS

Nickel plated, standard threaded type.  
**DVC RHS20** - 1 1/2" FPT • 1 1/2 lbs.  
**DVC RHS25** - 2" FPT • 2 lbs.  
**DVC RHS30** - 2 1/2" FPT • 2 1/2 lbs.

Other strainer styles and sizes available by special order



We believe this is the best and least expensive product in its field. The many advantages include cost saving, lightweight, easy working cams and fast connecting.

### NY-GLASS

- Yellow Corrosion Resistant
- Will not go "out of round" when dropped.
- Will not easily cross thread as other plastic couplings do.
- Weight is 1/6 that of brass and 1/2 that of aluminum.

Use N suffix for NY-Glass.



- White Food Grade couplings
  - Lightweight
  - Easy to install
  - Many styles available
- Use F suffix for Food-Flo.

### QUICK COUPLINGS

#### BRASS STRAIGHT THROUGH QUICK-CONNECT FITTINGS

##### MALE NPT COUPLERS



**DVC STMC2** - 1/4", 4500 PSI  
**DVC STMC3** - 3/8", 2700 PSI  
**DVC STMC4** - 1/2", 2500 PSI  
**DVC STMC6** - 3/4", 2000 PSI

##### FEMALE NPT COUPLERS



**DVC STFC2** - 1/4", 4500 PSI  
**DVC STFC3** - 3/8", 2700 PSI  
**DVC STFC4** - 1/2", 2500 PSI  
**DVC STFC6** - 3/4", 2000 PSI

##### MALE NPT ADAPTERS



**DVC STMP2B** - 1/4", 4500 PSI  
**DVC STMP3B** - 3/8", 2700 PSI  
**DVC STMP4B** - 1/2", 2200 PSI  
**DVC STMP6B** - 3/4", 1700 PSI

##### FEMALE NPT ADAPTERS



**DVC STFP2B** - 1/4", 4500 PSI  
**DVC STFP3B** - 3/8", 2700 PSI  
**DVC STFP4B** - 1/2", 2200 PSI  
**DVC STFP6B** - 3/4", 1700 PSI

### NY GLASS COMPONENTS PICTURED

Size	NY-Glass	Food-Flo
<b>Type A</b>	<b>Male Adapter X Female N.P.T.</b>	
1/4"	FLO-025-A-N	-
3/8"	FLO-037-A-N	-
1/2"	FLO-050-A-N	-
3/4"	FLO-075-A-N	FLO-075-A-F
1"	FLO-100-A-N	FLO-100-A-F
1 1/4"	FLO-125-A-N	-
1 1/2"	FLO-150-A-N	FLO-150-A-F
2"	FLO-200-A-N	FLO-200-A-F



Size	NY-Glass	Food-Flo
<b>Type B</b>	<b>Female Coupler X Male N.P.T.</b>	
1/2"	FLO-050-B-N	-
3/4"	FLO-075-B-N	FLO-075-B-F
1"	FLO-100-B-N	FLO-100-B-F
1 1/4"	FLO-125-B-N	-
1 1/2"	FLO-150-B-N	FLO-150-B-F
2"	FLO-200-B-N	FLO-200-B-F



Size	NY-Glass	Food-Flo
<b>Type C</b>	<b>Female Coupler X Hose Shank</b>	
1/2"	FLO-050-C-N	-
5/8"	FLO-062-C-N	-
3/4"	FLO-075-C-N	FLO-075-C-F
1"	FLO-100-C-N	FLO-100-C-F
1 1/4"	FLO-125-C-N	-
1 1/2"	FLO-150-C-N	FLO-150-C-F
2"	FLO-200-C-N	FLO-200-C-F



Size	NY-Glass	Food-Flo
<b>TYPE D</b>	<b>Female Coupler X Female N.P.T.</b>	
1/4"	FLO-025-D-N	-
3/8"	FLO-037-D-N	-
1/2"	FLO-050-D-N	-
3/4"	FLO-075-D-N	FLO-075-D-F
1"	FLO-100-D-N	FLO-100-D-F
1 1/4"	FLO-125-D-N	-
1 1/2"	FLO-150-D-N	FLO-150-D-F
2"	FLO-200-D-N	FLO-200-D-F



Size	NY-Glass	Food-Flo
<b>Type E</b>	<b>Male Adapter X Hose Shank</b>	
1/2"	FLO-050-E-N	-
5/8"	FLO-062-E-N	-
3/4"	FLO-075-E-N	FLO-075-E-F
1"	FLO-100-E-N	FLO-100-E-F
1 1/4"	FLO-125-E-N	-
1 1/2"	FLO-150-E-N	FLO-150-E-F
2"	FLO-200-E-N	FLO-200-E-F



Size	NY-Glass	Food-Flo
<b>Type F</b>	<b>Male Adapter X Male N.P.T.</b>	
1/2"	FLO-050-F-N	-
3/4"	FLO-075-F-N	FLO-075-F-F
1"	FLO-100-F-N	FLO-100-F-F
1 1/4"	FLO-125-F-N	-
1 1/2"	FLO-150-F-N	FLO-150-F-F
2"	FLO-200-F-N	FLO-200-F-F



Size	NY-Glass	Food-Flo
<b>Type DP</b>	<b>Dust Plug</b>	
3/4"	FLO-075-DP-N	FLO-075-DP-F
1"	FLO-100-DP-N	FLO-100-DP-F
1 1/2"	FLO-150-DP-N	FLO-150-DP-F
2"	FLO-200-DP-N	FLO-200-DP-F



Size	NY-Glass	Food-Flo
<b>Type DC</b>	<b>Dust Cap</b>	
3/4"	FLO-075-DC-N	FLO-075-DC-F
1"	FLO-100-DC-N	FLO-100-DC-F
1 1/2"	FLO-150-DC-N	FLO-150-DC-F
2"	FLO-200-DC-N	FLO-200-DC-F



Other larger sizes are available by special order.

CAMLOCKS/COUPLINGS

## HYDRAULIC COUPLINGS

### HYDRAULIC QUICK-CONNECT FITTINGS

The Agricultural Quick-Connect features ball style shut-off valves in both the coupler and the plug. Operating pressure up to 2500 PSI.

#### FPT Ball Valve Coupler



**PIO 4050-2P** – 1/4" NPTF Thread size, 1/4" Body size  
**PIO 4050-3P** – 3/8" NPTF Thread size, 3/8" Body size  
**PIO 4050-4PMB** – 1/2" NPTF Thread size, 1/2" Body size

#### FPT Ball Valve Plug



**PIO 4010-2P** – 1/4" NPTF Thread size, 1/4" Body size  
**PIO 4010-3P** – 3/8" NPTF Thread size, 3/8" Body size  
**PIO 8010-4PMB** – 1/2" NPTF Thread size, 1/2" Body size

### HYDRAULIC PIPE SWIVEL ADAPTERS

#### Straight Male Pipe by Female Pipe Swivel



**DVC 1404-2-2** – 1/8" T2 Female NPSM, 1/4" T1 Male NPTF  
**DVC 1404-4-4** – 1/4" T2 Female NPSM, 1/4" T1 Male NPTF  
**DVC 1404-6-6** – 3/8" T2 Female NPSM, 3/8" T1 Male NPTF  
**DVC 1404-8-8** – 1/2" T2 Female NPSM, 1/2" T1 Male NPTF  
**DVC 1404-12-12** – 3/4" T2 Female NPSM, 3/4" T1 Male NPTF  
**DVC 1404-16-16** – 1" T2 Female NPSM, 1" T1 Male NPTF

#### 90° Male Pipe by Female Pipe Swivel



**DVC 1501-2-2** – 1/8" T2 Female NPSM, 1/8" T1 Male NPTF  
**DVC 1501-4-4** – 1/4" T2 Female NPSM, 1/4" T1 Male NPTF  
**DVC 1501-6-6** – 3/8" T2 Female NPSM, 3/8" T1 Male NPTF  
**DVC 1501-8-8** – 1/2" T2 Female NPSM, 1/2" T1 Male NPTF  
**DVC 1501-12-12** – 3/4" T2 Female NPSM, 3/4" T1 Male NPTF  
**DVC 1501-16-16** – 1" T2 Female NPSM, 1" T1 Male NPTF

#### 45° Male Pipe by Female Pipe Swivel



**DVC 1503-4-4** – 1/4" T2 Female NPSM, 1/4" T1 Male NPTF  
**DVC 1503-6-6** – 3/8" T2 Female NPSM, 3/8" T1 Male NPTF  
**DVC 1503-8-8** – 1/2" T2 Female NPSM, 1/2" T1 Male NPTF  
**DVC 1503-12-12** – 3/4" T2 Female NPSM, 3/4" T1 Male NPTF  
**DVC 1503-16-16** – 1" T2 Female NPSM, 1" T1 Male NPTF

#### Female Pipe by Female Pipe Swivel



**DVC 1405-2-2** – 1/8" T2 Female NPSM, 1/8" T1 Female NPTF  
**DVC 1405-4-4** – 1/4" T2 Female NPSM, 1/4" T1 Female NPTF  
**DVC 1405-6-6** – 3/8" T2 Female NPSM, 3/8" T1 Female NPTF  
**DVC 1405-8-8** – 1/2" T2 Female NPSM, 1/2" T1 Female NPTF  
**DVC 1405-12-12** – 3/4" T2 Female NPSM, 3/4" T1 Female NPTF  
**DVC 1405-16-16** – 1" T2 Female NPSM, 1" T1 Female NPTF



### BAND-IT JR. C002 TOOL

For application of Band-It Jr. Smooth I.D. Preformed Clamps  
**BDT C002** • 5.7 lbs.



### BAND-IT C001 TOOL

This standard tool can be bench or vise mounted and is used with the band bulk rolls or with the J001 adapter for the preformed clamps. This tool attaches the preformed clamps to the hose and coupling to make the most secure fitting possible to avoid all leaks and failures in the hose.

**BDT C001** • 5 lbs.



### BAND-IT JR. ADAPTER J001

The adapter is necessary when using the preformed clamps on the C001 tool. The adapter allows the clamp to be correctly formed and tail broken flush to the ring.

**BDT J001** • 2 lbs.



### CENTER PUNCH TOOL

T-handle screw tensioning tool for up to 5/8" wide preformed bands

**BDT T300** • 3.2 lbs.



### CENTER PUNCH TOOL

These ratchet action tensioning tools are for applying center punch and center punch open end clamps with a center punch lock.

**BDT S38** • 1 lb.



### POK-IT-TOOL

Lightweight pocket size tool for use with 1/4-3/8" width band. It applies tension and has a built-in cutter.

**BDT J020** • 1.5 lbs.



### BAND-IT SMOOTH I.D. CLAMPS

Band-it preformed stainless steel clamps.

**BDT JS240** - 3/4" ID x 1/2" thick • 1 oz.  
**BDT JS242** - 1" ID x 1/4" thick • 1 oz.  
**BDT JS243** - 1" ID x 3/8" wide • 2 oz.  
**BDT JS202** - 1 3/8" ID x 3/8" wide • 2 oz.  
**BDT JS204** - 1 1/4" ID x 1/2" thick • 2 oz.  
**BDT JS209** - 2 1/2" ID x 5/8" thick • 2 oz.  
**BDT JS205** - 1 1/2" ID x 5/8" thick • 2 oz.  
**BDT JS214** - 4 1/2" ID x 3/4" wide • 2 oz.  
**BDT JS219** - 8" ID x 3/4" wide • 2 oz.  
**BDT JS412** - 3 1/2" ID x 3/4" thick • 1/2 lb.

### WORM GEAR CLAMPS

#### STYLE HSS CLAMPS

All stainless construction 5/16" hexagon and screwdriver slotted screw.



No.	Diameter Range		Sh. Wt.
	From	To	
<b>DVC HSS8</b>	1/2"	29/32"	1 oz.
<b>DVC HSS10</b>	9/16"	1 1/16"	1 oz.
<b>DVC HSS12</b>	11/16"	1 1/4"	1 oz.
<b>DVC HSS16</b>	13/16"	1 1/2"	1 oz.
<b>DVC HSS20</b>	13/16"	1 3/4"	1 oz.
<b>DVC HSS24</b>	1 1/16"	2"	1 oz.
<b>DVC HSS28</b>	1 5/16"	2 1/4"	1 oz.
<b>DVC HSS32</b>	1 9/16"	2 1/2"	1 oz.
<b>DVC HSS36</b>	1 13/16"	2 3/4"	1 oz.
<b>DVC HSS40</b>	2 1/16"	3"	1 oz.
<b>DVC HSS44</b>	2 5/16"	3 1/4"	1 oz.
<b>DVC HSS48</b>	2 9/16"	3 1/2"	1 oz.

### WORM GEAR CLAMPS - STYLE MAH

Miniature all stainless construction with combination 1/4" hexagon and screwdriver slotted screw. 5/16" band width.

No.	Diameter Range		Sh. Wt.
	From	To	
<b>DVC MAH4</b>	7/32"	5/8"	1 oz.
<b>DVC MAH6</b>	7/16"	25/32"	1 oz.
<b>DVC MAH8</b>	1/2"	29/32"	1 oz.
<b>DVC MAH10</b>	9/16"	1 1/16"	1 oz.

### "T" BOLT

#### CLAMPS

##### Style STBC

**DVC STBC188** from 1.724" to 1.942"  
**DVC STBC200** from 1.844" to 2.062"  
**DVC STBC225** from 2.094" to 2.312"  
**DVC STBC250** from 2.344" to 2.562"  
**DVC STBC275** from 2.516" to 2.812"  
**DVC STBC300** from 2.766" to 3.062"  
**DVC STBC325** from 3.016" to 3.312"  
**DVC STBC350** from 3.266" to 3.562"  
**DVC STBC375** from 3.516" to 3.812"



**DIXON STANDARD  
DRY GAUGES-  
ACCESSORIES**

1.5% accuracy, black steel case, acrylic crystal, black aluminum pointer, 1/4" lower mount.

- DVC GL115 - 0-30 PSI, 1 1/2" Face • .5 lb.
- DVC GL120 - 0-60 PSI, 1 1/2" Face • .5 lb.
- DVC GL320 - 0-30 PSI, 2 1/2" Face • .5 lb.
- DVC GL325 - 0-60 PSI, 2 1/2" Face • .5 lb.
- DVC GL330 - 0-100 PSI, 2 1/2" Face • .5 lb.
- DVC GL335 - 0-160 PSI, 2 1/2" Face • .5 lb.
- DVC GL340 - 0-200 PSI, 2 1/2" Face • .5 lb.
- DVC GL345 - 0-300 PSI, 2 1/2" Face • .5 lb.
- DVC GL350 - 0-600 PSI, 2 1/2" Face • .5 lb.



**GG SERIES GLYCERIN-FILLED GAUGE**

Designed for use with air, gas, oil and water. Brass movement, phosphor bronze Bourdon tube, black enameled aluminum pointer, white background dial, acrylic window. 2 1/2" face. Stem size 1/4" NPT connection and U-clamp.

**SILICONE-FILLED PRESSURE GAUGE**

- Silicone-filled gauge
- Stainless Steel Case
- 2 1/2" Face
- 1/4" NPT (M) Fitting
- Bronze Bourdon Tube
- Dual Scale Dial
- Brass Stem
- Clear Acrylic Lens

PSI	Hypro Model	WT.
0-60	HYP WGG60C	.5 lbs.
0-100	HYP WGG100C	.5 lbs.
0-160	HYP WGG160C	.5 lbs.
0-200	HYP WGG200C	.5 lbs.
0-300	HYP WGG300C	.5 lbs.
0-400	HYP WGG400C	.5 lbs.
0-600	HYP WGG600C	.5 lbs.
0-1000	HYP WGG1000C	.5 lbs.
0-1500	HYP WGG1500C	.5 lbs.
0-2000	HYP WGG2000C	.5 lbs.
0-3000	HYP WGG3000C	.5 lbs.
0-5000	HYP WGG5000C	.5 lbs.
0-6000	HYP WGG6000C	.5 lbs.

PSI	BAR	Hypro Model	WT.
0-60	4	HYP 2640-0009	.5 lbs.
0-100	7	HYP 2640-0010	.5 lbs.
0-200	14	HYP 2640-0011	.5 lbs.
0-300	21	HYP 2640-0007	.5 lbs.
0-600	42	HYP 2640-0008	.5 lbs.
0-1000	70	HYP 2640-0001	.5 lbs.
0-1500	105	HYP 2640-0002	.5 lbs.
0-2000	140	HYP 2640-0003	.5 lbs.
0-3000	210	HYP 2640-0004	.5 lbs.
0-5000	350	HYP 2640-0005	.5 lbs.
0-10000	700	HYP 2640-0014	.5 lbs.

**Magnifiers**

**OPTIVISOR**

Optical glass, binocular-magnifier. Lightweight, durable with adjustable head-band. Supplied with #10 lens plate which magnifies 31/2X at a focal length of 4". Optional OptiLoupe available to increase to 2-1/2X the power.

- DON DA10 - Optivisor • .75 lb.
- DON LP1 - OptiLoupe • 4 oz.



**DONEGAN  
OPTICAL  
MAGNIFIERS**

Folding pocket magnifier with multiple lens in plastic case. This dual lens model produces three magnifying strengths: 4X, 5X and 9X.

- DON P949



**CODDINGTON  
MAGNIFIER**

Double lenses mounted in chrome plated case. 23mm lens, 10X magnification.

- DON V309-23



**SPRAYER CALIBRATION  
CONTAINER**

2 Liter capacity  
SSC CP24034A-PP



**TEEJET® TIP CLEANING  
BRUSH**  
SSC CP20016-NY



**INCIDE OUT SPRAY TANK CLEANER**

Liquid spray tank cleaner formulated to emulsify pesticide residues and bond them to the rinse solution for a more thorough cleanout of residues from sprayer systems.

- Manufacturer approved
- Eliminates unwanted pesticide residues from sprayer system
- Reduces the risk of damage to non-target plants
- Won't clog nozzles or damage pumps like dry tank cleaners
- Low use rate
- Convenient to use packaging

- PLI 434-32 - 1 quart container

**NEW LA CROSSE  
WIRELESS TEMPERATURE STATION**



Min/max records for temperature with date/time stamp. Atomic time & date set automatically. Includes 1 remote sensor but can receive up to 3. Wireless outdoor temp. range: -39.8° F to 157.8° F, Indoor temp. range: 32° F to 139.8° F. Transmission range: up to 330'. Requires AAA batteries  
**LAC WS-9080U-IT**  
**LAC TX29U-IT** - additional sensor

**LA CROSSE  
WIRELESS RAIN CENTER**



Self-emptying rain bucket - empties via internal tilting cups. Measures total rainfall, and past 24 hours rainfall. Light-heavy rainfall indicator icons and rain alarm. Transmits up to 330'.  
**LAC WS-9004U-IT**

**LA CROSSE  
HANDHELD ANEMOMETER  
MEASURES WIND SPEED**



Registers maximum and average wind speed. Displays wind chill and temperature in °F or °C. Will show wind speed of .44 mph to 67 mph. Back lit with battery saving auto off. Neck band included.  
**LAC EA-3010**

**WATER SENSITIVE PAPER**

These specialty coated papers are used for evaluating distributions, swath widths, droplet densities and penetration of spray into the crop canopy. Water sensitive paper is yellow and stains blue when exposed to aqueous spray droplets. For information on water sensitive paper ask for information sheet 20367.



Water Sensitive Paper		
Part No.	Paper Size	Package
SSC 20301-1N	3"X1"	50 cards
SSC 20301-2N	3"X2"	50 cards
SSC 20301-3N	20"X1"	25 strips



**Avoid over and under application of chemicals**  
**Accurate flow rate measurements in seconds!**

- **Quickly find worn spray nozzle tips** - Industry guidelines recommend tip replacement once flow rate exceeds that of a new tip by 10%.
- **Accurately measure true tip flow rate** - Today's high tech sprayers can only be properly calibrated and confirmed with this knowledge.
- **Fast and simple operation** - Readings in 10 seconds or less per trip.
- **Easy to read digital GPM display**

- SPO 23890 - SC1 Sprayer calibrator • .52 lbs.

INSTRUMENTS



**SAF-T-FIT® Plus**

- Foil sealing flange and exhalation valve
- Nose bridge provides the wearer increased comfort and fit
- Lightweight, humidity-resistant, latex-free media for lower breathing resistance:  
60% improvement in measured fit factors  
42% lower exhalation breathing resistance  
34% lower inhalation breathing resistance
- NIOSH-approved N95 protection

**SPE 14110428** - M/L  
**SPE 14110429** - XL



**SAF-T-FIT® Flat Folds N95**

- Economical Mask
- Folds flat for easy storage and transportation in a pocket
- Individually packaged respirator springs open for quick donning
- Boomerang Nose seal
- Latex free
- Exhalation valve for exceptional comfort
- NIOSH-approved N95 protection

**SPE 14110323** - S  
**SPE 14110324** - M  
**SPE 14110325** - L



A full face respirator offered in a comfortable, high grade soft silicone assembly. The panoramic polycarbonate lens provides an unobstructed peripheral view, reducing blind spots (ratchet-type harness). The unique tight-seal suspension creates a balanced and comfortable fit. The bayonet connector is compatible with the replaceable T Series cartridges and filters. Ease of maintenance with its simple disassembly. ANSI Z87.1-1989 impact, penetration and optical requirements.

*Supplied with one set (2) of organic vapor cartridges (T01) and one set (2) of filters (R95) complete with 2 filter retainers (RP22R).*

**SET 821000-S** - Small facepiece with Tite-Seal Headgear  
**SET 822000-M** - Medium facepiece with Tite-Seal Headgear  
**SET 823000-L** - Large facepiece with Tite-Seal Headgear  
Each weighs 1.5 lbs.

**Survivair Opti-Fit™ Full Face Respirator**



A full face respirator that provides excellent visibility. It has a comfortable, superior fit with a state-of-the-art replaceable lens. The nose cup is a standard feature to prevent fogging, and durable silicone skirt is comfortable to wear. NIOSH approved. Uses T Series cartridges and filters.

*Supplied with one set (2) of organic vapor cartridges (T01) and one set (2) of filters (R95) complete with 2 filter retainers (RP22R).*

**SET 758000-S** - Small Basic Facepiece  
**SET 768000-M** - Medium Basic Facepiece  
**SET 778000-L** - Large Basic Facepiece  
Each weighs 1.25 lbs.

RESPIRATORS



**Powered air purifying helmet respirator for personal respiratory protection while spraying. All are battery run up to 4 hours with flip up visors on fiberglass shell**



**PROF 88** - Self contained helmet; ideal for growers who are walking or driving and applying pesticides. Use in orchard, field or greenhouse. Fan, batteries and filters are built into helmet. Comes with two ZA1/P3 pesticides filters. SP88 12V power cord for lighting socket, fan, filters and batteries.

**KAS 0313072** - PROF88 • 4.5 lbs.  
**KAS 0601047** - Hepa Filter ea.



**K80S-T8N** - Choose tractor/truck powered unit (T) or the battery powered portable unit (G). Similar units, yet the T helmet is powered using 12V power cord and the G unit is powered directly off the portable battery pack. Both can be worn with beards and glasses and are pressurized by positive pressure with 8 cfm. Comes with two ZA1/P3 pesticide filters, SP88 12V power cord for lighting socket, fan filter and batteries.

**KAS 0313141** - K80S-T8N(T) • 8.5 lbs.  
**KAS 0313195** - K80S-T8N(G) • 8.7 lbs.  
**KAS 0601047** - Hepa Filter ea.

### Survivair Premier® Half Mask Respirator



High quality silicone respirator available in three sizes with soft sealing flange. Elastic head straps adjust for easy fit and unobstructed vision. Low profile nosepiece allows for compatibility with eyewear. Perspiration port reduces facepiece slippage and skin irritation. Replaceable parts. Use T Series cartridges and filters. NIOSH approved.

**SET 311000-S** - Small • 1 lb.

**SET 312000-M** - Medium • 1 lb.

**SET 313000-L** - Large • 1 lb.

### Survivair VALUAIR® Plus Half Mask Respirator



For limited life applications without sacrificing comfort and fit. The thermoplastic elastomer facepiece reduces cost while giving you a soft sealing flange and forward angled nosepiece to accommodate eyewear. It has simple, easy to adjust sliding suspension. Replaceable parts. Use T Series cartridges and filters. NIOSH approved.

NIOSH approved.

**SET 301000-S** - Small • 1 lb.

**SET 302000-M** - Medium • 1 lb.

**SET 303000-L** - Large • 1 lb.



RESPIRATORS

#### ALL RESPIRATORS REQUIRE A SET (2) OF CARTRIDGES & A SET (2) OF FILTERS

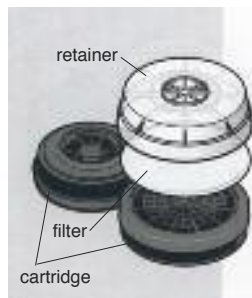

#### Cartridges:

- The organic vapor cartridges (T01) are bayonet (1/4 turn) mounted to the respirator
- The cartridge should be replaced when no longer servicable as determined by the owner and/or supervisor, or an OSHA change schedule, or earlier if a contaminant is detected by smell, taste, irritation or if there is damage to the cartridge.
- Always replace cartridges in pairs
- Store cartridges in a sealed containment device (bag) to insure longer cartridge use.
- NIOSH approved

**SPE T100100** - cartridge (T01)

#### Filters:

- Filters (R95) are mounted to the cartridge using a filter retainer (RP22R)
- The filter should be replaced when no longer servicable as determined by the owner and/or supervisor or when damaged, soiled, contaminated with water, or causing increased breathing resistance and discomfort.
- Filter replacement is normally twice as frequent as the cartridge.
- NIOSH approved.

**SPE T117010** - filter (R95)

**SPE 14900975** - retainer (RP22R)

### Sight Savers®



Anti-fog formula pre-moistened tissues for non-coated lenses. Cleans glass and plastic. Anti-static. Contains silicone. Not for use with contact or coated lenses.

Sold individually or by the box (100). Packet contains one tissue each.  
**SPE 981808**



**Coveralls**

Lightweight, breathable fabric that is strong and abrasion resistant for extended wear. Good protection against dry particulates and light liquid sprays. Ideal for general maintenance, cleanup, food processing and dusty environments. Not normally used for spraying. Zipper front style, no hood. 24 per case. Also sold individually. White.

**NO HOOD**

- KIM 49002** - Medium
- KIM 49003** - Large
- KIM 49004** - XLarge
- KIM 49005** - XXLarge



**Select Coveralls**

A strong and breathable 3-layer fabric designed to offer protection against fine dusts, fibers and low surface liquid splashes. CA approved for pesticide application garment. Ideal for painting, spraying, maintenance, and handling grease and oils. Denim Blue, 24 per case. Zipper front, elastic back, wrists and ankles.

**NO HOOD**

- KIM 58502** - Medium
- KIM 58503** - Large
- KIM 58504** - XLarge
- KIM 58505** - XXLarge

**HOOD**

- KIM 58512** - Medium
- KIM 58513** - Large
- KIM 58514** - XLarge
- KIM 58515** - XXLarge



**A70® Coveralls**

A polyethylene-coated fabric. Lightweight and resistant to many water-based liquids, greases, oils, liquid splashes and sprays. CA approved for protection in pesticide applications. Use when warning label reads "chemical resistant garment when spraying or mixing is required by label". Liquid-resistant extra long zipper and taped storm flap. Made with NFPA 99 compliant antistatic material; includes coveralls with hood. Yellow.

**HOOD**

- KIM K4509812** - Medium
- KIM K4509813** - Large
- KIM K4509814** - XLarge
- KIM K4509815** - XXLarge



Hood



No Hood

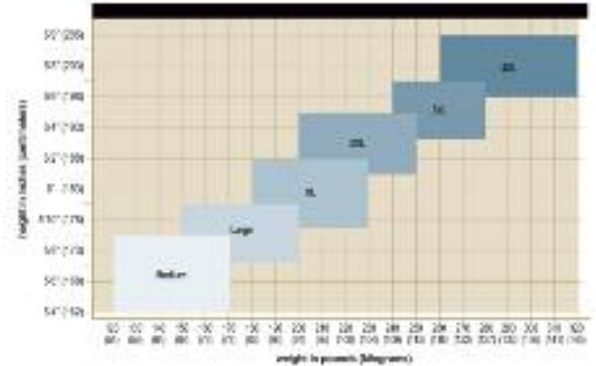

Note: If pesticide warning label reads "coveralls required" KleenGuard or Kleenguard Select are acceptable. If warning label reads "chemical resistant garment required" Repel is the fabric to use. Special Note: For blood borne pathogen rated garments use KleenGuard Ultra, available by special order only. Other styles and garments available by special order.

PERSONAL PROTECTION

	Alpha Size Numerical Size	Small 36-38	Medium 36-38	Large 36-38	XLarge 36-38	XXLarge 36-38
<b>Jackets</b>	<b>Chest</b>	<b>44</b>	<b>48</b>	<b>52</b>	<b>58</b>	<b>60</b>
	<b>Sleeve</b>	<b>27</b>	<b>28</b>	<b>29</b>	<b>30</b>	<b>31</b>
	<b>Length</b>	<b>30</b>	<b>30</b>	<b>30</b>	<b>30</b>	<b>30</b>
<b>Overalls and Pants</b>	<b>Waist</b>	<b>36</b>	<b>38</b>	<b>42</b>	<b>46</b>	<b>48</b>
	<b>Inseam</b>	<b>28</b>	<b>29</b>	<b>30</b>	<b>32</b>	<b>32</b>

**Classic Rainwear**

Yellow classic rainwear constructed of .35 mm PVC. It has welded seams, storm flap over snap front closure, detachable drawstring hood, take-up-snap wrists, ankles and waist. Finished with a rounded collar, raglan sleeves, cape ventilated back with 3 mesh holes, and two pockets. Excellent value and very versatile. Choose size when ordering: M, L, XL, XXL

**RIV 2403-(size)** - 3 piece suit

**NEW**



**Lined Protective Clothing**

Heavy duty lined Yellow PVC stretch outer fabric is bonded to a lightweight liner for comfort. Lasts and lasts! Washable.

**Hooded jacket with storm flap**  
Sizes: M, L, XL, XXL  
**EDM 65-550**

**Yellow jacket with velvet collar**  
Sizes: M, L, XL, XXL  
**EDM 65-560**

**Bib Overalls**  
Sizes: S, M, L, XL, XXL  
**EDM 65-555**

**Hood (snaps to jacket with velvet collar)**  
One size  
**EDM 65-561**



**NEW**

Protection you can trust



**AM/FM Stereo Radio Earmuffs**  
Our AM/FM radio with MP3 connection features superior radio sound quality with a noise reduction rating of 23 dB. This new model has an improved lightweight design and comfortable adjustable headband. The automatic shut-off feature extends the life of the batteries.

Professional grade.  
Comes with 2 AA batteries.

*Give your ears a treat!  
Add music to your day!*  
**SPE RWS-53005** • 20 oz.

**NEW**



**High Performance Muff**  
Provides excellent full spectrum attenuation as well as superb low noise reduction. It comes with a fork type headband for even distribution of pressure with a soft padded head cushion for the highest degree of comfort. It has improved balance and extra deep ear cups. Tests 29 dB NRR.

**ELV HB-650** • 11 oz.



**ValueMuff™**  
A basic ear muff at a very reasonable price that is comfortable, great looking with a noise reduction rating of 25 dB. It has soft and pliable SuperSeal ear cushions with a solid, durable headband.

**ELV HB-25** • 8 oz.

**Millennia™**

Lightweight nylon frame with good side and brow protection. It comes with a high impact wrap-around lens that has a scratch-resistant hardcoat. Adjustable break-away flexicord included. Meets ANSI Z87 code. 1 oz..

- SPE 11150750** - Clear lens
- SPE 11150751** - TSR gray lens (shown)
- SPE 11150754** - Silver mirror lens



11150751



**XTS™**

Our Extraterrestrial (XTS) safety glasses with an updated design, great fit and coverage is Ballistic Vo rated and complies with ANSI Z87.1-2003. Anti-slip rubber temple tips and a choice of frame colors. 99% coverage against UV light. Hardcoat PC lens. A best seller and a top of the line safety glass. 1 oz.

- ELV SG-24-I/O** - indoor/outdoor
- ELV SG-24M** - silver coated

**NEW**



**Xenon™**

Lightweight stylish safety glass with a rubber nose bridge and colorful rubber inserts at temples. A good looking pair of glasses. Tested to ANSI Z87.1-2003. 0.8 oz.

- ELV SG-14B** - ice blue
- ELV SG-14C** - clear
- ELV SG-14G** - gray
- ELV SG-14M** - flash mirror



SG-14C

SG-14G

**Bifocals**

Combining a safety glass as a safety reader is a brilliant idea, and these are some of the best out there. Comfortable with a soft rubber nose bridge and temple inserts, these bifocals are available in three lens variations in a golden brown frame. ANSI Z87.1 compliant. 1.2 oz.



- ELV RX-350C-1.5** - Bifocal strength
- ELV RX-350C-2.0** - Bifocal strength
- ELV RX-350C-2.5** - Bifocal strength

**NEW**



**Visionaire® Goggle**

High performance goggle with polycarbonate lens with inside anti-fog treatment, four ventilation slots, extra wide strap - all with a comfortable fit. Meets ANSI Z87 safety standards.

- ELV GG-30-AF** • goggle
- ELV RL-30-AF** • replaceable lens

**Ear Pods**

One of our customers found these for us! Much improved over the others, these fit so comfortably; smooth and ergonomic pods fit in the ear for maximum protection. The band design prevents ear pods from touching dirty or contaminated surfaces when set down. NRR 27 dB

- SPE QB1HYG** - band
- SPE QB100HYG** - replacement pods



**NEW**

**Disposable Ear Pods**

CA foam plug that is easy to use and provides excellent attenuation is visually easy to monitor with multi-lingual packaging. They are easy to insert correctly with a tapered shape and slow expansion rate. Preserve your hearing! Rated NRR of 32 dB.

- ELV EP-201** - Box, 200 pair
- ELV EP-211** - Box-corded, 100 pair



EYE/EAR PROTECTION



**Lined Pigskin Gloves**  
Open cuff KCO 1927. Innovators of "The Original" lined grain pigskin leather, this glove has a trademarked material back and cuff with the warmth of a Heatkeep™ lining. Choose Men's M, L, XL  
**KCO 1927** - Lined



**Lined Knit Wrist Gloves**  
Just like glove mentioned above, but with a comfortable knit wrist. Keep your hands warm and dry. Compared to cowhide, pigskin will stand up to twice the abrasion and wear. Choose Men's S, M, L, XL  
**KCO 1927KW** - Lined



**High Visibility Gloves**  
Warm, grain pigskin glove with waterproof insert. Triple layers protect against cold and wet. 3M Scotchlite™ Reflective Material with knitted cuff. Choose Men's M, L, XL  
**KCO 1939KWP**



**Lined Pigskin Gloves**  
Heatkeep® lined pigskin grain/suede gloves are great for wind protection. Snug knit wrist, keystone thumb. Choose Men's S, M, L, XL  
**KCO 94HK**



**Thermal Gripping Gloves**  
Thermal lined gripping gloves – great for picking up wet materials, fall cleanup and other damp working conditions. Has a sure-grip palm with breathable back. 100% acrylic knitted shell, Latex coated palm. Fantastic glove. Choose Men's S, M, L, XL  
**KCO 1790**  
Choose Women's S, M  
**KCO 1790W**



**Winter Work Gloves by Edmont**  
Raised finish red fluorescent vinyl coated gloves with knit cuff. Non-woven insulate lining. Good safety and high visibility glove. Size 10 only.  
**EDM 523-471**



**Leather Palm Gloves**  
Strong, grain pigskin leather and rubberized cuff mark the features of a remarkable all-purpose glove. Leather dries soft. Unlined. Choose Men's S, M, L, XL – Unlined  
**KCO 1917**



**Leather with Knit Wrist**  
The same glove as above, but with a knit wrist. **BEST GLOVE OUT THERE!** Choose S, M, L, XL - Unlined  
**KCO 1917KW**



**Golden Knit**  
A durable working glove with PVC webbing on palm and back with reversible thumb. Choose Men's S, M, L, XL.  
**KCO 1778**

**PVC Gloves**

Long 18" smooth PVC gloves with cotton interlock lining. Black in Men's Large only. The long gauntlet provides added protection.  
**KCO 7388**



**PVC Gloves**

Long 14" gauntlet non-slip PVC gloves with a thermal foam lining. Fluorescent orange in Men's Large only, useful working with high temperature liquid.  
**KCO 4184**



**Edmont Gloves**

**Nitrile Gloves**

Embossed, straight cuff, chemical & solvent resistant gloves. Unlined. Available in 2 lengths. 13" gloves 15 mils thick in Men's XS, S, M, L, XL  
**EDM 37-155**  
18" gloves 22 mils thick in Men's S, M, L, XL  
**EDM 37-185**



**Monkey Grip Gloves**

Raised finish winter vinyl coated gloves with safety cuff. Non-woven insulated lining. For yard and field work; snow and water resistant. Size 10 only.  
**EDM 523-173**



**Golden Grab-It Gloves**

Premium coated crinkle finish general purpose work gloves. Cut resistant. Size 10 only.  
**EDM 16-347**



**Disposable Nitrile Gloves**

Lightly powdered, rolled cuff disposable Nitrile gloves four mils thick, 9 1/2" long. Nitrile is chemical resistant, gives better protection against puncture and abrasions than PVC or polyethylene gloves. Packed 100 gloves in a dispenser box. Fits either hand. Choose S, M, L, XL.  
**KCO 2350**



GLOVES

**West County Gardener** provides high quality gloves and relies on fewer non-renewable resources. Every pair of West County gloves removes one large plastic water bottle from the landfill, saves energy and produces at least 40% less CO<sup>2</sup>.



### Classic Gloves

Made from high-tech recycled materials, but has a more luxurious look and feel. Attributes: a long cuff, adjustable wrist, comfortable, breathable, and durable.

Women's sizes.  
**WCG 074S** - Slate XS, S, M, L, XL  
**WCG 074B** - Berry XS, S, M, L, XL



### Landscape Gloves

Kevlar™ reinforcements with dense foam padded palm insert for shock absorption. Flexible compressed Neoprene knuckle protection. Gripper dots on palm for better grasp.

**WCG 043** - Women's Stem S, M, L,  
**WCG 048** - Men's Charcoal or Stem M, L, XL



### Rose Gloves

Full elbow length gloves with reinforced fingers & palm, and lightly padded palm. Made of 100% synthetic suede, lightweight, breathable and washable.

Unisex sizes.  
**WCG 054R** - Ruby XS, S, M, L, XL  
**WCG 054M** - Moss XS, S, M, L, XL



### Waterproof Gloves

Voted the Best overall waterproof glove by the Wall Street Journal, this glove is made with a spandex mesh back using 95% recycled materials. It is perfect for use in cold, wet weather.

**WCG 015** - Women's Black S, M, L, XL  
**WCG 018** - Men's Black S, M, L, XL



### Work Gloves

Durable with padded palm 4-way stretch nylon back, reinforced stress points and a terry cloth brow wipe. Very versatile and an all around favorite. Now made with 95% recycled materials.

**WCG 014** - Women's Iris or Teal XS, S, M, L  
**WCG 019** - Men's Charcoal L, M, XL, XXL

**Choose color and size when ordering**



BERRY BLACK CHARCOAL GOLD IRIS MOSS RUBY SLATE STEM

**NEW**

### Bamboo Gloves



Terrific new bamboo gloves with Latex coated palm and fingers and threaded color bamboo knit shell. Snug elastic knit wrist, comfortable and environmentally friendly.



Men's  
**KCO 1781** - M, L, XL • olive green



Women's  
**KCO 1781W** - S, M, L • purple

### Nitrile Gloves

Nylon, breathable knitted shell with smooth finish and Nitrile coated palm and fingers. Excellent for garden planting and weeding. Form fitting and washable.



**KCO 1891** - S, M, L  
 Women's purple and rose



**KCO 1890** - S, M, L, XL  
 Men's navy blue



### Lightweight Gripping Gloves

Breathable, gray poly/cotton knitted shell with blue latex coated palm. Comfortable elastic knit wrist and a great choice when you need a lighter weight glove. Washable.

**KCO 1791** - S, M, L, XL

## KIDS • KIDS • KIDS



### Lined Work Gloves

Lined soft ultra suede palm material and trademark striped back. Knit wrist and warm, fleecy lining for cold weather.

**KCO 1927KWC** - Ages 3-6  
**KCO 1927KWY** - Ages 7-12

**NEW**



### Lined Mittens

Soft and durable ultra suede mitten with warm fleecy lining for cold weather. Shirred elastic wrist for a snug fit. Adorable!

**KCO 1930C** - Ages 3-6

**NEW**



### Cowhide Leather Palm Gloves

Gray cowhide leather palm with rubberized safety cuff and wing thumb. Terrific first work glove!

**KCO 1500C** - Ages 3-6  
**KCO 1500Y** - Ages 7-12



### Latex Dipped Gloves

Green latex palm and fingers with comfortable cotton shell. Get the kids planting and keep their hands clean!

**KCO 1785C** - Ages 3-6  
**KCO 1785Y** - Ages 7-12

GLOVES

# BUZZ OFF™

**insect shield** +  
insect repellent apparel

## Buzz Off Insect Shield

Binds permethrin (a man-made version of the natural insect repellent found in chrysanthemums) tightly to fabric fibers, resulting in effective, odorless insect protection. Our bandana's have been very popular and are available in 3 great colors.

Good for at least 25 washings, it will keep mosquitoes and pesky gnats at bay. EPA registered. Quit going through the torture! 2.3 oz.

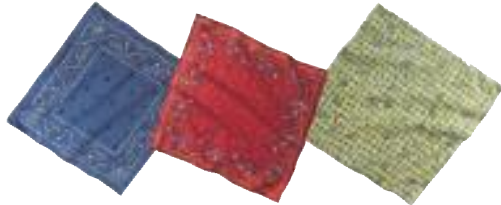

**Water Paisley** BUZ 3353-0335  
**Rose Butterfly** BUZ 3353-0334  
**Garden Check** BUZ 3353-0336

**NEW**



## Waterproof LED Flashlight

Waterproof and also shock resistant. It has 7 bright LED bulbs with 3 functions: Low beam, high beam, and flashing beam of light. Uses three AAA batteries (not included). Includes wrist band.

**BTB FL3031WS-B** - Flashlight • 2.7 oz.



## SCRUSHER™

Hard maple brush mounts with two side brushes of soft poly and two bottom brushes of stiff poly. 5 year warranty on black steel frames. Leave the dirt and mud outdoors.

**SCR H1** – Original Scrusher • 4 lbs.  
Original Scrusher mounted to tubing to fit 2" hitch receiver. 17"x6"x10"  
**SCR H1RH** – Tailgate Scrusher 8 lbs.

## HAND & TOE WARMERS

All day, air activated, time released, disposable hand and toe warming packs. Each soft, lightweight pouch contains a mixture of iron powder, water, vermiculite, cellulose, activated carbon and salt. Oxidation causes a safe, natural reaction to release heat. Keep in zip-seal polybag to preserve for days. Warms in minutes. Biodegradable. Keep your hands and toes warm!!

**OCC 1100-80D** - Hand warmers,  
Quantity of 5 pair per pack  
**OCC 1106-40D** - Toe warmers,  
Quantity 1 pair per pack

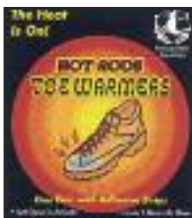

## The BugBand Wristband

Protects you from mosquitoes, flies, gnats, no-see-ums and ticks. Wear it on your wrist, ankle, baby stroller, belt loop, etc. Don't leave it behind when going to an outdoor event! Contains Geraniol (oil extracted from geranium oil) is water resistant and DEET free; works up to 120 hours, is packaged in reusable plastic pod, and comes in multiple colors. 0.6 oz.

**BUG 88207** – blue  
**BUG 88205** – green  
**BUG 88202** – pink  
**BUG 88203** – red  
**BUG 88204** – yellow



**NEW**

**NEW**

## BugBand Pump Spray

Mists Geraniol vapors that form a protective barrier to deter blood-sucking insects from biting. Use once for hours of insect protection.

**BUG 88336** – Spray lotion • 6 oz.



## YAKTRAX.



## YakTrax Pro

Heavy duty rust resistant steel coils provide forward and backward stability while you navigate ice and snow conditions. Easy on and off, lightweight, durable and flexible. Adjustable strap helps to keep it in place. Work confidently on packed snow and ice with the Pro! Black. 5.5 oz.

*Shoe size*

**YAK PB-S** - Small Men's 5-8.5 / Women's 6.5-10  
**YAK PB-M** - Medium Men's 9-11 / Women's 10.5-12.5  
**YAK PB-L** - Large Men's 11.5-13.5 / Women's 13-15

## Traction 360®

Walk confidently on wet and greasy floors with 360° of traction! The patented non-slip design works in extreme temperatures. Keep in mind that according to the National Safety Council, the average cost per slip/fall accident was \$20,228 last year. Save yourself from the grief of injury while still wearing your favorite footwear.

**NEW**



*Shoe size*

**YAK 08500-S** - Men's 6-7.5 / Women's 7.5 - 9  
**YAK 08501-M** - Men's 8-10 / Women's 9.5-11.5  
**YAK 08502-L** - Men's 10.5-12 / Women's 12-13.5

## Native Plants of the Northeast

A fabulous guide for gardening and conservation. With entries for nearly 700 species of native trees, shrubs, vines, ferns, grasses, and wildflowers from the northeastern quarter of the U.S. and eastern Canada, its comprehensive horticultural coverage is unsurpassed by any other single volume. *By Donald Leopold*

**BOK 682673** – Native Plants of the NE • 2.8 lbs.



**NEW**

HEAD TO TOE PROTECTION

**OUR OWN HEAVY DUTY BLACK POLYETHYLENE TREE GUARD**

Black, flexible, extruded polyethylene material is UV protected. This tree guard provides abundant light penetration, air circulation, and spray deposit capability for the fruit tree trunk. Easy to handle and cut to shape, this guard provides protection from voles, rabbits, and rodents when installed properly. Molded plugs speed installation. Approximately 3 1/2 diamonds per inch. Roll is 20" wide X 100' long. Approximately 60-70 guards per roll. **JDR 6715-10 • 26 lbs.**



**2" WOOD TREE STAKES**

2" round, pointed, pressure treated lodgepole pine tree stakes. Sold singly, by the bundle or by the truckload.

**JAS 2X8LP - 8'**  
**JAS 2X10LP - 10'**



**Larger poles available by special order**



**PRESSURE TREATED POSTS**

4" and 5" blunt-ended posts. Available in .40 CCA or .60 CCA (by special order). Sold singly, by the bundle or by the truckload.

**JAS 4 x 10 ft.** Other lengths & sizes available by special order.  
**JAS 4 x 12 ft.**  
**JAS 5 x 10 ft.**  
**JAS 5 x 12 ft.**



Locking buttons for JDR 6715-10 tree guard. Pkg. 200 molded plugs **LEE P0004 • .25 lb.**

**METAL TREE PROTECTION**

Metal tree guards measure 10" x 18" flat. They are a punched stainless steel with rubber backing. Available flat or rolled.

**Excellent for protection against trimmer damage**



**JUD 1 - 10" x 18", Flat • .5 lb.**  
**JUD 2 - 10"H x 6" dia., Rolled • .5 lb.**  
**JUD 3 - 18"H x 3" dia., Rolled • .5 lb.**  
**GRA 6x750 Nylon Ties - 100/bag • .5 lb.**

**SPIRAL TREE GUARD**

Protection for fruit and ornamentals from animal and mechanical injury. White spiral special plastic expands to trunk size. 250 in a case.

**GRD C270WE-18 - 18"**  
**AML 24TP - 24"**



**Paper Tree Wrap**

4"x150"  
10 rolls/carton  
**CLA 00304**



**STAKE DRIVER**

For driving wood or metal stakes into the ground. Will prevent splitting of wooden stake heads.



**Order Online**

**WWM 22 • 19 lbs.**

**SURE GRIP EARTH ANCHORS**

Painted anchors with a solid welded eye and sturdy welded helix.

**30" x 1/2" x 4"**  
**OVS 30-inch**

**40" x 5/8" x 6"**  
**OVS 40-inch**

**48" x 3/4" x 6"**  
**OVS 48-inch**



**DUCKBILL EARTH ANCHORS**

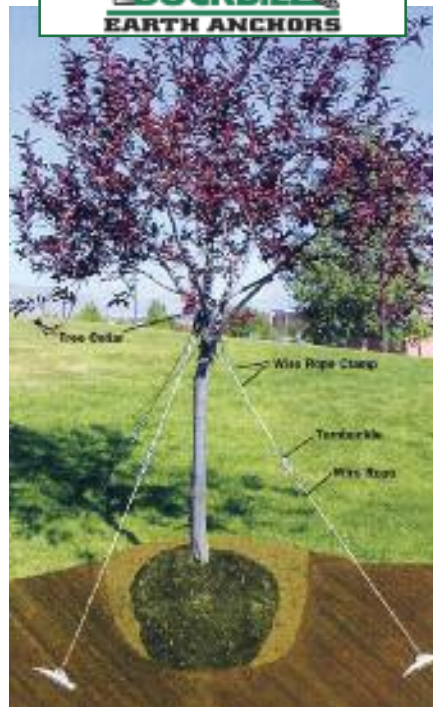

**Duckbill Kits contain 3 Duckbill anchors, cable to each anchor, collars and cable clamps for each cable**



**DUC 40DTS - up to 3" caliper trees, 12' cables**  
**DUC 68DTS - up to 6" caliper trees, 13' cables**  
**DUC 88DTS - up to 10" caliper trees, 15' cables**

**Duckbill anchors only - just anchor with shorter cable**

**DUC 40DB1 - 300# cap, 20" of 1/16 gal. steel cable attached. 50/box**

**DUC 68DB1 - 1100# cap, 30" of 1/8 gal. steel cable attached. 24/box**

**DUC 88DB1 - 3000# cap, 42" of 1/4 gal. steel cable attached. 12/box**

**DUC 138DB1 - 5000# cap, 60" of 6/16 gal. steel cable attached. 12/box**

**DUCKBILL® MANUAL DRIVE STEEL RODS**

**DUC DS 40 - 24" long steel rod with striking head**  
**DUC DS 68 - 36" long steel rod with striking head**  
**DUC DS 68HD - 48" long steel rod with large striking head**  
**DUC DS 88 - 48" long steel rod with striking head**

TREE PROTECTION/SUPPORT

## Wire and Cable

### High Tensile Galvanized Wire

200k PSI  
Class III Galvanized  
Approximately 4000'/roll  
**FRS 12.5-GAUGE** - 12 ga. • 100 lbs.  
**FRS 14-GAUGE** - 14 ga. • 90 lbs.



### Wire Care Clips

Attaches securely to posts with nail.  
Durable, U.V. resistant polyethylene Non-corrosive. Can be used for either up or down tension. Load bearing area of 10mm.  
**OVS WCC-1** - 200/bag



**NEW**

### Wire Spinning Jenny

Essential when working with large coils of high-tensile wire. Brake helps to prevent fouling and kinking of wire.  
**KEN TSJHH** • 21 lbs.

### **BF** Nylon Monofilament Wire

Black single strand nylon. High tensile, low stretch and 1/8<sup>th</sup> the weight of steel wire of the same gauge. Great for berry trellising and bird netting applications.



**BFP BF1408SP** - 8 ga. (0.166") x 500', 1093 lbs. tensile • 6 lbs.  
**BFP BF1408WS** - 8 ga. (0.166") x 3000', 1093 lbs. tensile • 37 lbs.  
**BFP BF1411WS** - 11 ga. (0.188") x 5000', 685 lbs. tensile • 34 lbs.  
**BFP BF1412SPL** - 12 ga. (0.100") x 1100', 493 lbs. tensile • 6 lbs.

### **BF** Staples

6" x 1" Ground staple  
**BFP BF142M** - 1000/box • 39 lbs.



2" Fence staple, 2" x .5"  
**BFP BF142B** - 48/lb. • 1 lb.



### Galvanized Wire Rope

Excellent for netting support.  
3 sizes - priced per foot  
**MVS 1/8-7X19**  
**MVS 3/16-7X19**  
**MVS 3/32-7X19**



### Malleable Clamps

**MVS 1/8** - cable clamp, 1/8"  
**MVS 3/16** - cable clamp, 3/16"  
**MVS 1/4** - cable clamp, 1/4"  
**MVS 3/8** - cable clamp, 3/8"  
**MVS 1/2** - cable clamp, 1/2"

### Crimp Sleeves for Wire and Cable

Steel sleeves for high tensile wire.  
**KEN C12** - 14/16 ga. - 100 count  
**KEN C23** - 12.5 ga. - 100 count



Aluminum sleeves for cable (match to cable diameter)  
**MVS 1/4-SLV**  
**MVS 3/16-SLV**  
**BFP BF049A** - 3/32-SLV  
**BFP BF049C** - 5/32-SLV

**NEW**

### How to Build Orchard and Vineyard Trellises

47 page how-to guide with clear illustrations.  
**BOK ABT**



### Seymour Fence Pliers

Multi-purpose alloy-steel head, forged steel handles.  
**SEY 2T-1900** • 23 oz.



### Felco C7 Wire and Cable Cutter

High quality hardened steel blades and center bolt. Stamped steel handle with non-slip grip. 7.5" OAL.  
**FEL C7** • 9.5 oz.



### Trellis/Wire Cutter

**KEN TCTHD** - 9" OAL • 12 oz.



### Crimping Tool

Works with all sizes of crimp sleeves  
**KEN TFFG** • 6.2 oz.

**NEW**



### Galvanized Brace Pins

Used in constructing H-braces at trellis row ends.  
**KEN H4PE** - 3/8" x 4" • 2 oz.  
**KEN H9PE** - 3/8" x 9" • 4 oz.

TRELLIS

**NEW**



**Kiwi Wire Strainers**

Original design with spring for safer tensioning. Hot-dipped galvanized, USA made.

**KEN SAS** • 0.6 lbs.



**Wire Tensioning Springs**

Springs act as a shock absorber and serve to maintain proper wire tension with changes in weather.

**KEN HTSHD** • 1.5 lbs.

**NEW**



**NEW**

**Hayes Chain Grab Tool**

Popular tool for tensioning high-tensile wire. Jaws grip smooth wire. Back and forth motion of the handle walks tool along chain removing slack in wire.

**KEN TCH** • 6.74 lbs.



**NEW**

**Universal Wire Strainer Handle**

**KEN TFU** • 1.15 lbs.



**Inline Wire Strainer**

Inline strainer can be installed without cutting wire. Great for removing slack or releasing wire tension with changes in temperatures

**KEN SSDN** • 7 oz.

**AgFast™** Trellis Hardware  
CORPORATION  
**WIREVISE®**

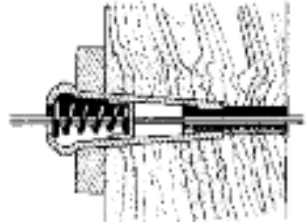

Use Wirevise to anchor wire to end posts. Tension by hand or with a Gripple Torq Tool

**AGF 5056V** - 13, 14, 15, 16 ga. (.062 - .10)

**AGF 5058V** - 12, 13 ga. (.102 - .114)

**AGF 5062V** - 10, 11 ga. (.120 - .135)

**AGF 5064V** - 8, 9 ga. (.148 - .163)



**Gripples**

**Gripping Wire Joiner and Tensioner**

Suitable for mild steel, high tensile steel or nylon monofilament wire. Re-tension as needed.

**KEN CGM** - 14-12 gauge, medium

**KEN CGL** - 12-8 gauge, large



**Tensioning Handle for Inline Strainers**

**KEN TFD** • 2.4 lbs.



Use Wirelink to splice wire. No tools required.

**AGF 5057V** - 13, 14, 15, 16 ga. (.062-.10)

**AGF 5059V** - 12, 13 ga. (.102-.114)

**AGF 5063V** - 10, 11 ga. (.120-.135)

**AGF 5065V** - 8, 9 ga. (.148-.163)



**Gripping Tensioning Tool**

Generates 880# of load. Torque tensioning feature allows you to tension the wire to a specific tension.

**KEN TGTP** • 2.4 lbs.



**2 TON CABLE PULLER**  
**WIR 67-PP2**



**Kline Wire Pulling Grips**

Use with a cable puller to grip high-tensile wire while tensioning wire.

**WIR KLIWIRE 161330** • 3 lbs.



**U-Hooks**

Used to hold trees and vines to trellis systems. Unique design prevents hook from sliding. Galvanized, will not expand as vine or tree grows. 2.5" or 3"

**WIR U-Hooks Small**

**WIR U-Hooks Large**

TRELLIS

### Tye Tube

Tough, UV stabilized vinyl product provides excellent strong tying material for vineyard, nursery, and orchard applications. It has good elasticity, allowing for plant growth without damaging the plant. Packaged on lightweight spools. 5/16"X340'

**WIR TT340** - 2 lbs.



### Arbor Tie

3/4" wide, strong, woven nylon tie. Material is similar to parachute shroud cord. Favorite of arborists. Olive green.

**WEB 3/4-250G** - 250' roll

**WEB 3/4-500G** - 500' roll

**WEB 3/4-1500G** - 1,500' roll

White color, special order only. Case lots only.



### Miracle Tie

A 1" wide, green, .012 mil thick tie for long lasting ties. This material is strong, pliable, easy to use and will not girdle or cut trees. 1" x 100' roll.

Available in 12 roll packs at discounted price.

**COO 3422**



### Superties

All plastic, all purpose, weatherproof, reusable, instant locking, adjustable and able to open again. 1001 home and garden uses.

**TYZ ST1** - 9/16" x 6" - 1000 pkg.

**TYZ ST2** - 9/16" x 8.5" - 1000 pkg.

**TYZ ST3** - 9/16" x 1000' - roll



### Hard Wood Clothes Pin

**NCP CLOPIN** - 100/bag, 1200/case



### Velcro®

#### One-Wrap® Brand Bundle Ties

Adjustable fastener for horticulture, viticulture and floriculture. Use one product for growing and training and produce bundling. Reusable hook & loop design construction. Moss green color hook, white loop backing. Great for brambles (blackberry, raspberry, currant). Other colors and sizes available on special order. Dispenser available. Imprint design by special order. 2" overlap recommended.

**VEL 162401** - 1/2"x75' roll



### Ring Knives

**ZEN RK-9** - ring size 9

**ZEN RK-10** - ring size 10

**ZEN RK-11** - ring size 11

**ZEN RK-12** - ring size 12

**ZEN RK-13** - ring size 13



**NEW**

### 4 Mil Flagging Tape - Various Colors

1/2" or 1" wide in various colors.

Order 12 or more rolls and save.

**NEW**



COLOR	1/2" x 130 feet	1" x 300 feet
WHITE	COO 3640	COO 3620
PINK-GLO	COO 3641	COO 3621
BLUE	COO 3642	COO 3622
YELLOW	COO 3643	COO 3623
RED	COO 3644	COO 3624
ORANGE-GLO	COO 3645	COO 3625

# AgFast™

CORPORATION

### TRELLIS TYING



### AgLok

A universal agricultural fastener. 1/16" thick, 3/8" wide, 14 links per foot. Tensile 34.6 lb., color - black UV stabilized.

**AGF AG1150** - AgLok - 1,000 pcs. • 11.5" strips

**AGF CAG999** - Continuous AgLok • 150' boxes

**AGF CAG500** - Continuous AgLok (bulk) • 500' spool

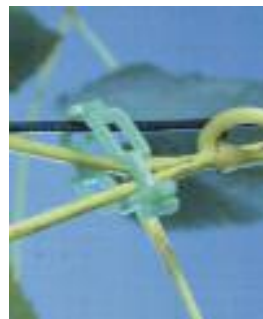

### Green-Tie

11.5" strips. Green color. 36.8 lb. tensile strength. Lower cost than AG1150.

**AGF GT1100-1** - 1,000 pcs.



### Training Devices



### TrellisLok (Strap)

Nut fastener prevents lateral movement of vertical stems. Adjustment on strap to 3 1/2". Removable and reusable. Attached to 10-14 gauge wire.

**AGF TL-0350** - 150/bag



### Continuous TrellisLok (Nut)

Nut fasteners. For use with AgLok for variable diameter.

**AGF TLN200** - 100/bag



### DripLok

Provides long lasting holder from wire to irrigation line. Available in 1/2" and 7/8" sizes.

**AGF DL0500** - up to 1/2" tubing, 1000/bag • 3 lbs.

**AGF DL0875** - 1/2" to 7/8" tubing, 1000/bag • 4 lbs.

### BranchLok

Used for lateral training of trellised branches. Attaches to 12-14 gauge wire. Available in 2 1/2", 3 1/4", 3 3/4" lengths. 1000 in bag.

**AGF BL0250** - 2 1/2" for up to 12 ga. wire • 1.5 lbs.

**AGF BL0325** - 3 1/4" for up to 14 ga. wire only • 1.7 lbs.

**AGF BL0375** - 3 3/4" for up to 12 ga. wire • 2 lbs.

# MAX TAPENER

TIES TAPE WITH ONE SQUEEZE.

SECOND SQUEEZE CUTS TAPE AND STAPLES. TWO SIZES.



**MAX**

Indispensable for growing of grapes, raspberries and some vegetables.

**SAVES TIME! VERY EFFICIENT!**

Small tapener takes 3 1/8" diameter rolls

**MAX 3702 HTB** • 1.25 lbs.

Large tapener takes 4 3/8" diameter rolls

**MAX 3704 HTB-2** • 1.75 lbs.

### Staples & Blades for 3702 and 3704 Tools

**MAX 3708** - Staples 604 E-L (5000/box) - each or case of 10 • 1 oz.

**MAX 3711** - Package of 3 blades • 1 oz.

### Tape for 3702 (small) tool only:



**MAX 3712** - White - 3 1/8" diameter 1/2" wide x .004 thick x 134' long • .25 lb.

**MAX 3714** - Blue - 3 1/8" diameter 1/2" wide x .006 thick x 87' long • .25 lb.

**MAX 3716** - Red - 3 1/8" diameter 1/2" wide x .010 thick x 54' long • .25 lb.

### Tape for 3704 (large) tool only:

**MAX 3718** - Green - 4 3/8" diameter 1/2" wide x .008 thick x 170' long • .25 lb.

**MAX 3720** - Green - 4 3/8" diameter 1/2" wide x .012 thick x 100' long • .25 lb.



### HR-F Stapler

A "hog ring" stapler is used in conjunction with a poly vinyl flax string or tape. This stapler binds together branches to wire for trellis, or vines to trellis when used with the special binding twine MAX Stringline 200.

**MAX 3730** - Stapler tool • .50 lb.

**MAX 3732** - Staples (1000/box) • .35 lb.

**MAX 3736** - Stringline 200, 5mm thick x 660' long roll, available each or case of 20

**MAX 3734** - Blades for HRF (10 blades)



### Clark Grafting Tool

Made from fine alloy steel to make clean splits. Will not tear the bark, or split the stub too far. Designed for cleft and inlaid grafting.

**CLA 1215** - 12"L • 6 oz.

### Nurserymen's Adhesive Tape



**CLA 1260** - 1/2" wide,

180' long roll • .25 lb.

**CLA 3460** - 3/4" wide, 180' long roll



### Budding Strips

Flexi-Band elastic budding strips 1/4" x 6". Sold by the pound.

**FRN BS160** - Approx. 700/lb. • 1 lb.



**Topgrafter** - Tempered steel blades slice wood 1/8" - 1 3/4" without necessary adjustments. Won't bruise wood.

**ZEL TOPGRAFTER**

### Bench Grafting Machine

**BENCH MOUNT ONLY**

Special cut to improve strength, coverage and efficiency of the graft. Strong interlock, identical cuts each plant component. Uses 3/16-3/8" diameter material, maximum is 1/2" diameter.

**CID 1** • 21 lbs.



**Omega Grafting Plier** - Fast, easy, minimal skill needed. Make sharp, precise cuts on stems and branches when grafting.

**ZEL GP1-2**

### Doc Farwell's

### Grafting & Tree Sealer

#### • Grafting Seal

Yellow color absorbs the correct amount of light and heat to promote graft healing. Flexible at low temperatures.



#### • Seal and Heal

Light green colored formula provides a flexible, durable coating for tree wounds.



**Note: Cannot be shipped when there is a danger of freezing. Please plan ahead!**

Size	Grafting Seal	Seal & Heal
5 Gallons	<b>FAR 1000</b>	<b>FAR 1100</b>
1 Gallon	<b>FAR 1001</b>	<b>FAR 1101</b>
1 Quart	<b>FAR 1002</b>	<b>FAR 1102</b>



### Parafilm Nursery Grafting Tape

Waterproof, stretchable, self-sealing tape for grafting and budding of trees, shrubs, plants and flowers. Rolls are 1" wide x 30 yards long.

**COO 4220** • .2 lbs. per roll

### Gashell

1 lb. bar, apply by hand, will not stick to skin. Use in all temperatures. Pliable, noncaustic, product remains unchanged in all temperatures.

**ZEL Gashell**

1 lb. bar or 50 bars to a case



### Trowbridge Grafting Wax

Since 1885. This wax can be used for grafting, budding, and top working on all kinds of fruit, ornamentals and vines. Heat in warm water to work wax.

**CLA 00001** • 1 lb.



### TreeKote™

Tree wound dressing emulsion, can be mixed for cavity filler in a 2 part to 1 part cement to 3 parts sand mix.

**CLA 00212** - 12 oz. aerosol can • 1 lbs.

**CLA 00132** - quart • 2 lbs.

**CLA 00128** - gallon • 8 lbs.

**CLA 00640** - 5 gallon pail • 40 lbs.



PLANTING/GRAFTING

### DEER SOAP

Small deodorant "hotel" soap bars deter deer. Drill 1/4" hole in bar, add string and hang from tree or stake. Leave wrapper in place for longer life of the bar. Available single, package (50 bars), or case (500 bars)



### GIN DEER-SOAP



### Deer Deterrent Twist Tie

Tested in orchards and Christmas tree farms with excellent results!



Apply a minimum of one tie every 3' on tree or bush at the height where the most damage occurs. 8" x 1/4" clear plastic cut ties. Packaged: 1,000/box. **BED 218360-3401**

## BOBBEX™

Deer Repellent and Plant Growth Nutrient



A uniquely original foliar spray

- 2-in-1 repellent and fertilizer that is very offensive to deer
- Can be used on all ornamental shrubs, flowers and around vegetables
- Will not wash off
- Safely disrupts the foraging patterns of deer
- All natural ingredients
- Encourages microbial activity

- BOB B550110** - 1 quart convenient spray  
**BOB B550105** - 1/2 gallon concentrate, will make up to 4.5 gallons of mixture  
**BOB B550160** - 2 1/2 gallon concentrate, (drop ship available)  
**BOB B550115** - 5 gallon concentrate (drop ship available)

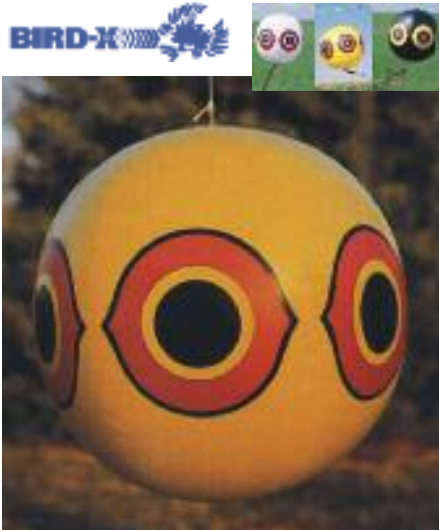

This is the old standard vinyl bird balloon that repels birds by the bizarre design of eyes. Place just above crop and at borders to interfere with flight patterns. 16" diameter.

- BDX SEY Yellow** • 1/2 lb.
- BDX SEW White** • 1/2 lb.
- BDX SEB Black** • 1/2 lb.

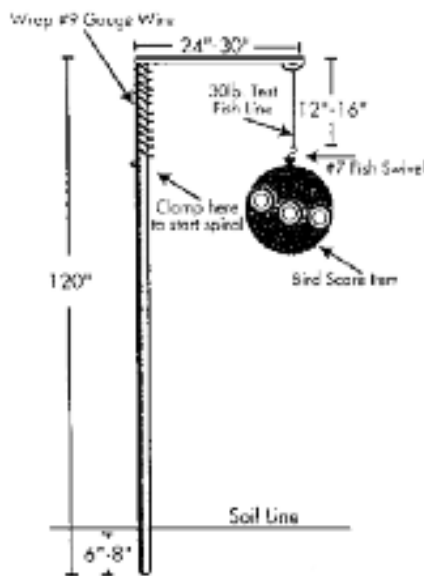

### Suggested installation for Scare Eye Bird Balloons

- Materials needed:
- 10' length of 3/8" diameter steel reinforcement rod (the type used in concrete structures)
  - 6' of 9 ga. wire
  - 18" monofilament fishing line
  - #7 fish swivel
  - Wire cutters, locking-type pliers, work gloves

Note: the 3/8" steel rod is sold in 20' lengths at most building supply stores, but they will usually cut it in half at no charge.

Reprinted from *Fruit Grower*, March 1997



### TERROR-EYES EXTRA LARGE BIRD BALLOON



Balloon with holographic eyes and 24" diameter, heavier vinyl than SE model, equipped with spring bracket. **BDX T-EYES**

## Scare Wyndmill

To the birds, UV light reflecting blades look like birds taking off in flight

- Repels birds in orchards, vineyards, fruit trees and blueberries
- Covers up to one acre
- Used in combination with distress calls
- 36" diameter blades
- Effective on wild turkeys
- 30 day money back guarantee
- Mounts on 1/2" pipe

**JWB - Scare Wyndmill** • 8 lbs.



The Bird Gard units features a combination of bird distress calls and predator calls recorded on a microchip. We stock the standard agricultural chip (chip 1A) featuring the European starling, American robin, house finch, ring-billed gull, common grackle, sharp-shinned hawk, blue jay and red-winged blackbird.

Other available chips cover different species including marine (gulls), crow/ raven, super starling, woodpecker, and a special combination chip. The combo chip (chip 21) adds harassment calls to a distress/predator chip. This combination confuses and moves birds who are not otherwise affected by predator/ distress calls individually. Cedar wax wings, migratory robins and pigeons are an example of these birds.



### Bird Gard Pro

Single speaker unit covers 1.5 acres, 120V AC adapter with 50' cable. Non-replaceable chip.

**BIR 0033-1A** - Standard agricultural unit

Optional:

**BIR B0010** - Battery cable, 12V with clips

**BIR 0010X** - Extension speaker with 100' of cable, disables main speaker



### Bird Gard Pro Plus

Protects up to 3 acres of crop. A more powerful unit with 2 amplifiers, control box, 2 speakers each with 100' of cable, 120V AC adapter with 50' of cable, 12V DC battery cable 10' long with clips.

**BIR 0035-1A** - Bird Gard Pro Plus with standard agricultural chip

### Bird Gard Super Pro

Protects up to 6 acres of crops. Control box with 4 amplifiers, 4 speakers each with 100' of cable 120V AC adapter with 50' of cable, 12V DC battery cable with clips. Also available in a 4 speaker box version.



**BIR 0041-1A** - Bird Gard Super Pro with standard agricultural chip

**NEW**



### Bird Gard Super Pro Wireless

No cables or wires that can get damaged or cut. Each Bird Gard Super Pro Wireless transmitter/ controller broadcasts sounds up to 1,000 feet in any direction. Each wireless 4-speaker/receiver covers up to 6 acres. Add additional speaker/ receiver units for greater coverage. Adjustable volume with random audio cycle patterns so birds never get comfortable. Uses standard user replaceable EPROM recording chip.

**BIR 0045-1A** - Bird Gard Super Pro Wireless w/standard agricultural chip.

Includes One Super Pro Transmit unit, AC power adapter with 50' of cable, 12V battery cable with clips, mounting bracket and hardware. One 4-speaker/ receiver unit with 12V battery cable with clips. Each speaker/receiver unit needs its own 12 volt auto battery.

**BIR 0046R** - Additional 4-speaker/receiver unit with 12V battery cable with clips



## BIRD GARD FEATURES

- The Bird Gard Pro Plus, Super Pro and Super Pro Wireless feature a user replaceable recording chip that can be easily changed. This feature is useful for multiple crops and/or multiple problems.

- Each species distress call randomly changes in frequency and duration creating the illusion that more than one bird of the species is distressed.

- The Bird Gard Super Pro features random speaker sequencing in addition to the frequency modulation, creating the illusion distressed birds are scattered around the orchard or field.

**Caution: Harassment chips make annoying sounds and should be used with caution near residential areas.**

**Call for technical support.**



## Deer Problems? Introducing the Deer Shield Super Pro from Bird Gard!



The NEW DEER SHIELD SUPER PRO electronic deer repelling system is specially designed to broadcast lower frequency sounds to drive away deer using digitally recorded sounds. The unit repels deer by broadcasting audible sounds made by distressed deer. The Deer Shield Super Pro uses multiple random features to prevent habituation. Each Deer Shield Super Pro can protect up to 6 acres, depending on total speaker usage. Each unit includes a generating unit, a replaceable EPROM recording chip and your choice of one, two or four PA-style speakers. Also included are both a power adapter and a 10' battery cable with clips for use with a 12V battery.



### Deer Shield Super Pro Systems

Each speaker protects up to 1.5 acres

**BIR 0053-1/SPK1** - One speaker system

**BIR 0053-1/SPK2** - Two speaker system

**BIR 0054-1/SPK4** - Four speaker system

### Bird Gard Super Pro PA4

The Bird Gard Super Pro PA4 uses the same low frequency technology as the Deer Shield Super Pro. The Super pro PA4 has been used successfully to deter notorious nuisance birds. Each unit comes with one PA4 speaker which protects up to 1.5 acres.

#### Popular Replaceable EPROM Chips

**BIR 675-0158-00** - Canadian Geese

**BIR 657-0181-00** - Wild Turkeys

**BIR 657-0188-00** - Heron/Egret

### BIR 0043-PA4 Bird Gard Super Pro PA4

Includes electronic control unit with one power amplifier and a replaceable EPROM recording chip, one PA-type speaker with 100' of cable, AC power adapter with 50' of cable, 12V battery with clips. Specify chip when ordering.

**BIR C-0100W** - Additional PA4 speaker with 100' cable designed for use with PA4 units only

## BIRD NET

Lightweight premium grade bird net. Black in color, extruded, 2.9 lbs./MSF UV protected with fine grind carbon plus UV inhibitor resin additive. Mesh is 3/4" square and supplied either 14' or 17' wide. All smaller pieces are parts of larger rolls.

All of the following shipped UPS:

<b>WCT 7' x 50'</b>	<b>WCT 17' x 50'</b>
<b>WCT 14' x 50'</b>	<b>WCT 17' x 75'</b>
<b>WCT 14' x 75'</b>	<b>WCT 17' x 100'</b>
<b>WCT 14' x 100'</b>	<b>WCT 17' x 300'</b>
<b>WCT 14' x 300'</b>	<b>WCT 17' x 500'</b>
<b>WCT 14' x 500'</b>	<b>*WCT 28' x 28'</b>
	<b>*WCT 34' x 34'</b>

\* Supplied in 2 pieces.

Complete rolls:

**WCT 14' x 5000'** - 4" OD x 3 1/2 ID  
Core Roll 14' x 5000' • 238 lbs.

**WCT 17' x 5000'** - 8" ID Core Roll

17' x 5000' • 289 lbs.

\* Rolls truck freight only

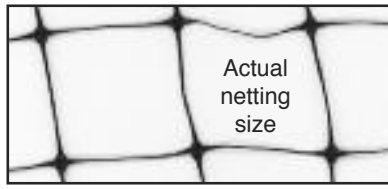

## MYLAR TAPE

## POPULAR

1" x 500' metallized polyester tape, plain tape NO holographic image. Flashes and noise scare birds. Some say silver/red is a more effective tape.

**COO 3550** - 1" x 500' roll, Silver only

**COO 3552** - 1" x 500' roll, Silver/Red

**WARNING: Above tape can conduct electricity. Use properly and safely.**

## BIRD TAPE - PASSIVE REPELLING OF BIRDS IRRITAPE

2" wide x .001" thick x 100' roll of iridescent polyester foil with holographic image which reflects a flash from the sun and metallic noise as it moves in the wind. This danger signal creates an "off limits" zone to birds.



**BDX Tape 100** - 100' Irritape kit

1 roll tape, 8 supports

**BDX Tape 500** - 500' Irritape kit

1 roll tape, 36 supports

## NEW



## 3-D Coyote

Installs easily ... place it anywhere you can bury a stake.

This life-size menacing predator replica strikes instinctual fear into the hearts of geese, other birds and small animals. The "3-D" structure makes the decoy visible from every angle, making it very effective.

**BDX 3D-COYOTE**



*Moving tail accurately emulates what birds fear in a predator.*

## THE ZON

### EL08 ELECTRONIC PROPANE CANNON



#### Virtually no moving parts

The only moving part on the EL08 is the valve that controls the gas flow. No more broken springs to replace, no worn out diaphragms - less time in the shop means more time protecting your investment! Operates on 12V battery. Battery not included.

#### Multiple blast capability

The EL08 with electronic timer can produce 1, 2, 3 or 4 blast series with approximately 5 seconds between blasts.

#### Enhanced 24-hour timer

There's no need to purchase a separate on/off timer. The EL08 includes a 24-hr. timer that can be programmed with multiple on/off periods (compare to just 1 on/off period with standard ZON timer).

#### Programmable configuration

Blast intervals can be set between 1 and 60 minutes. Electronic timer provides 3 different random interval settings (selects a different time interval after each series of blasts).

#### ZON EL08

#### ZON 4MT08 CONVERSION KIT



Get all the features of the EL08 without buying an all new cannon!

With the ZON 4MT08 Conversion Kit you can convert your Mk4, Mk2, or any other propane cannon to a semi-electronic cannon.

#### ZON 4MT08

#### ZON EL08 TRIPOD

To be used with ZON EL08 cannon.

#### ZON EL08-Tripod

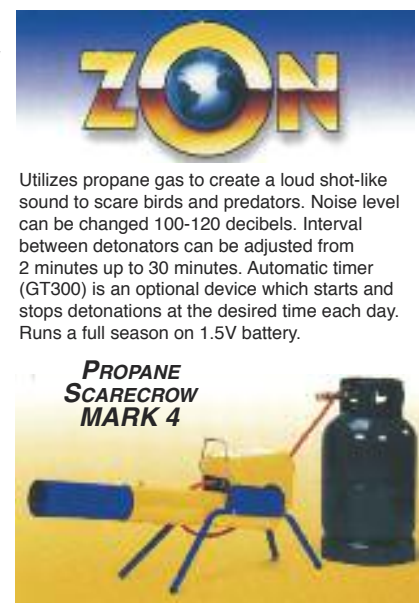

Utilizes propane gas to create a loud shot-like sound to scare birds and predators. Noise level can be changed 100-120 decibels. Interval between detonators can be adjusted from 2 minutes up to 30 minutes. Automatic timer (GT300) is an optional device which starts and stops detonations at the desired time each day. Runs a full season on 1.5V battery.

#### PROPANE SCARECROW MARK 4



#### MARK 4

Standard unit, 20 lb. tank, delivers 17,000 explosions (tank not included) Option: Zon Mark 4 Tripod, GT300 timer. Covers 1-5 acres depending on shape and topography of the field.

**ZON 05ZG4** - gun • 16 lbs.

#### MARK 4 TRIPOD

Changes direction each blast, adjustable tripod legs for uneven ground, elevates the ZON unit 4' and can be extended to 6' or 7'5". Provides 360° coverage. Each detonation pivots the ZON gun 50-70° in a full circle.

#### TRIPOD ONLY.

**ZON OTA4** • 13 lbs.



#### AUTOMATIC TIMER

Automatically starts and stops operation of gun each day at any desired time. Enclosed in weather and dust protective case, high quality movement runs a full season on one penlight battery.

**ZON GT-300**





# Smart Net Systems Overhead Crop Protection Netting

## Complete Enclosure Systems for Apples, Cherries, Grapes and Berries.

OESCO is pleased to be the exclusive distributor of **Smart Net Systems** for the lower 48 states. Smart Net Systems of British Columbia is the importer of the finest polyethylene netting products available, including bird netting for crop protection. Smart Net Systems overhead crop protection netting is a UV treated, tied polyethylene netting - 1300 denier thickness by 7/8" square with heavy 12 ply meshes on each edge. The netting comes with a cord threaded through each edge to facilitate threading onto support wires.

Protects your crop while harvesting. The crop is not exposed to predators; your netting remains in place while harvesting. Just lift the panels at the end of the row to allow access for personnel and equipment.

Because the netting is suspended above the crop - not simply draped over it - birds cannot reach through the netting to cause damage. The tautly strung 7/8" mesh netting effectively repels birds without entangling them.

Netting is stored on the trellis. Once installed, less labor is required to spread or remove netting, on a yearly basis; just slide the netting to the end of the row and wrap it for the winter.

Properly installed and managed, overhead systems will last ten years or more.

No expensive machinery needed to install or remove netting.

Available Sizes:

- 20 ft. x 337 ft.
- 32 ft. x 337 ft.
- 40 ft. x 337 ft.
- 50 ft. x 337 ft.

- 20 ft. x 531 ft.
- 32 ft. x 531 ft.
- 40 ft. x 531 ft.
- 50 ft. x 531 ft.

13 ft. x 337 ft. (side curtain netting)

**Call us for assistance in designing a package to meet your specific crop protection needs. We will provide you with technical details regarding infrastructure and installation.**

For additional photos and information on Smart Net Systems, visit <http://www.smart-net-systems.com>.



*"The Smart Net system is so good, I'll never use anything else. The netting material is easy to handle and conforms to different sizes and shapes."*

Mo Tougas  
Tougas Family Farms

SMART NET

# Wells & Wade Harvest Equipment



We have handled Wells & Wade harvest supplies for many years. Presently they manufacture a poly 3/4 bu. bucket and two models of picking bags only.

## PLASTIC PICKING BUCKETS

**WEL 7P104** - jumbo bucket - foam liner, cordura bottom - skirt  
3/4 bu. cap. • 4.8 lbs.

**WEL 7P105** - jumbo bucket - foam liner, padded cordura solid bottom - skirt  
3/4 bu. cap. • 5.5 lbs.

## PICKING BAG - NO SUPPORTING PLASTIC SIDES

**WEL 73187** - #80S - picking bag, cordura material -  
1 bu. cap., 30" deep • 2.6 lbs. (not pictured)

**WEL 73396** - #80SL - long picking bag, cordura  
material - 1.3 bu. cap., 36" deep • 2.8 lbs.



WEL 73609

## SPARE PARTS AVAILABLE

### Bottoms:

- WEL 73609** - #1 cordura bucket bottom, 1/2 bu.
- WEL 73611** - #1 cordura, padded bucket bottom, 1/2 bu.
- WEL 73724** - jumbo cordura bucket bottom, 3/4 bu.
- WEL 73725** - jumbo cordura, padded bucket bottom, 3/4 bu.

### Straps:

**FRI S108** - 2" wide x 108" long

### Harness:

**WEL 73486** • 12 oz.

### Padded Harness:

Heavy duty padded comfort harness for bag or bucket.  
**WEL 73488** • 12 oz.

All parts available for both  
old & new style buckets.



WEL 73486  
Harness



WEL 73488  
Padded  
Harness

PICKING BUCKETS/POLE PICKERS



METAL BUCKETS

## HANDY FRUIT PICKING EQUIPMENT

Metal picking buckets available with Cordura fabric skirts (bottoms).  
1/2 bu. model may be purchased unlined, with foam liner, or with  
snap-in foam liner. 3/4 bu. available only with foam liner.

**FRU 012201** - 1/2 Bu. Unlined

**FRU 013201** - 1/2 Bu. With foam liner

**FRU 014201** - 1/2 Bu. With snap-in liner

**FRU 013301** - 3/4 Bu. With foam liner

## PARTS FOR ABOVE BUCKETS

**FRU 055220** - 1/2 Bu. Cordura bottom (skirt)

**FRU 055240** - 1/2 Bu. Padded Cordura bottom (skirt)

**FRU 055320** - 3/4 Bu. Cordura bottom (skirt)

**FRU 0626L** - 1/2 Bu. Foam liner, non-adhesive

**FRU 0636L** - 3/4 Bu. Foam liner, non-adhesive

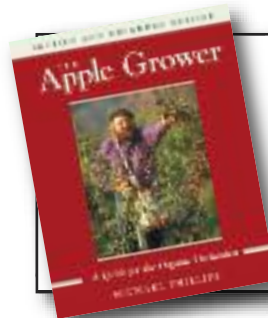

## The Apple Grower - A Guide For The Organic Orchardist

by Michael Phillips

A definitive guide to growing  
apples wisely, naturally, and  
with gentler impact on the earth.

**BOK 8911**

## FRUIT PICKER

Easy and safer to pick hard to reach fruit  
without a ladder. Picks apples, oranges,  
peaches, apricots, plums, etc. Lightweight  
and easy to use. Supplied with a 2 section  
8' wood pole. Assembly required.

**BON 9164** - with pole • 3.3 lbs.

Check price list for  
volume discounts.



## PICKING HEAD

New design polyethylene head,  
5" high x 5 1/2" in diameter supplied  
with an 8" deep bag attached. This  
picking head may be used by hand or  
with a wood pole (see below) or attach  
your own pole. Supplied without pole.

**ORC PPH** - complete • .5 lb.

**ORC PPHB** - Replacement bag • 4 oz.



## WOOD POLE FOR FRUIT PICKER HEAD

**ORC FIVE-FOOT** - one piece pole • 1 lb.

Additional wood poles, available in assorted sizes,  
from Peavey Manufacturing



If you can pick it, a FRIEND can hold it.

OESCO has been selling this product for decades. We liked it so much we bought the company!

### Still FRIEND - Still Made in the U.S.A. Only from OESCO



#### IMPROVED SPECIAL BUCKET

Heavy duty, reliable, strong, with replacement parts. Solid, high density polyethylene bucket with a metal frame and a closed cell foam liner. Buckle held skirt is front released.

- FRI IS2 - 1/2 bu. - yellow skirt • 5.7 lbs.
- FRI IS3 - 3/4 bu. - red skirt • 6.2 lbs.
- FRI IS4 - 1 bu. - blue skirt • 6.7 lbs.
- FRI IS2SB - 1/2 bu. - yellow padded bottom • 6.3 lbs.
- FRI IS3SB - 3/4 bu. - red padded bottom • 6.8 lbs.
- FRI IS4SB - 1 bu. - blue padded bottom • 7.3 lbs.



#### DELUXE SPECIAL BUCKET

Same as above but has a rope-held skirt which is side released.

- FRI DS2 - 1/2 bu. - yellow skirt • 5.7 lbs.
- FRI DS3 - 3/4 bu. - red skirt • 6.2 lbs.
- FRI DS4 - 1 bu. - blue skirt • 6.7 lbs.
- FRI DS2SB - 1/2 bu. - yellow padded bottom • 6.3 lbs.
- FRI DS3SB - 3/4 bu. - red padded bottom • 6.8 lbs.
- FRI DS4SB - 1 bu. - blue padded bottom • 7.3 lbs.



#### IMPROVED APPEACH BUCKET

LIGHTWEIGHT!

Lightweight, durable with a steel frame. The welded steel frame supports a Cordura fabric body and skirt. Buckle held, front release skirt. Non-replaceable parts except straps.

- FRI I2 - 1/2 bu. - yellow skirt • 3.1 lbs.
- FRI I3 - 3/4 bu. - red skirt • 3.25 lbs.
- FRI I4 - 1 bu. - blue skirt • 3.5 lbs.



#### DELUXE APPEACH BUCKET

LIGHTWEIGHT!

Same as above Appeach but has rope held skirt which is side released.

- FRI D2 - 1/2 bu. - yellow skirt • 3.1 lbs.
- FRI D3 - 3/4 bu. - red skirt • 3.25 lbs.
- FRI D4 - 1 bu. - blue skirt • 3.5 lbs.

#### ORCHARD KRAFT PICKING BAG

LIGHTWEIGHT! NO SUPPORT! ADJUSTABLE CAPACITY!

Lightweight and versatile picking bag which is Cordura fabric constructed with rope held bottom adjusts to hold 7/8 Bu. of fruit or produce. Ropes hook at sides.

- FRI OK - red fabric • 2 lbs.



#### ORCHARD KRAFT UTILITY BAG

RECOMMENDED TO USE FOR PEACHES

Lightweight and adjustable capacity. Manufactured from Cordura fabric (snap held bottom). Adjusts to hold up to 3/4 Bu. of fruit or produce. Includes waist strap.

- FRI UB - yellow fabric • 1.75 lbs.



#### Parts available for



2"x108" straps for all bags and buckets we sell  
FRI S108



Side Assembly

w/ hook • FRI SD

1 1/2" Buckle Set • FRI B5

Foam Liner

3/4 bu. • FRI 5011

1 bu. • FRI 5010

For the Improved Special (Buckle)

1/2 bu. Yellow • FRI IS2S

3/4 bu. Red • FRI IS3S

1 bu. Blue • FRI IS4S

Solid padded available

For the Deluxe Special (Rope held)

1/2 bu. Yellow • FRI DS2S

3/4 bu. Red • FRI DS3S

1 bu. Blue • FRI DS4S

Solid padded available

Note: Skirts available by special order only for loop/lever models, 1" buckle and other model buckets made by FRIEND.

#### Fruit Bucket Strap for most buckets

FRI S108 - 2" x 108" strap for bucket • .25 lb.



FRI S108

#### Comfort Pads

FRI HB-194C - 19" comfort pad for strap

FRI HB-284C - 28" comfort pad for strap



NEW

Comfort pads

#### Peach Basket Straps

FRI SHLS - 2" webbing, large snaplock • .25 lb.

FRI SHS - 2" webbing, small snaplock • .25 lb.

FRI SHH - 2" webbing, with hooks • .25 lb.

FRI SLS - 1 1/2" webbing, small snaplock • .25 lb.

FRI SLH - 1 1/2" webbing, with hooks • .25 lb.



FRI SLH



FRI SHS

#### Harnesses

Slip lock buckle adjusts to shoulders & size easily.

FRI HHLS - 2" harness, large snaplock hooks

FRI HHS - 2" harness, small snaplock hooks

FRI HHH - 2" harness, with hooks

FRI HLS - 1 1/2" harness, small snaplock hooks

FRI HLH - 1 1/2" harness, with hooks • .5 lb. ea.

FRI HB194C - Comfort pads shown on harness



NEW

Comfort pads

Large snaplock



Small snaplock



Hook



PICKING BUCKETS/BAGS/HARNESSES

## HUBBARD BLUEBERRY RAKES



**NEW**

Hubbard Rakes are a fine toothed, totally balanced rake designed not to break while raking for wild blueberries. (Not designed for use with cultivated blueberries). Available in a 12" or 15 1/2" size.

**HBB 40T** - 12" rake  
**HBB 50T** - 15 1/2" rake

### HAND REFRACTOMETER

Accurate, fast determination of Brix in grapes, apples, and other fruits. One drop of sample required. Temperature compensated measurements are read directly and instantly. Scale 0°-30° in 0.2° divisions.

**VWR 55680-302**

Other models available by special order.



### DIAL FRUIT PRESSURE TESTER

The Effegi dial pressure tester is a small tester which can be used in the field as well as in the laboratory. Supplied in small case with two tips for testing apple, pear, and stone fruits.

**WAG FT30** • .5 lb.



### LOOP FRUIT SIZER

Poly handled sizer with metal sizing loop 0.8"-4" or 20-100 millimeters.

**WIR LS4** • 4 oz.

### FRUIT SIZING PLATE

7 3/4"L x 6"W x 3/16" thick. Aluminum alloy cast plate with 2", 2 1/4", 2 1/2", 2 3/4" and 3" holes.

**ORC PH-AS5** • .5 lb.



### FRUIT SIZING RINGS

4" x 5" x 7/8" thick apple sizing rings; set of 17 sizes, range of 2 1/8" - 3 5/8". Poly plate with cut out circles.

**WIR PSR** • .2 lb.



## Tripod (3 leg) Wood Ladders

Traditional, wood, 3 leg fruit harvest ladders. Sturdy, self supporting design. Excellent for smaller fruit trees, bushes, other agricultural crops.

- Rails are air dried big tooth aspen
- Rungs Only, No Steps, are ash hardwood
- Third Leg is 1 5/16"x2" big tooth aspen
- Wood treated and protected for moisture and UV
- Pointed top approximately 3' above last usable rung
- Weighs 3 lbs. per foot

Stocked sizes

**BAL W08-TRI** - 8' Length

**BAL W09-TRI** - 9' Length

**BAL W10-TRI** - 10' Length

(Example: 8 rungs and 10' 7-1/2" OAL on W10 TRI)

Special Order Only

**BAL W06-TRI** - 6' Total Length

**BAL W07-TRI** - 7' Total Length



W08TRI pictured



## Traditional Wood Ladders

Traditional wood fruit harvest ladders are manufactured in Maine in even lengths 10' to 22' long. Rungs are spaced 1 foot apart and the rails are available in an open top or closed (pointed) top design.

- Rails are air dried big tooth aspen wood
- Rungs are air dried ash hardwood
- Wood is treated and protected for moisture and UV
- Ladders weigh approximately 2 lbs./ft.

Stocked sizes:

Closed (pointed)Top	Open Top
<b>BAL W10-PT</b> - 10 feet	<b>BAL W10-OT</b> - 10 feet
<b>BAL W12-PT</b> - 12 feet	<b>BAL W12-OT</b> - 12 feet
<b>BAL W14-PT</b> - 14 feet	<b>BAL W14-OT</b> - 14 feet
<b>BAL W16-PT</b> - 16 feet	<b>BAL W16-OT</b> - 16 feet
<b>BAL W18-PT</b> - 18 feet	<b>BAL W18-OT</b> - 18 feet
<b>BAL W20-PT</b> - 20 feet	<b>BAL W20-OT</b> - 20 feet



12' closed top W12-PT 12' open top W12-OT

Special orders: 10' and 22' available special order only. All ladders truck delivery or LTL freight only.

## ALUMINUM FRUIT HARVEST LADDERS

**METALLIC LADDER MFG. CORP.**  
MANUFACTURES OUR METAL LADDERS

Aluminum boxed girder siderails, aluminum tube rungs. Available open top 10' - 24' every 2' or closed top 11' - 25' every 2'.

**MANY SIZES IN STOCK - OTHERS SIZES BY SPECIAL ORDER - CALL FOR AVAILABILITY**



Shipped by our truck or LTL Freight only

**CAUTION! Ladders can conduct electricity and be dangerous to your health and safety. Use care when ladder is placed near energized electrical lines or equipment.**

Other ladders are available. Please contact us for more information.

# Orchard LADDERS

## PRUNING AND HARVEST AGRICULTURAL TRIPOD LADDERS

This ladder works well on uneven ground.  
For use in outdoor applications only.

These **heavy duty, high quality, lightweight, sturdy** agricultural ladders are manufactured in Washington State.

**LADDER SIZES AVAILABLE**  
4', 6', 7', 8', 10',  
12', 14', 16'

Check these features!



Heavy duty top bracket/pivot

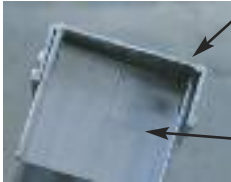

Bottom of leg  
3 inch extra strong side rail  
Pad for soft ground



Heavy duty bottom step brace helps eliminate most common equipment caused damage



3 inch wide steps reinforced for greater strength  
Safety ribs in

Ask about the adjustable leg option!

**CAUTION!** Ladders can conduct electricity and be dangerous to your health and safety. Use care when ladder is near energized electrical lines or equipment.

This 3 leg, tripod style works very well on soft or uneven ground. Very stable. For use outdoors only.

Features include:

- All aluminum construction
- Extra strong extruded aluminum side rail
- Solid aircraft aluminum rivets throughout
- Full 3" wide step with non-skid ribs
- Sturdy aluminum 3rd leg complete with wood dowel on ground end
- Heavy duty top bracket/pivot
- Weight approximately 2.5 lbs./foot of length
- Repair parts available

Truck delivery/ LTL truck freight only

	HEIGHT	BASE WIDTH
STO 1104	- 4 feet	31 inches
STO 1106	- 6 feet	39 inches
STO 1107	- 7 feet	44 inches
STO 1108	- 8 feet	41 inches
STO 1110	-10 feet	45 inches
STO 1112	-12 feet	52 inches
STO 1114	-14 feet	55 inches
STO 1116	-16 feet	63 inches



4' 6' 7' 8' 10' 12' 14' 16'



LADDERS

## 6" HDPE APPLE GRINDER

The perfect complement to the Lancman water operated fruit presses. Grinds a bushel of apples in 90 seconds.



- 6" HDPE (High-Density Polyethylene) drum with replaceable carbide teeth
- 115V, 1/2 HP TE (totally enclosed) motor, 1725 RPM, fan cooled with on/off switch
- Stainless steel grater box, concave and chute
- Predrilled for easy mounting
- Includes stand

### ORC 6-HDPE

#### Apple Pressing



Grind



Fill



Press



Open



Empty

## OESCO ELEVATOR-GRINDER designed to use with Lancman Presses

**NEW**



This new elevator-grinder combination is designed to be used with Lancman presses. Double your productivity with two presses: as one is being filled, the other can be pressing. The hopper is filled by dumping boxes of apples into it or can be used with a brusher washer or conveyor for automatic feed.

- 6" HDPE grinder drum with replaceable carbide teeth
- 220V, 1 HP TE (totally enclosed) motor, single phase
- Requires electrical wiring
- On-off switch not included

### ORC 6-EASY-FEED

**WATER OPERATED PRESSES**

We import these presses from Europe. They are easy to use and very efficient. Pour ground fruit into the press, close the cover and connect the press to your garden hose.

Using household water pressure the rubber bladder expands outward, pressing the fruit evenly against the inner surface of the basket. The pressure gauge allows for accurate monitoring during pressing.



Lancman press in tilted position



**Pressing Bags for Lancman Presses**

- GOM 5416** - for X80 press
- GOM 5415** - for X120 press
- GOM 5414** - for X170 press
- GOM 5750** - for X250 press



**Cider Transfer Pump**

- 3/4" FPT inlet, 1/2" MPT outlet
  - 115V, 1/12 HP pump
  - 10 GPM
  - Magnetic drive
- ORC 2P038**



**Submersible Cider Pump**

- 3/4" FPT inlet, 1/2" MPT outlet
  - 115V, 1/12 HP pump
  - 10 GPM
  - Nylon impeller
- ORC 1P322**

**CIDER EQUIPMENT CLEANER**

(Oakite)

Chlorinated, alkaline detergent cleans, sanitizes and deodorizes cider processing and food processing equipment. Works for CIP or hand brush operations. Cleaner/sanitizer. It is a strong oxidizing agent.

**ORC C30** - sold by the pound

Approved for use by USDA and FDA.



- Basic equipment:**
- 2 fixed + 2 swivel wheels for transport
  - Pressing bag
  - PVC cover for press



Tilts 90° for easy cleaning. Tree fruit must be ground and grapes crushed and de-stemmed prior to pressing. Press is lightweight, made of stainless steel and works on water pressure up to 40 PSI.

**Press is NOT designed for air pressure**

MODEL	VSPI-X80	VSPI-X120	VSPI-X170	VSPI-X250
<b>Basket Capacity Bu (ltr)</b>	4.5 (80)	6.7 (120)	9.5 (170)	14 (250)
<b>Press Time apples (grapes)</b>	20 (40)	20 (40)	20 (50)	20 (50)
<b>Estimated Yield apples*</b>	22.5 GPH	34 GPH	47.5 GPH	65 GPH
<b>Dimensions</b>	24"x24"x47"	32"x32"x51"	35"x35"x53"	35"x35"x61"
<b>Weight</b>	80 lbs.	120 lbs.	160 lbs.	242 lbs.
<b>Max. Pressure PSI</b>	40	40	36	36

\* Based on 2 pressings per hour with yield of 2.5 gallons/bushel of apples

**Grape Pressing**



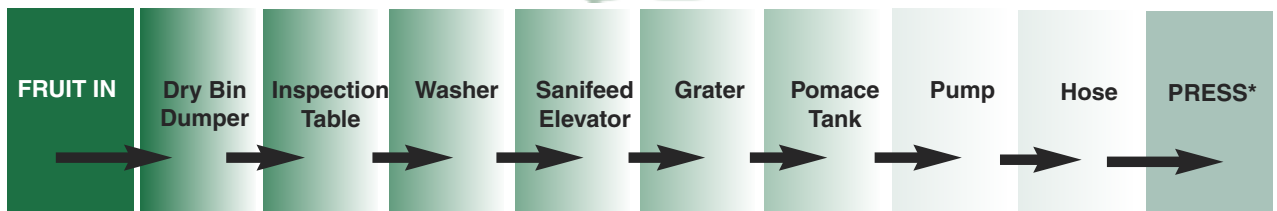

**GRATER - with stainless steel drum, stainless frame**

\* At press - build cheese with rack, cloth, cheese form



The grater prepares the fruit for pressing. The ground up fruit is called pomace. Quality, clean, mature fruit is grated (sliced) by a stainless steel drum fitted with high carbon steel knives which pass close to a curved stainless

plate (concave). A stainless steel grater box is supplied with a grater. **Not supplied with this grater are:** pulleys, belts, motor and pomace tank (Check chart for motor size needed)

**Replaceable components:** The drum, concaves, bearings, concave shaft, stainless steel springs, nuts & washers.

Three models of grater manufactured:  
**ORC 7-100 • ORC 8-100 • ORC 10-100**

Model	ORC 7-100	ORC 8-100	ORC 10-100
<b>Estimated Capacity</b>	120 bu/hr	250 bu/hr	440 bu/hr
<b>Grater Speed</b>	3400 RPM	3000 RPM	3000 RPM
<b>Number of Knives</b>	12	20	20
<b>HP Motor (Electric)</b>	1	5	5
<b>Drum Diameter</b>	6"	8 1/2"	8 1/2"
<b>Drum Length</b>	7"	7 1/2"	10"
<b>Weight</b>	60 lbs.	100 lbs.	130 lbs.

*Note: Drum service supplied. We rebuild the drum and ship rebuilt and sharpened drums to replace worn, broken or dull knives.*

**All units quoted at time of manufacture**

**Sanifeed Unit/System**

The Sanifeed unit contains the grater, grater box, elevator box, pomace tank, pomace pump and pomace hose. The grater motor and pomace pump motor are supplied with the unit. The elevator is optional, however, you must have some way to feed the fruit to the grater. The grater tilts 90 degrees for cleaning the pomace tank.

**POMACE TANK:** The pomace from the grater drops into the pomace tank under the grater. The pomace pump moves the pomace from the Sanifeed through the pomace hose to the press.

**POMACE PUMP:** The stainless steel Liverani pomace pump can be completely disassembled for cleaning, maintenance and repair. It is easily removed from the Sanifeed for bench work or replacement.

**MOTORS:** Two electric motors are supplied with the Sanifeed. The grater motor and the pomace pump motor. A pomace pump reversing switch is supplied with moisture resistant cable. Single or three phase motors are available. All units quoted. Manufactured in Conway, MA, USA. Switch provided for elevator motor control. Switch is float activated.



Model Number/Specs	ORC 28D-150	ORC 32D-150	ORC 36D-150
<b>For Press</b>	ORC22D & ORC28D	ORC 32D	ORC 36D
<b>Hopper Capacity</b>	3150 cu. in.	4770 cu. in.	4770 cu. in.
<b>Grater</b>	ORC 8-100	ORC 10-100	ORC 10-100
<b>Pump Size</b>	Liverani pumping unit sized to press		
<b>Height w/Elevator</b>	70"	85"	85"
<b>Width</b>	28"	28"	36"
<b>Length</b>	40"	40"	40"
<b>Length w/Elevator</b>	80"	86"	108"
<b>Motor size</b>	3, 5 HP	3, 5 HP	5, 7 1/2 HP
<b>Weight</b>	800 lbs.	950 lbs.	1000 lbs.

Other models available by special order

**Elevator**

Stainless steel trough with nitrile belting. Fruit pegs on belt. 1/2 HP 120 V motor supplied. Normally wired to motor control switch on Sanifeed.

Model # Specs	ORC 28D-160	ORC 32D-160	ORC 36D-160
<b>For Press</b>	ORC 22D ORC 28D	ORC32D	ORC36D

Other models available by special order



Manufactured in Conway, MA - U.S.A.

**Features:**

- Stainless steel and steel construction
- Removable trays and troughs for easier cleaning
- Movable rack guides
- Roll cars to center of press and back to load area
- Juice always drains to trough
- Lower press plate has conductor for juice
- OESCO manufactured hydraulic cylinder

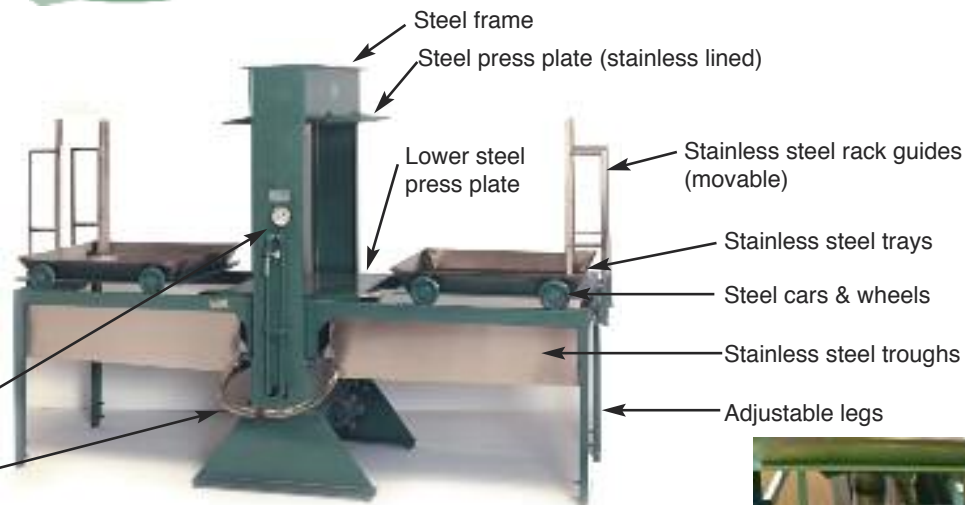

Hydraulic control valve

Hose to transfer pump

Steel frame

Steel press plate (stainless lined)

Lower steel press plate

Stainless steel rack guides (movable)

Stainless steel trays

Steel cars & wheels

Stainless steel troughs

Adjustable legs

**Our vertical rack and cloth hydraulic press**

**Features:** All presses sized by press plate size (22" = 22"x22")  
**Sizes:** 22", 28", 32", 36" available (see chart) standard order.  
 42" and other sizes special order only. 22" and 28" use ORC 28D-150 Sanifeed, 32" uses ORC 32D-150 Sanifeed and 36" uses ORC 36D-150 Sanifeed

**Hydraulics:** Special designed hydraulic pump/reservoir package. Adjustable pressure and boost cycle.  
**Note:** 36" and larger presses have a tie rod frame.



Simplex hydraulic pump/reservoir



Pictured: our ORC-36D Rack & Cloth Press

Size	22"	28"	32"	36"	42"
Model Number	ORC22D	ORC28D	ORC32D	ORC36D	ORC42D
Capacity (GPH)*	80+	100+	150+	350+	700+
Bushel of fruit per stack	7-8	12-15	17-20	20-25	50-65
Average layers/car	10	12	14	17	24
Racks supplied	22 - 22"	26 - 28"	30 - 32"	36 - 36"	50 - 42"
Cloths supplied	20 - 40"x40"	24 - 50"x50"	28 - 60"x60"	34 - 66"x66"	48 - 72"x72"

All electrical controls, switches, installation and wiring are customer provided  
 \* Based on 3 pressings per hour



**Dayton Centrifugal Pumps**

Single phase 1/2HP motor, stainless steel impeller and housing, chemical resistant for use with nonflammable and nonabrasive liquids.  
 Inlet 3/4", outlet 3/4"  
**ORC 4JMV3**

Press only	22	28	32	36	42
Length	96"	115"	120"	155"	175"
Width	46"	56"	63"	63"	76"
Height	96"	96"	96"	96"	96"
Hydraulic Motor	Self contained in Simplex pump unit				
Shipping Wt.	1,900 lbs.	2,800 lbs.	3,600 lbs.	6,500 lbs.	12,000 lbs.

RACK AND CLOTH

OESCO, Inc. (Orchard Equipment and Supply Co.) has been supplying cider presses since 1954. The present design is based on The Original Palmer Bros. Press manufactured until 1950 in Cos Cob, Connecticut.

The vertical rack and cloth hydraulic press utilizes polypropylene cloths and polyethylene racks to produce a high quality juice product.

Presses are manufactured in our shop in Conway, Massachusetts

All presses are quoted at time of manufacture. Manufactured in Conway, MA USA

**Lower Cost  
For Smaller  
Operations**

Only from OESCO, Inc.

**PROVEN RELIABILITY  
FDA APPROVED CIDER PROCESSOR  
PROCESSES 25 GPH**

**NEW**

## SIMPLE ... FAST... EASY

### Automatic Processing ...

Attach in and outflow hoses and flip the switch

### Automatic Cleaning ...

Cleans in less than 1/2 hour after use

- **Low Power Consumption ...**  
Model uses 120 VAC, 1000 Watts & include GFI protection
- **Stainless Steel Cabinet**
- **Lightweight ...** Weighs only 125 lbs.
- **Compact ...** 20"X13"X24"
- **Effective ...**  
Meets FDA requirements for elimination of E. Coli bacteria.  
Controls cryptosporidium and salmonella.
- **Meets 21 CFR 179.39 requirements**



Front



Back

### FLUID SYSTEMS

CiderSure Mini processes 25 GPH.  
Inlet and outlet are 1/2" hose barb.

### CONTROLS

Computer controlled  
Fully automatic push button operation  
Clean and process cycles  
Automatically detects:  
Lamp failure  
Pump failure  
Sensor failure  
Low supply tank level

Unit stops when there is a detection of any fault preventing continued flow of raw cider.



Control Detail

### LAMPS

Ten germicidal Ultra Violet lamps.

### CLEANING

Meets requirements for CIP standards  
Automatic internal cleaning cycle  
Exterior can be hosed down

### MODEL AVAILABLE

**FPE 2500** 25 GPH - unfiltered juice

**WARRANTY: One year on all parts and labor.**

## UV Setup Example

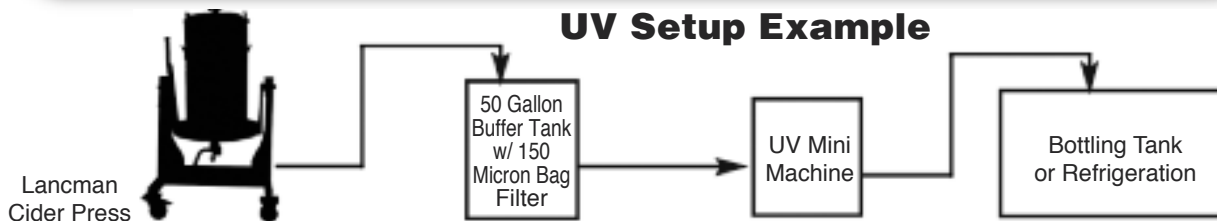

**Buffer Tank needed between press and UV Mini Machine - Reason: UV machine needs consistent flow. Press has periods of high and low flow. The buffer tank provides a place to even out ebb and flow.**

# CiderSure

## SIMPLE .... FAST .... EASY ....

**Automatic Processing** ... Attach in and outflow hoses and flip the switch

**Automatic Cleaning** ... Cleans in less than 1/2 hour after use

### Only from OESCO, Inc.

**TWELVE YEARS OF PROVEN RELIABILITY -  
FDA APPROVED CIDER PROCESSOR**



- **Low Power Consumption** ... All models use 120 VAC, 1000 Watts & include GFI protection
- **Stainless Steel Cabinet**
- **Lightweight** ... Weighs only 150 lbs.
- **Compact** ... 24"X24"X45"
- **Effective** ... Meets FDA requirements for elimination of E. Coli bacteria. Controls cryptosporidium and salmonella.
- **Meets 21 CFR 179.39 requirements**

#### FLUID SYSTEMS

CiderSure has three models that process 100 to 300 GPH. All contact materials are 304 Stainless, Quartz or Food Grade Tubing. Inlet is 1" camlock, outlet is 3/4" camlock.

#### CONTROLS

Computer controlled  
Fully automatic push button operation  
Clean and process cycles  
Automatically detects:  
Lamp failure, pump failure,  
sensor failure and low supply tank level  
Unit stops when there is a detection of any fault preventing continued flow of raw cider.



*In & Out Flow Connectors*

#### LAMPS

Eight germicidal Ultra Violet lamps.

#### CLEANING

Meets requirements for CIP standards  
Automatic internal cleaning cycle

#### MODELS AVAILABLE

**FPE 3500** – 100 GPH – unfiltered juice

**FPE 3500B** – 160-200 GPH – unfiltered juice

**FPE 5500** – 250-300 GPH – unfiltered juice

**WARRANTY: One year on all parts and labor.**

Back

Front



Pump      Process tube  
UV sensors



Motor controller      Ballasts      PLC computer



*Control panel detail*

#### Maple Syrup Producers Manual - 2nd Edition

A guide with a practical perspective and technical accuracy on how to produce pure maple syrup.  
**BOK 856**

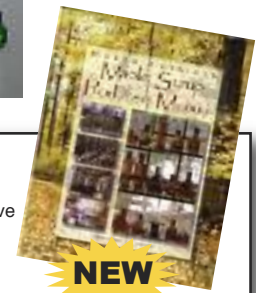

**NEW**

## SAP STEADY UV MAPLE SAP STERILIZER

**STOP LOSING PROFIT TO BACTERIA**



From the same manufacturer as CiderSure  
**Proven Results • Steady Profits**

**Produce MORE Grade A product!**

**Field Tested, Proven and ONLY at OESCO!**

- Exposes thin layer of sap to the UV light, allowing for total kill of all bacteria, yeast and mold present at the time of treatment
  - Uses 6 high intensity germicidal UV lamps inside a crystal tube
  - Mounts on sugarhouse wall
  - Uses standard 120V outlet
  - 30 GPM flow is higher than any other UV unit
  - 3/4" inlet/outlet can be wired to turn on and off with your vacuum
- FPE 8001**

**Kill bacteria in maple sap • Make more syrup!**

**The only UV machine made specifically for maple production!**



NOW  
AVAILABLE!  
**The Sap  
Steady  
JUNIOR**

12 gallons/minute  
Wall mounted  
and compact!  
**FPE 8010**

**NEW**

UV CIDER and SAP PROCESSORS



Manufactured in Conway, MA - U.S.A.

### BRUSHER WASHER

Cleans Apples & Vegetables • Operates Wet or Dry • 18", 24", 30" and 36" widths available  
All 42" long • Specialty Brushes Available • Can be operated up to 10° angle



Water control valve

Gear motor

All welded steel construction with galvanized sheet metal

9 rows of brushes

Adjustable legs

Water drain

Brush detail

• Rotating brushes so every other brush is the same speed. 9 rows of brushes, gear and chain drive. Good cleaning of windfall fruit or field vegetables. Entire unit may be elevated 10° and still transfer product. Can be run dry for polishing fruit.

• Machine sits against rotary table, conveyor, or hopper to remove fruit. Feed from a belt or roller inspection table.

• Overall length 42"

#### Options:

- High pressure manifold
- Dump chute for bushel boxes
- Closed drain pan with threaded fitting.

WE WILL CUSTOM MANUFACTURE TO YOUR SPECIFICATIONS

Cat. No.	Brush Width	Capacity	Press size
ORC 18-300	18"	125 bu/hr	22", 28", 32"
ORC 24-300	24"	175 bu/hr	36"
ORC 30-300	30"	250 bu/hr	42"
ORC 36-300	36"	300+ bu/hr	45"+

#### BRUSH CHOICES

**SF** - indicates soft brushes for gentle washing, brushing and polishing of fresh fruit or vegetables.  
**HD** - indicates stiff brushes for aggressive washing, brushing and polishing of tough skinned fruit or vegetables (recommended for cider apples)

### ROLLER INSPECTION TABLE

Move fruit or vegetables gently along while the waste falls through. The product passes personnel for inspection purposes. Available in standard length of 7' and in widths of 18", 24", and 36" with PVC rollers. Capacity of 100 bu. per hour and up.

Custom lengths available by special order.  
Manufactured in Conway by our skilled workers.

**Other sizes available by special order.**

**We can manufacture to your specifications.**



Manufactured in Conway, MA - U.S.A.

Recommended size for presses

**ORC 18-200-7** - 7' x 18" wide • 22", 28", 32" press

**ORC 24-200-7** - 7' x 24" wide • 36", 42" press

**ORC 36-200-7** - 7' x 36" wide • 45" and larger press

WE ALSO SUPPLY ROTARY TABLES, ABSORBER TABLES, BIN DUMPERS AND FEED BELTS

PACKLINE/JAFFREY PRESS



A home style all wood cider press completely operated by hand. Make your own cider, involve your family and friends and experiment with different fruit juices. All holes are pre-drilled for ease of assembly. A 1/2" socket wrench, 1/2" box wrench, screwdriver and a hammer are needed for tools. Complete instructions

are provided and it takes a few minutes to assemble. Complete press supplied with grinder. Makes 3-5 gallons/hour.

#### JAF 8400 - COMPLETE PRESS

SOME ASSEMBLY REQUIRED. ALL PARTS INCLUDED. UNITS SHIPPED UPS.

JAF 8400 • 113 lbs.



JAF 8025C Grater Only

#### OPTIONS AND ACCESSORIES

**NYLON PRESS BAG**  
JAF 8035

**ADJUSTABLE WHEELS**  
JAF 8040

**WOOD HOPPER**  
JAF 8046H

**POXY COAT**  
JAF 8050Q

**EZ-DO POLY GEL**  
JAF 8055

**GRINDER ONLY**  
JAF 8025C

**GRAPE/SOFT FRUIT PRESS**  
**TABLE TOP MODEL**  
**(PRESS ONLY)**  
**Not pictured.**  
JAF 8030

See our website for details

# Complete Cider Press Upgrade



Wooden press - Palmer Design, manufactured by Orchard Equipment & Supply Co.

## Upgrade your wood press

- Conversion of all wood to steel frame members
- Conversion of all juice contact surfaces to stainless steel or food grade plastic
- Steel components painted "OESCO" green



Rebuilt steel and stainless steel press - Manufactured by OESCO

# Sanifed Pump Upgrade



Jabsco Brass pump

## Upgrade to all stainless pump

- Conversion to all stainless pump body
- Tri clamp fittings
- Pump is easy to disassemble - Easy to clean - Easy to replace
- Available as a kit for you to install



Liverani Pump

## Hydraulic Upgrades



### Convert to new Simplex system

- Compact, self-contained unit
- Two speed operation with single pump
- Reservoir/motor/pump - all one unit

Units for all size presses available

**NEW**

## SS Concave

OESCO's stainless steel one-piece concave completely eliminates jamming of apples caused by pitted cast iron concaves!

Easily installed with no change to existing frame.



## Additional Upgrade Suggestions ...

Change your wood elevator to a new stainless steel elevator. **See page 128**



Replace wood grater and elevator boxes with stainless steel versions.



Stainless steel grater frames are available to replace your old steel frame.

Welding fabrication in process at OESCO.



**Contact us for upgrade information & pricing**



### ORCHARD BAG FILTER ASSEMBLY

Filter for juice designed as a gravity drop assembly. Consists of a 7" celcon adapter head, tapped 1 1/2" NPT (F) and a 7"x16" bag strainer with snap ring which snaps onto the head. Order both pieces for complete unit. Bag filters available separately.

- CAL 8086K - Adapter head only
- CAL 7859K - 100 micron 16" L Bag
- CAL 7628K - 150 micron 16" L Bag
- CAL 7775K - 200 micron 16" L Bag
- CAL 7843K - 5 micron x 32" long bag
- CAL 7848K - 100 micron x 32" long bag
- CAL 7772K - 150 micron x 32" long bag
- CAL 7776K - 200 micron x 32" long bag
- CAL 7788K - 400 micron x 16" long bag
- CAL 7792K - 800 micron x 16" long bag

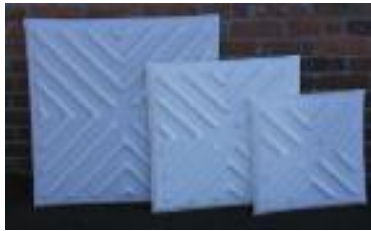

### PLASTIC CIDER PRESS RACKS

Formed and shaped polyethylene rack designed to nest inside each other. All the juice comes to the outside of the rack and runs off. Easy to clean and sanitize. Fits any rack & cloth press. Remove outer lip for the bottom rack.

- DAY 17"x17" 17" sq. rack
- DAY 22"x22" 22" sq. rack
- DAY 24"x24" 24" sq. rack
- DAY 28"x28" 28" sq. rack
- DAY 32"x32" 32" sq. rack
- DAY 36"x36" 36" sq. rack
- DAY 45"x45" 45" sq. rack



### SYPHON FILLER

An economical way of filling plastic jugs; will keep one person busy removing full jugs and putting empty ones in place. Handles any size container. Liquid source must be above this unit. Has float valve to control Liquid Level. Capacity 4 to 15 containers per min. depending on size of container and operator ability.

**SET SY1 • All Parts Available**

### Rubber Apron

Heavy duty brown rubber apron with bib. Cotton neck and waist ties. Reinforced stitching at edges. 36" x 56" L

An excellent choice for food/produce handling. Resistant to fats, oils, grease, chemicals, punctures and abrasion.

**BOS A1**



### PRESS CLOTH

For hydraulic rack & cloth juice presses

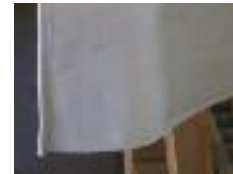

Polypropylene thread cloth for use in juice production. Excellent strength and wear characteristics. DO NOT DRY IN HIGH HEAT. DO NOT EXPOSE TO CONTINUOUS SUNLIGHT. First rinse must be in cold water. Available sewn or bulk.

#### Press Cloth Sizes:

- ORC 30x30** 30"x30", For 17" press
- ORC 40x40** 40"x40", For 22" press
- ORC 50x50** 50"x50", For 28" press
- ORC 60x60** 60"x60", For 32" press
- ORC 66x66** 66"x66", For 36" press
- ORC 72x72** 72"x72", For 42" press
- ORC 80x80** 80"x80", For 45-55" presses

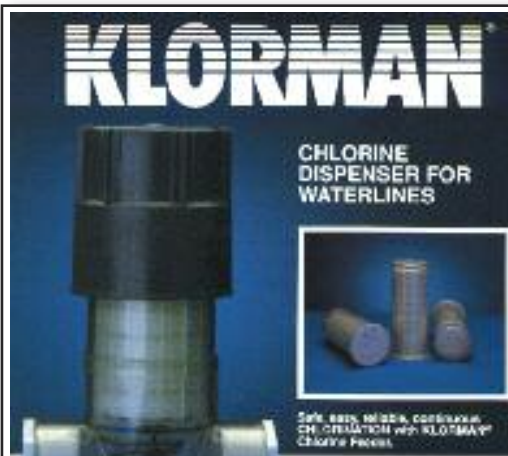

Klorman® Automatic Chlorine Dispenser uses Hypochlor cartridges (calcium hypochlorite) to provide an exceptionally reliable and effective means of safe chlorination of agricultural water compared to liquid bleach (sodium hypochlorite).

### GOOD FOR IN-LINE CHLORINE DOSING IN CIDER PRODUCTION

- Chlorine dosing regulated by turning cap to depress basket into waterflow.
- Basket containing chlorine tablet
- Water flows gently over chlorine tablets in bottom of basket. Chlorine dosing is dependent on depth of basket in water.

CALL FOR MORE INFORMATION ON INSTALLATION OF KLORMAN® SYSTEMS IN CIDER OR AGRICULTURAL SYSTEMS

Includes standard dispenser, 1 cartridge and 1 vial of chlorine test papers.

### SET KLORMAN-DISP

Hypochlor Cartridges, individually or box of 4 hypochlor cartridges (order 4)  
**KLO HSC-100**



### CHLORINE TEST PAPERS

Chemically treated paper strips change color to indicate sanitizer level. 200 test strips and color chart in a waterproof plastic vial.  
**LMC 4250BJ**



Many of our items are sewn on the OESCO premises



### APPLE PEELER

Peels, slices and cores all in one operation. The blade automatically adjusts to the contour of the apples, pears or potatoes.

**BTB A501 - Clamp Style (pictured)**

**BTB A505 - Suction Lock Style (not pictured)**



### WHITE OAK CIDER & WINE KEGS

New oak kegs available paraffin lined or clear sap wood, charred. These high quality kegs are hand crafted with six galvanized hoops installed for durability. GIB 2, 3, 5,10,15, and 30 gallon available.

### Used Whiskey Barrels

50 gallon charred oak bourbon whiskey barrels used one time only for whiskey. **Call for availability.**  
**ORC 50Gallon**

### BUNGS

Made of soft wood for maximum adaptability, even to out-of-round holes. **See price list for sizes.**

### 5 GALLON KEG DISPENSER

5 gallon keg dispenser with a lacquer finish, wood cover, removable poly liner and plastic faucet.  
**ORC 5PLKEG • 26 lbs.**

### JUICE/ PRODUCT HOSE

FDA approved PVC hose and tube sized by I.D. X OD  
MCG ABH 02017 - 1/4"x3/8"  
MCG ABH 02027 - 3/8"x1/2"  
MCG ABH 02036 - 1/2"x5/8"  
MCG ABH 02046 - 5/8"x7/8"  
MCG ABH 02053 - 3/4"x1"  
MCG ABH 00062 - 1"x1 1/4"  
MCG ABH 00071 - 1 1/4"x1 3/4"

Clear wall with braid Hose X psi rating, Size is ID  
FLO 2H5015/0375 - 3/8" clear braid - 225psi  
FLO 2H5015/050 - 1/2" clear braid - 200psi  
FLO 2H5015/0625 - 5/8" clear braid - 200psi  
FLO 2H5015/075 - 3/4" clear braid - 150psi  
FLO 2H5015/100 - 1" clear braid - 125psi  
FLO 2H5015/125 - 1 1/4" clear braid - 100psi  
FLO 2H5015/150 - 1 1/2" clear braid - 100psi

Clear wall with rib support • Size is ID  
FLO 2XWT100-100 - 1"  
FLO 2XWT125-100 - 1 1/4"  
FLO 2XWT150-100 - 1 1/2"  
FLO 2XWT200-100 - 2"

### PRESSURE SENSITIVE LABELS Imprinted labels for cider use.

Optional custom printed Sweet Cider labels are available.

**ORC PS1** - Sweet Cider label with custom imprint. 500/roll; min. 5,000 labels. Call for quote. Label measures 2 1/2" x 3 3/4". "Sweet Cider, Keep Refrigerated, Made From Sound Ripe Apples"

**ORC PS2** - Sweet Cider label. 500/roll; priced per 1,000 labels. Label measures 2 1/2" x 3 3/4". "Sweet Cider, Keep Refrigerated, Made From Sound Ripe Apples"

**ORC PS4** - Sweet Cider label (small size). 1,000/roll; min. 1,000 labels. Label measures 1 1/2" x 2 1/2". "Sweet Cider, Keep Refrigerated, Made From Sound Ripe Apples"

**DAY CWL** - Warning label. Required by HACCP. 1000/roll, min. 1,000 labels. Label measures 2" x 1". "Warning: This product has not been pasteurized and therefore may contain harmful bacteria that can cause serious illness in children, the elderly, and persons with weakened immune systems."

### PRESERVATIVE

#### SORBIC (POTASSIUM SORBATE)

Food and beverage preservative added to product per label "Keep Product Under Refrigeration."  
**ORC C50** - 50lb. Bag only

### PRESS AIDS

#### SILVACEL

Shredded wood prevents pomace slipping and sticking to the cloth. Use with over mature fruit to assist in production.

**ORC C40** - 45 lb. Bag only

#### SUPERCEL (DIATOMACEOUS EARTH)

Filter agent use as labeled for filters and/or cloth in juice, syrup and food.

**ORC C-60** - 50 lb. Bag only

#### RICE HULLS

Provides channels for juice to flow freely. Effective in keeping racks from sliding sideways. Helps with maximum yield when pressing grapes in a Lancman press.

**ORC RICE-HULLS** - 45 lb. Bag only

### FOOD GRADE LUBE

#### SUPER FML GREASE

USDA approved white grease for use in juice and food production machinery. Standard grease tube only.

**ORC C20** - tube (10 tubes/case)

#### PETRO-GEL (TECHNICAL WHITE)

Tasteless, odorless lubricant for stainless steel fittings and machinery.

**ORC C-25** - tube only

#### PARAFFIN WAX

High grade paraffin in 10lb. blocks  
**ORC C-10** - 10 lb. Blocks only

### CIDER EQUIPMENT CLEANER

Chlorinated, alkaline detergent cleans, sanitizes and deodorizes cider processing and food processing equipment. Works for CIP or hand brush operations. Acceptable cleaner/sanitizer by USDA and FDA. It is a strong oxidizing agent.

**ORC C30** - (Oakite) sold by the pound

### Apple Cookbook

Over 140 versatile recipes for every meal all year long. *By Olwen Woodier*  
**BOK 67389**

### Maple Syrup Cookbook

Sweet and savory recipes, revealing maple syrups earthy qualities. *By Ken Haedrich*  
**BOK 67404**

**NEW**

### SULPHUR BURNING BUNG

Use this bung to hang a burning sulphur strip in the barrel to sweeten the barrel.

**ORC C125**

### SULPHUR BURNING STRIPS

Preserve your barrels and avoid spoilage by burning sulphur in barrel after it is emptied. Simply rinse barrel, then insert sulphur strip and burn. After burning, bung tight and interior sweetness is preserved for next season. Strips sold individually.

**LDC 8310**

### TWIN BUBBLE AIR LOCK ASSEMBLY

A twin bubble fermentation air lock assembly consists of two bubbles in an air lock tube which is inserted into a rubber stopper. **\*STOPPERS SOLD SEPARATELY.**

**LDC 4602**

\*Specify size of stopper.

See price list for stopper sizes.



### STAINLESS STEEL FAUCET

Fits standard 1/2" pipe fitting; easily disassembled for cleaning. Lock open, snap action closing, simple to operate, long lasting.

**TOM ST3**



### THERMO-PLASTIC FAUCET

Same as above but completely fabricated of plastic. 1/2" pipe fitting.

**TOM SPW**



### CORKLINED FAUCET

Quality wood construction and deep oil impregnation. 7 1/2"

**LDC 8404** • 12 oz.



**Payment:** We accept Mastercard, Visa and Discover credit cards. Your credit card will be charged at the time of shipment, unless other arrangements have been made. To be considered for Net 30 terms, call us to request a credit application. Allow 2 - 3 weeks to process once the signed application is returned. We also accept payment in advance of shipment.

**Return Policy & Instructions:** Call our office requesting authorization for a return. Supply the invoice number and the reason you are requesting the return. If you believe your item should be covered under warranty, describe the defect. Once the product is received, we will contact the manufacturer and credit your account based on the outcome of their analysis of the product.

**Sales Tax:** We collect sales tax in Massachusetts, Connecticut, and Rhode Island. For those eligible for exemption, send a signed copy of your current sales tax exemption certificate at least 5 days before your order is to ship.

**Shipping:** Unless drop shipped from a supplier, your package will ship from Conway, Massachusetts. We make every attempt to ship your order within 24 hours of its receipt. Please request if you want your order shipped complete, or in the case of a backorder being necessary, ship all available and backorder. Shipping charges will be added to your invoice. Oversized items not eligible for UPS shipments will be either delivered by OESCO or by truck freight. Please inquire at time of order. Next day air services are available upon request via UPS or USPS.

**Special and Drop Ship Orders:** Special orders for product not normally stocked by OESCO are non-refundable and non-returnable. Case lot quantities will apply. Prepayment is required. Drop ship orders from the manufacturer may carry additional handling charges. Cancellation of these orders will result in a 15% restock charge plus any freight charges incurred.

**Website:** We have a great website that is updated with products added after the publishing of this catalog. Check out [www.oescoinc.com](http://www.oescoinc.com)!

**Financing:** We offer financing options through NAEDA for equipment sales. Please contact our office for more details.

**Gift Certificates:** Gift certificates are available in amounts over \$20.00. We will include a personal note with the gift certificate if you'd like us to mail it for you!

**Shows:** We attend many agricultural and horticultural related shows largely in the Northeast. If you are planning to attend a show, click on our website to see if we have it on our agenda. If you go to a show that you think OESCO should attend, let us know about it.

**Mailings:** We do not provide the names and addresses of our customers to any mailing source. Call us to request an updated catalog. We have ample catalogs available at trade shows, so if you'll be attending, make sure you stop to pick up one.

**Prices:** Prices are subject to change with or without notice.



Look for this symbol throughout the catalog that lets you know about a new product!

### 4 ways to order:

Phone: 800-634-5557

Fax: 413-369-4431

Online: [www.oescoinc.com](http://www.oescoinc.com)

Store : Route 116, Conway, MA

### Hours of operation:

Monday-Friday 7-5 & Saturday 7-12.

We are closed on holiday weekends & major holidays

### Did you know.....

When a customer's production is down, we provide immediate assistance to get equipment running. We will help determine the problem, then get you what's needed to get going again.

**Our first priority is to get you back up and running.**

We have a record of every invoice since we started our business over 50 years ago. We can assist you with choosing replacement parts and recalling what you bought even if you can't remember!

OESCO employs several volunteer firefighters that serve Conway's Fire Department across the street. As a benefit to the employees and the community, OESCO picks up those hours they are away from work. It illustrates the character of the company.

We do business with thousands of vendors insuring that we get the best products available at the most competitive price. Our years of experience gives us the edge in choosing well made tools and equipment to get the job done.

When you call us we answer; not a machine, but a helpful, courteous person. We like it that way.

**We are the fortunate ones - we have some of the nicest customers in the world!**

